

ALLEN & HEATH



USER GUIDE

Publication AP7085

Limited One Year Warranty

This product is warranted to be free from defects in materials or workmanship for period of one year from the date of purchase by the original owner.

To ensure a high level of performance and reliability for which this equipment has been designed and manufactured, read this User Guide before operating. In the event of a failure, notify and return the defective unit to ALLEN & HEATH Limited or its authorised agent as soon as possible for repair under warranty subject to the following conditions

Conditions Of Warranty

The equipment has been installed and operated in accordance with the instructions in this User Guide.

The equipment has not been subject to misuse either intended or accidental, neglect, or alteration other than as described in the User Guide or Service Manual, or approved by ALLEN & HEATH.

Any necessary adjustment, alteration or repair has been carried out by ALLEN & HEATH or its authorised agent.

This warranty does not cover fader wear and tear.

The defective unit is to be returned carriage prepaid to ALLEN & HEATH or its authorised agent with proof of purchase.

Units returned should be packed to avoid transit damage.

In certain territories the terms may vary. Check with your ALLEN & HEATH agent for any additional warranty which may apply.

This product complies with the European Electro magnetic Compatibility directive 2004/108/EC and the European Low Voltage Directive 2006/95/EC.

This product has been tested to EN55103 Parts 1 & 2 1996 for use in Environments E1, E2, E3, and E4 to demonstrate compliance with the protection requirements in the European EMC directive 2004/108/EC. During some tests the specified performance figures of the product were affected. This is considered permissible and the product has been passed as acceptable for its intended use. Allen & Heath has a strict policy of ensuring all products are tested to the latest safety and EMC standards. Customers requiring more information about EMC and safety issues can contact Allen & Heath.

NOTE: Any changes or modifications to the console not approved by Allen & Heath could void the compliance of the console and therefore the users authority to operate it.

ZED 12FX, 16FX & 22FX User Guide AP7085 Issue 2

Copyright © 2007 Allen & Heath Limited. All rights reserved

Allen & Heath Limited

Kernick Industrial Estate, Penryn, Cornwall, TR10 9LU, UK

<http://www.allen-heath.com>

PACKED ITEMS

Check that you have received the following:

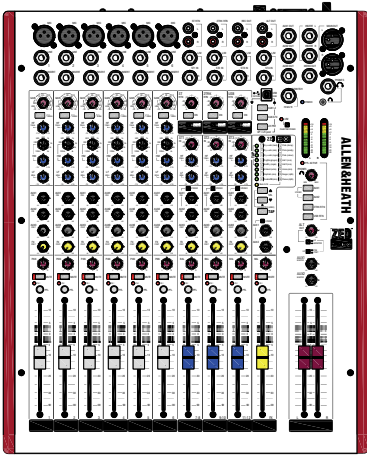

OR

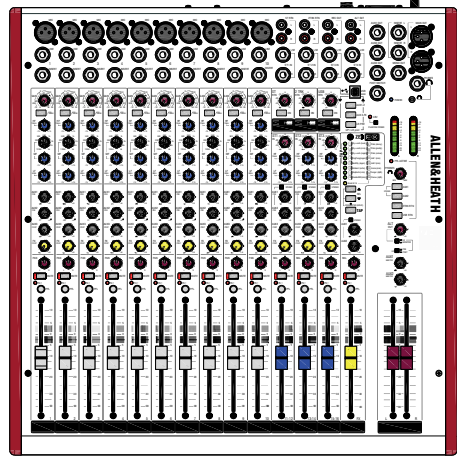

OR

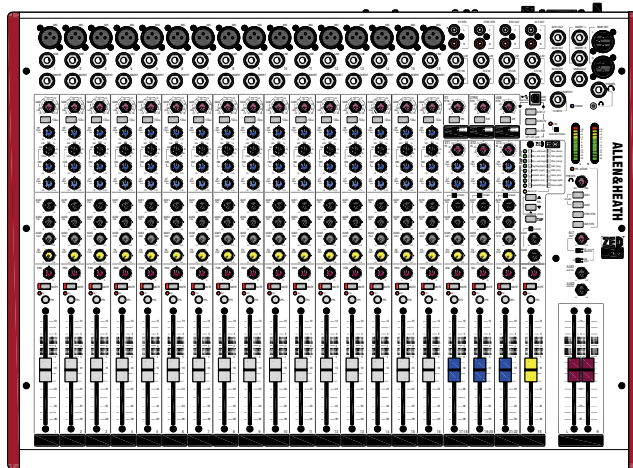

ZED-12FX, 16FX or ZED-22FX MIXER

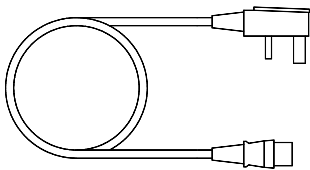

Mains Lead

Check that the correct mains plug is fitted.

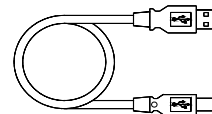

Type A-B USB Lead

To connect the ZED to your computer.

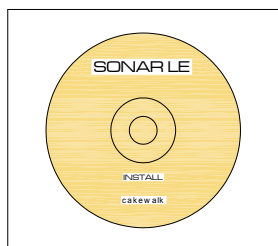

SONAR LE

Music Software Install disk.

SAFETY INSTRUCTIONS

WARNINGS - Read the following before proceeding :



ATTENTION: RISQUE DE CHOC ELECTRIQUE – NE PAS OUVRIR

Read instructions: Retain these safety and operating instructions for future reference. Adhere to all warnings printed here and on the console. Follow the operating instructions printed in this User Guide.

Do not remove cover: Operate the console with its covers correctly fitted.

Power sources: Connect the console to a mains power unit only of the type described in this User Guide and marked on the rear panel. Use the power cord with sealed mains plug appropriate for your local mains supply as provided with the console. If the provided plug does not fit into your outlet consult your service agent for assistance.

Power cord routing: Route the power cord so that it is not likely to be walked on, stretched or pinched by items placed upon or against it.

Grounding: Do not defeat the grounding and polarisation means of the power cord plug. Do not remove or tamper with the ground connection in the power cord.



WARNING: This equipment must be earthed.

Water and moisture: To reduce the risk of fire or electric shock do not expose the console to rain or moisture or use it in damp or wet conditions. Do not place containers of liquids on it which might spill into any openings.

Ventilation: Do not obstruct the ventilation slots or position the console where the air flow required for ventilation is impeded. If the console is to be operated in a rack unit or flightcase ensure that it is constructed to allow adequate ventilation.

Heat and vibration: Do not locate the console in a place subject to excessive heat or direct sunlight as this could be a fire hazard. Locate the console away from any equipment which produces heat or causes excessive vibration.

Servicing: Switch off the equipment and unplug the power cord immediately if it is exposed to moisture, spilled liquid, objects fallen into the openings, the power cord or plug become damaged, during lightning storms, or if smoke, odour or noise is noticed. Refer servicing to qualified technical personnel only.

Installation: Install the console in accordance with the instructions printed in this User Guide. Do not connect the output of power amplifiers directly to the console. Use audio connectors and plugs only for their intended purpose.

SAFETY INSTRUCTIONS

Important Mains plug wiring instructions

The console is supplied with a moulded mains plug fitted to the AC mains power lead. Follow the instructions below if the mains plug has to be replaced. The wires in the mains lead are coloured in accordance with the following code:



TERMINAL		WIRE COLOUR	
		European	USA/Canada
L	LIVE	BROWN	BLACK
N	NEUTRAL	BLUE	WHITE
E	EARTH GND	GREEN & YELLOW	GREEN

The wire which is coloured Green and Yellow must be connected to the terminal in the plug which is marked with the letter E or with the Earth symbol. This appliance must be earthed.

The wire which is coloured Blue must be connected to the terminal in the plug which is marked with the letter N.

The wire which is coloured Brown must be connected to the terminal in the plug which is marked with the letter L.

Ensure that these colour codes are followed carefully in the event of the plug being changed.

General Precautions:

Damage : To prevent damage to the controls and cosmetics avoid placing heavy objects on the control surface, scratching the surface with sharp objects, or rough handling and vibration.

Environment : Protect from excessive dirt, dust, heat and vibration when operating and storing. Avoid tobacco ash, smoke, drinks spillage, and exposure to rain and moisture. If the console becomes wet, switch off and remove mains power immediately. Allow to dry out thoroughly before using again.

Cleaning : Avoid the use of chemicals, abrasives or solvents. The control panel is best cleaned with a soft brush and dry lint-free cloth. The faders, switches and potentiometers are lubricated for life. The use of electrical lubricants on these parts is not recommended. The fader and potentiometer knobs may be removed for cleaning with a warm soapy solution. Rinse and allow to dry fully before refitting them.

Transporting : The console may be transported as a free-standing unit or mounted in a rack or flightcase. Protect the controls from damage during transit. Use adequate packing if you need to ship the unit.

Hearing : To avoid damage to your hearing do not operate any sound system at excessively high volume. This applies particularly to close-to-ear monitoring such as headphones and in-ear systems. Continued exposure to high volume sound can cause frequency selective or wide range hearing loss.



CONTENTS

Thank you for purchasing your Allen & Heath ZED mixer. To ensure that you get the maximum benefit from the unit please spare a few minutes familiarizing yourself with the controls and setup procedures outlined in this user guide. For further information please refer to the additional information available on our web site, or contact our technical support team.

<http://www.allen-heath.com>

<http://www.allen-heath.com/zed>

<http://www.myspace.com/thezedspace>

Warranty.....	3
Packed Items	4
Safety Instructions.....	5
Contents	7
Panel Drawings	8
Introduction to ZED-12, 16 & 22FX	11
Specifications.....	12
Dimensions.....	13
Block Diagram	14
Mono Input Channel	15
Stereo Input Channel ST1.....	18
Stereo Input Channel ST2, 3 & FX.	20
Effects Processor.....	21
Master Section.....	23
USB Connection.....	25
SONAR LE software introduction.	26
SONAR LE configuration.....	27
Pro Tools9 on a Mac with ZED.....	28
Application Information—Live.....	29
Application Information—Studio ...	30
Wiring Notes.....	31
Product Support.....	32

PANEL DRAWINGS: 12FX

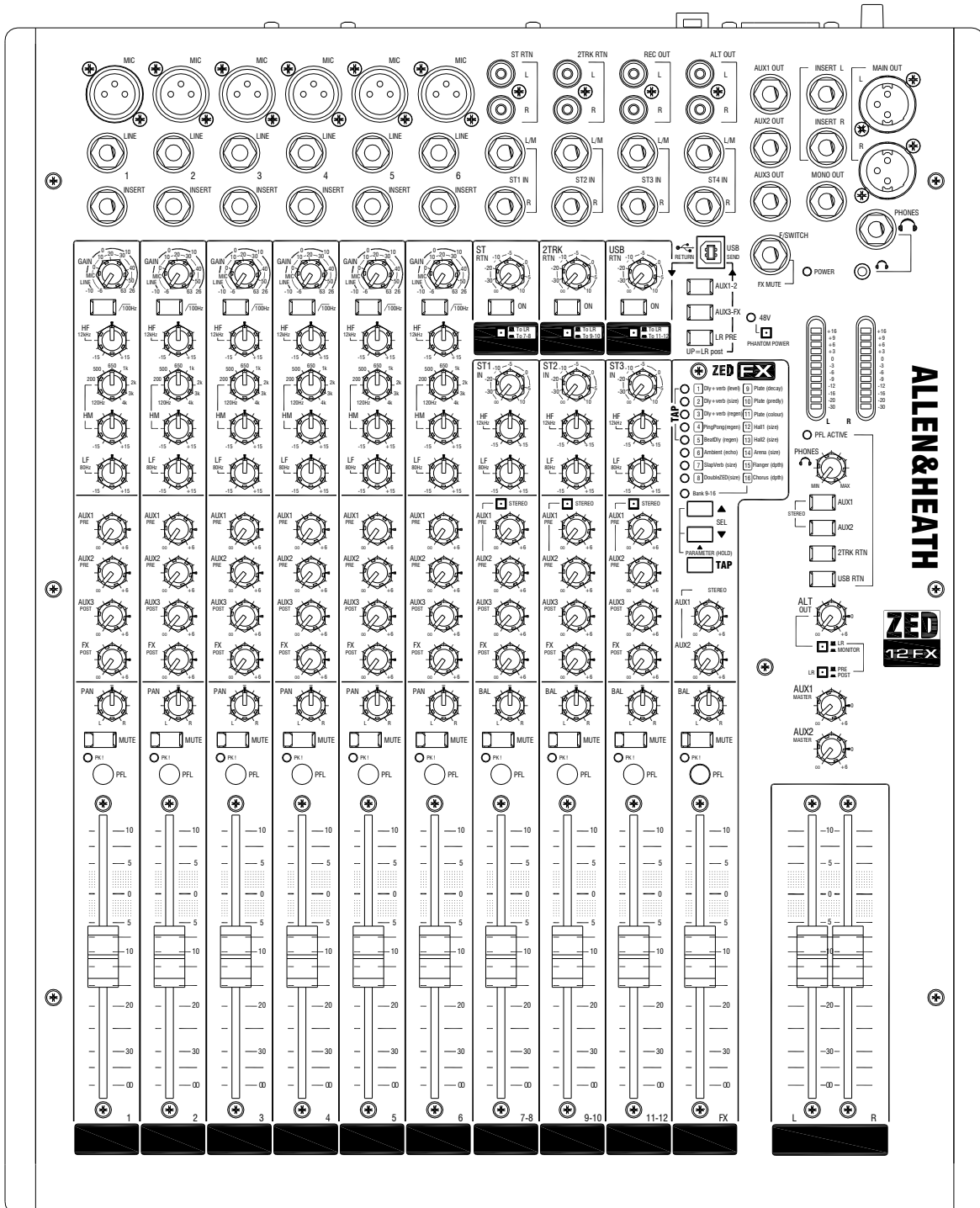
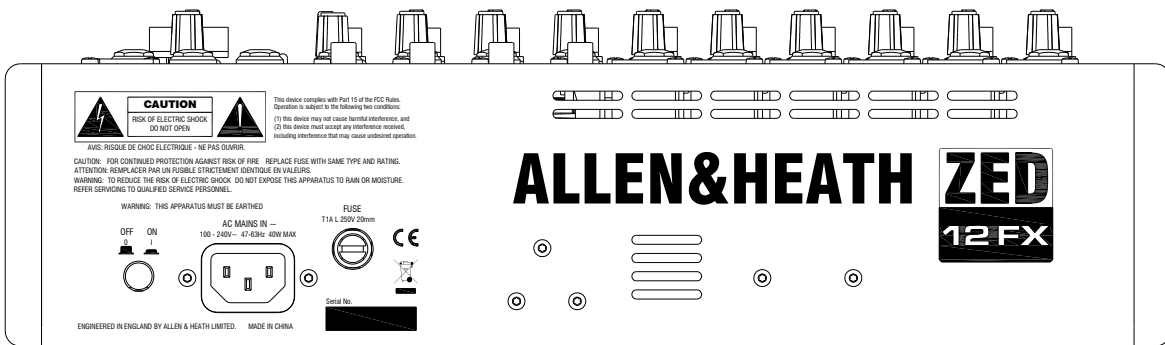

PANEL DRAWINGS: I6FX

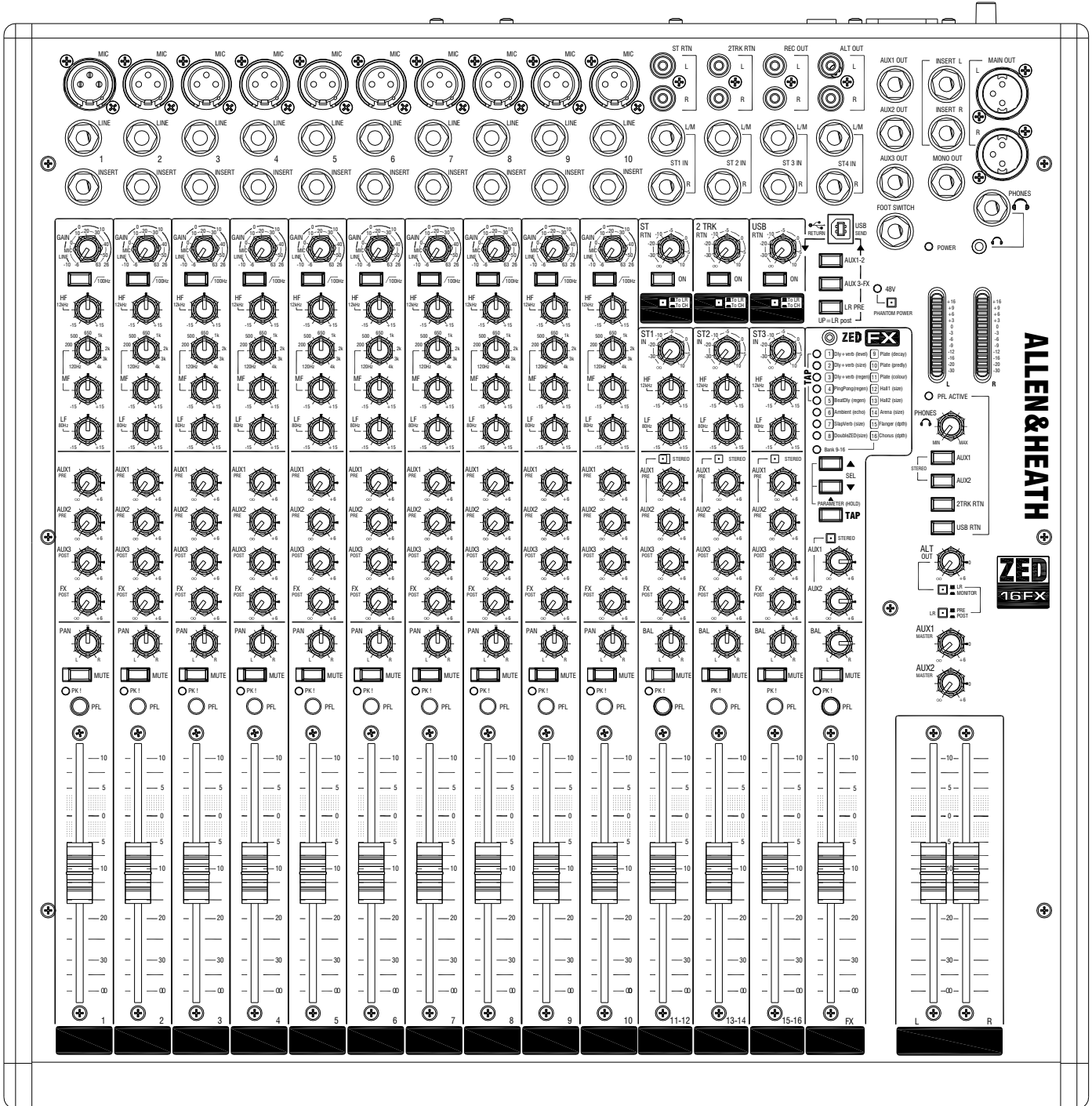
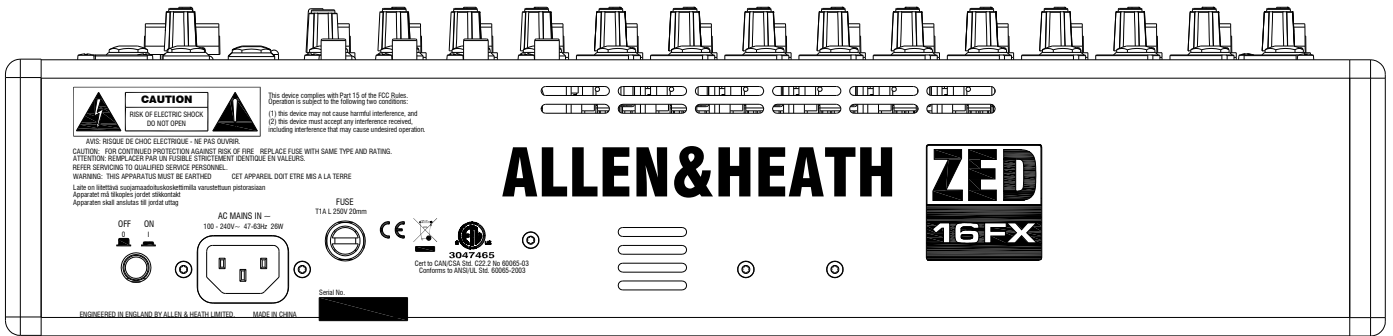

PANEL DRAWINGS: 22FX

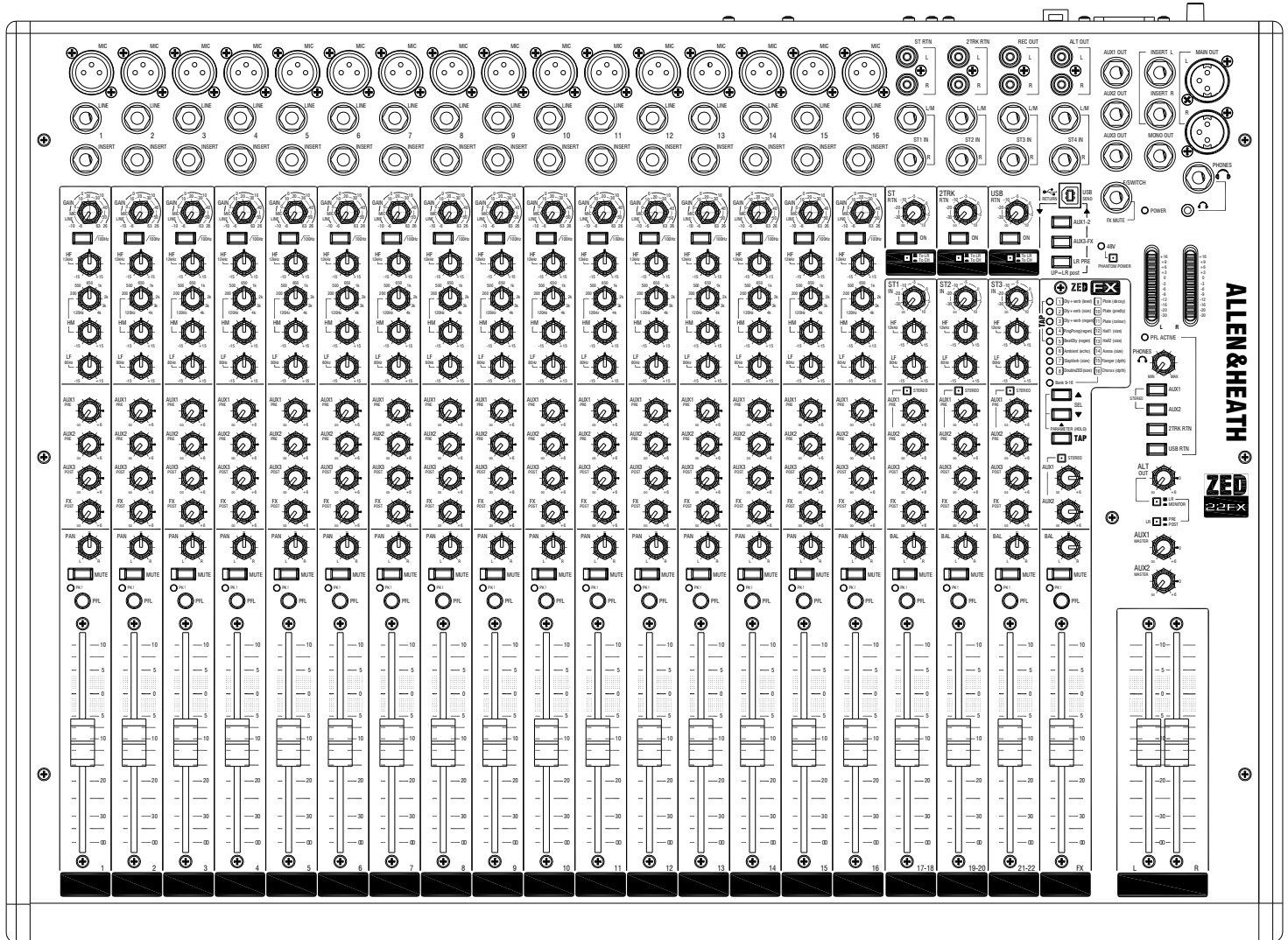
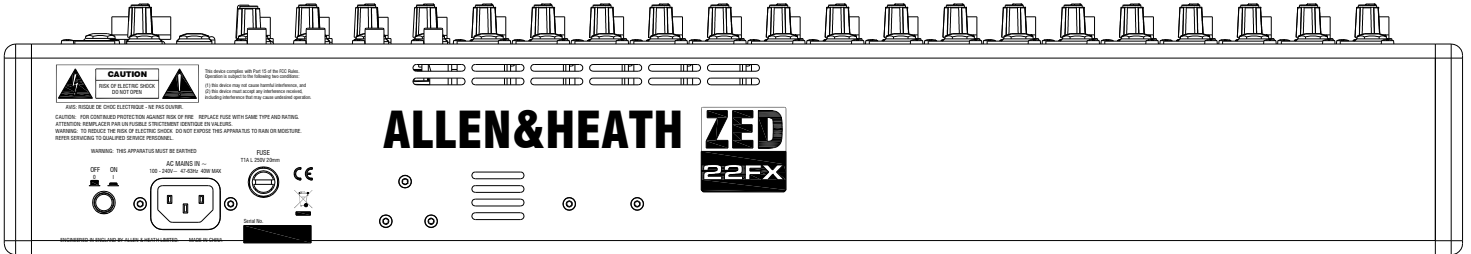

INTRODUCTION TO THE ZED-12FX, 16FX & 22FX

The following is a technical overview of ZED, if you want to, please skip to the next section.

The Allen & Heath ZED series mixers have been carefully and lovingly designed in the beautiful county of Cornwall in the UK and is manufactured alongside a wide range of professional audio mixing consoles. Many of the components used in ZED are exactly the same as in the larger Allen & Heath products and the construction methods are also very similar — utilising individual vertically mounted channel circuit boards with each rotary control fixed with a metal nut to the front panel. This provides a very robust product that will resist damage and give years of reliable use. It also makes servicing much easier should it be required, with the ability to remove one particular channel from the mixer at a time, or easily change a fader.

The audio circuitry is based on years of continual development and refinement, the performance of all the elements within the mixer scrutinised and perfected to ensure the very best sound quality possible.

Multi-application:

ZED's are great for live mixing! Their layout makes ZED's very easy to use and the 100mm faders give much better control of the mix compared to most products at a similar price.

They are also great for recording, either a live show or an audio project at home can be built up track by track and studio monitor speakers can be fed from the Alt Outputs.

ZED mixers are also ideal for teaching establishments, houses of worship, hotels and conference centres where their ease of use and robust qualities make them a top choice.

Mic/Line Pre-amps:

Based on the pre-amps from the PA series, the ZED-12FX, 16FX & 22FX pre-amps use a two stage design, with carefully controlled amounts of gain in each stage. When amplifying the signal from the XLR input, the gain range is huge (69dB of range to be exact) and is very evenly distributed around the gain control, meaning better control of signal level. Most of the gain comes from the first stage, so unwanted noise is kept to a minimum. There is no "pad" switch, or pad circuit — line level signals are simply plugged into the second stage of the pre-amp by using the line input jack socket. This has the great advantage of lower noise when using the line input. (It is common to attenuate line level signals, the amplify them back up again which can give more noise or hiss).

EQ:

The ZED series mixers are equipped with a 3-band equaliser circuit on each mono input and a 2-band EQ on the stereo channels. The frequency and response of each has been carefully chosen to give the maximum performance when using the EQ on a variety of sources.

AUX system:

Zed 12FX, 16FX & 22fx mixers have 4 Aux buses. 3 are used for connecting external equipment such as foldback stage monitors, or external effects processors, and one is used for the internal effects processor.

Effects Processor:

Zed-12FX, 16FX & 22FX mixers have a professional quality effects processor built in which uses our own effects algorithms developed by our talented engineering staff at Allen & Heath. The effects range from classic reverbs, cascaded delay plus reverbs to shimmering flanger & chorus effects. The different effects types are selected with a simple up/down button interface and the tempo of the delay settings can be entered using the TAP button. Holding the TAP button allows the parameters of the effects to be adjusted. The audio signal to the DSP is converted using 24 bit high dynamic range converters running at 48kHz sample rate, ensuring low noise, low distortion, transparent effects.

Mono and Stereo Channels:

One of the great things about the ZED series is the number and variety of things you can plug in. In addition to the mono channels there are three stereo channels, each with a main stereo input on jack sockets, two of them have the ability to take additional stereo inputs from phono sockets, the third can take the USB audio input. Flexibility gives you control.

USB:

Getting audio to and from a computer easily is now a common requirement for live sound and music production. The way we have implemented this on ZED is super-flexible and super-easy! No longer do you need to fiddle around the back of your computer to get to the soundcard inputs, only to find that the levels are all wrong and noisy. Just plug in a USB lead to your ZED, select the USB routing on the mixer and the device on your computer and that's it! Quality audio to and from your PC or MAC.

As you can tell, we're very proud of this product we hope you like it too.

SPECIFICATIONS

Operating Levels

Operating Levels	
Input	
Mono channel (XLR) Input	+6 to -63dBu for nominal (+17dBu in max)
Mono channel Line Input (Jack socket)	+10 to -26dBu (+30dBu maximum)
Insert point (TRS Jack socket)	0dBu nominal +21dBu maximum
Stereo Input (Jack sockets)	0dBu nominal (control = Off to +10dB)
Stereo input (phono sockets)	0dBu nominal (control = Off to +10dB)
Output	
L, R & Mono Outputs (L&R XLR, Mono Jack)	0dBu nominal. +21dBu maximum.
Aux Outputs (Jack sockets)	0dBu nominal. +21dBu maximum.
Alt Outputs (phono sockets)	0dBu nominal. +21dBu maximum.
Rec Outputs (phono sockets)	0dBu nominal. +21dBu maximum.

Frequency Response

Mic in to Mix L/R Out, 30dB gain	+0.5/-1dB 20Hz to 20kHz.
Line in to Mix L/R out 0dB gain	+0.5/-1dB 10Hz to 30kHz
Stereo in to Mix L/R out	+0.5/-1dB 10Hz to 30kHz

THD+n

Mic in to Mix L/R Out, 0dB gain 1kHz +10dBu out	0.004%
Mic in to Mix L/R Out, 30dB gain 1kHz	0.014%
Line in to Mix L/R out 0dB gain 0dBu 1kHz	0.005%
Stereo in to Mix L/R out 0dB gain +10dBu 1kHz	0.003%

Headroom

Analogue Headroom from nominal (0Vu)	21dB
USB in & out headroom from nominal (0Vu)	14dB

USB Audio CODEC (Coder/Decoder)

USB Audio In/Out	USB 1.1 compliant 16bit.
Sample Rate	32, 44.1, or 48kHz

Noise

Mic Pre EIN @ max gain 150R input Z 22-22kHz	-127dBu
Mix L/R out, L/R faders = 0, 22-22kHz ZED-12FX	-88dBu
Mix L/R out, L/R faders = 0, 22-22kHz ZED-16FX	-86dBu
Mix L/R out, L/R faders = 0, 22-22kHz ZED-22FX	-84dBu

Dimensions

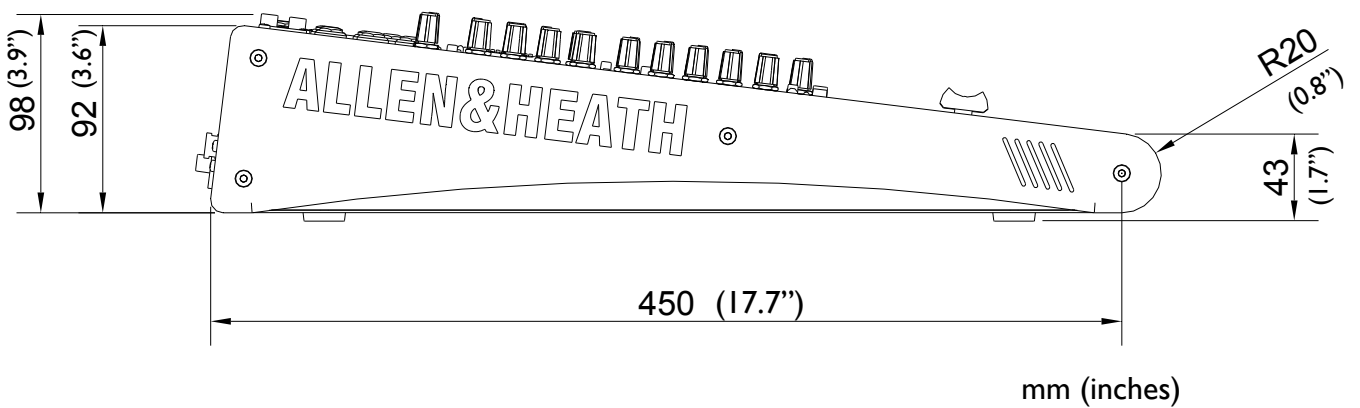
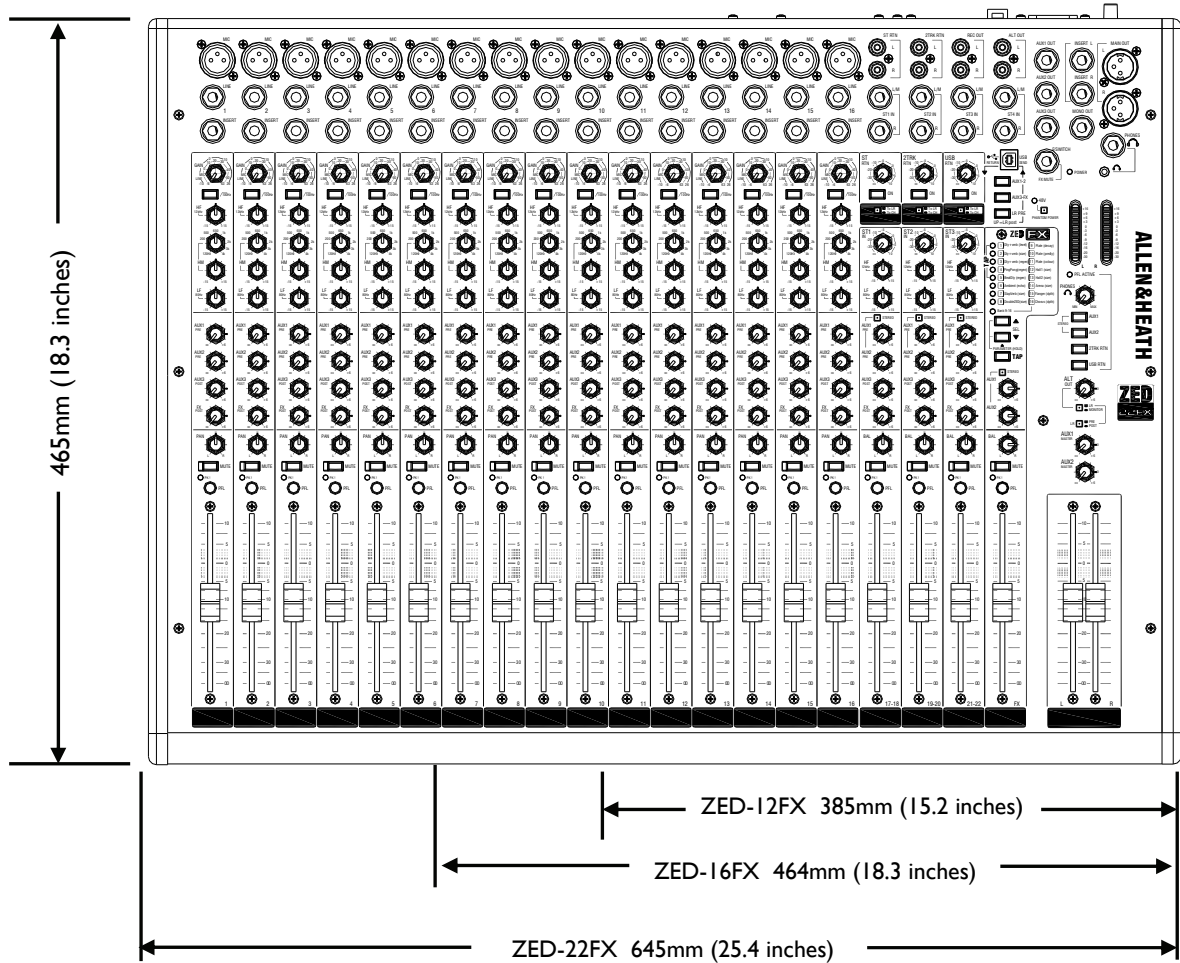

Weight

	ZED-12FX	ZED-16FX	ZED-22FX
Unpacked	6.5kg (14.3 lb)	8.5kg (18.7 lb)	10.5kg (23.1 lb)
Packed	10.5kg (23.1lb)	13kg (28.6 lb)	15kg (33 lb)

A rack mounting kit is available for ZED-12FX. The part number is: ZED1402-RK19

A rack mounting kit is available for ZED-16FX. The part number is: ZED1802-RK19

BLOCK DIAGRAM

ZED 12FX, 16FX & 22FX BLOCK DIAGRAM

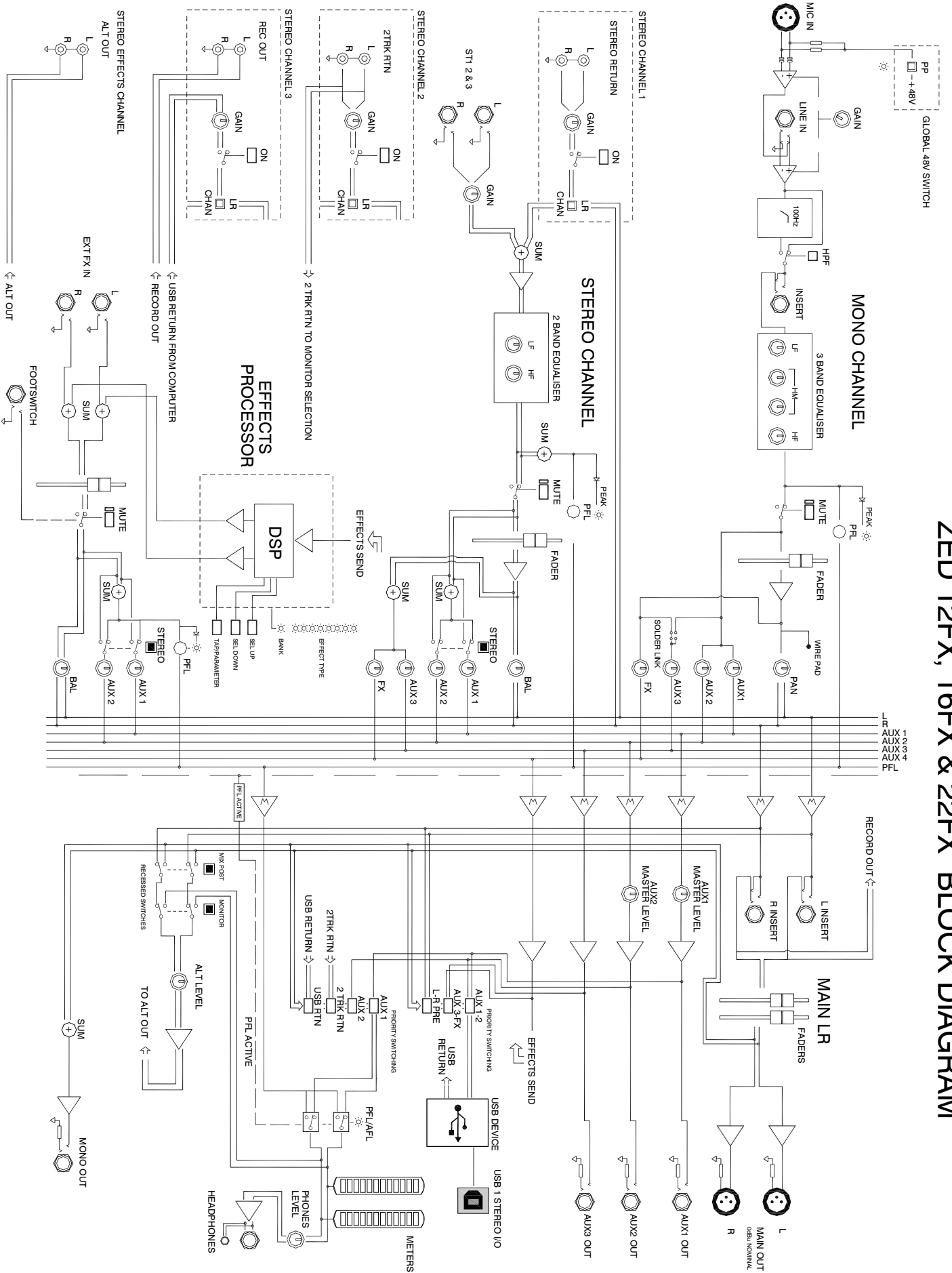

MONO INPUT CHANNEL



Mic Input Socket

Standard 3-Pin XLR socket wired as Pin 1=Chassis, Pin 2=hot (+), Pin 3=Cold (-).

Line Input Jack Socket

Standard 1/4" (6.25mm) Jack socket for balanced or unbalanced line level signals. Wired Tip=Hot(+), Ring=cold (-), Sleeve=Chassis. The Line input overrides the Mic input, so if you want to hear something plugged in to the xlr socket, make sure nothing is plugged into the Line input.

Insert Jack Socket

Standard 1/4" (6.25mm) Jack socket for unbalanced insert send and return signals. Wired Tip=send, Ring=return, Sleeve=Chassis. Nominal level is 0dBu. The insert point is after the 100Hz filter and before the EQ.

Gain Control

This adjusts the gain of the input amplifier to match the signal level of the input. The gain is varied from -6dB (attenuation) to +63dB for signals plugged in to the xlr socket (Mic Input) and -10dB to +26dB for signals plugged into the Line input jack.

100Hz Hi-pass Filter

The Hi-pass filter is used for reducing pop noise and rumble from microphone signals. It is a 2-pole (12dB per octave) filter with a corner frequency set at 100Hz. The filter affects signals from both Mic XLR and Line jack socket.

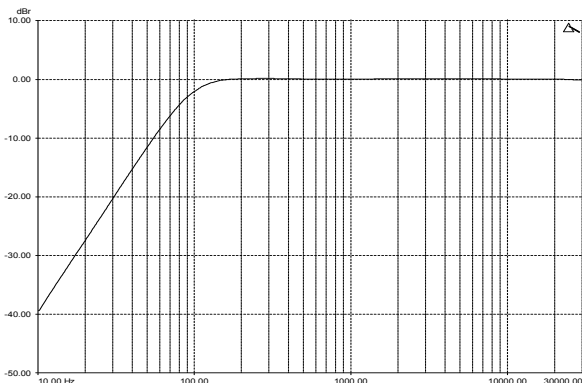

MONO INPUT CHANNEL

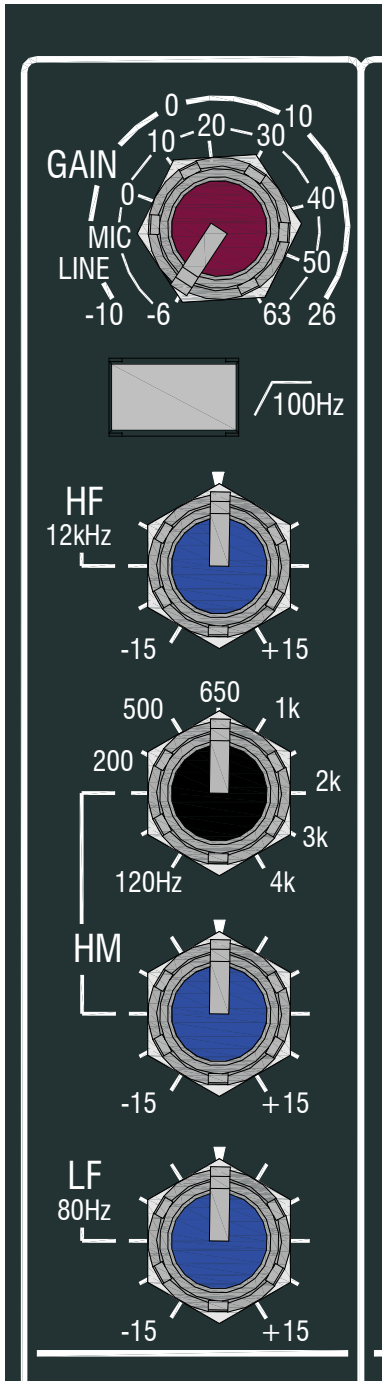

HF EQ

The HF (High Frequency) equaliser affects the frequency response of the higher audible frequencies. The corner frequency of 12kHz is around 3dB from the maximum cut or boost of the circuit. It has plenty of gain and actually gives slightly more than the +/-15dB legend suggests.

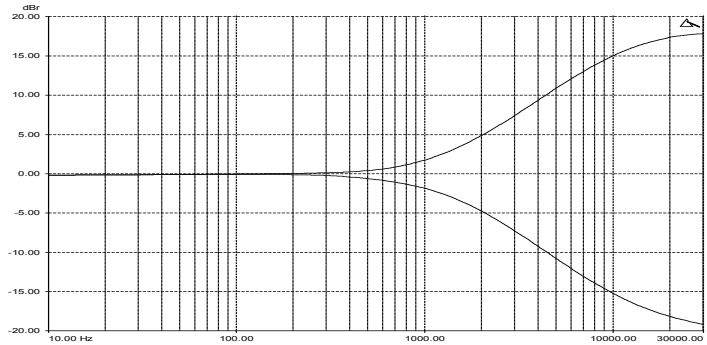

MF EQ

The MF (Mid Frequency) equaliser affects the middle of the audible frequency range. The frequency graduations on the sweep control are the centre frequencies of the EQ. The range has been carefully chosen to cover “boomy” frequencies around 120Hz to 250Hz which may need cutting back, or a lift at 2 to 3kHz may be required for microphone intelligibility.

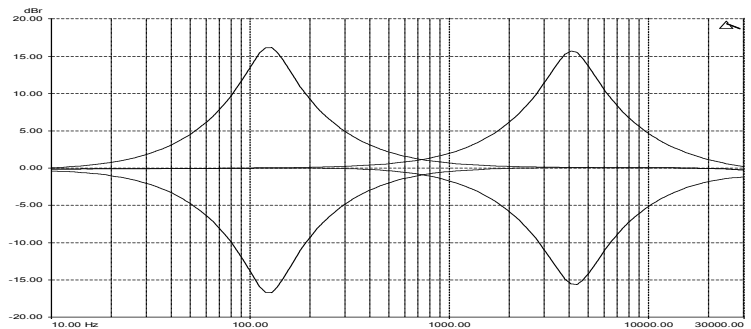

LF EQ

The LF (Low Frequency) equaliser affects the response at the low end of the audio range. The graph shows the response of the LF EQ at maximum cut and boost. The corner frequency is 80Hz.

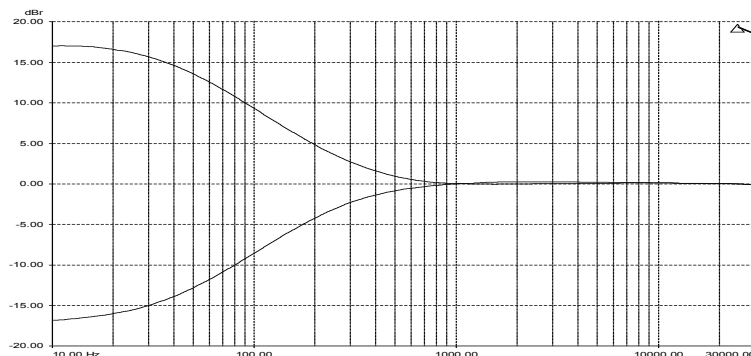

MONO INPUT CHANNEL

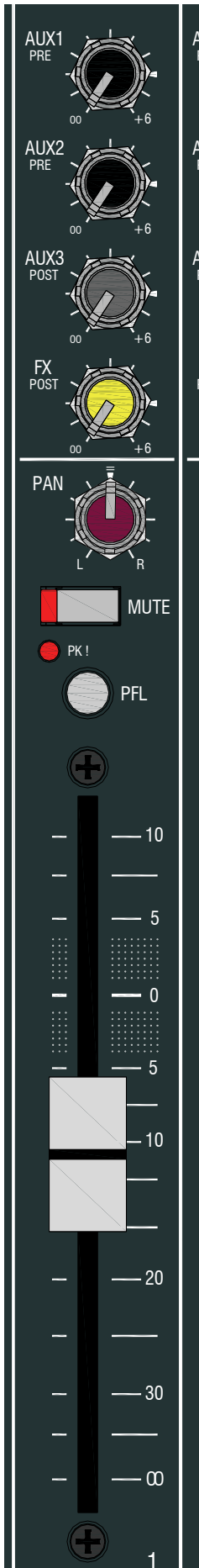

Auxes 1 & 2

Each of these controls sends a signal to an auxiliary bus. The signal is sourced pre-fade which means that the level is independent of, and unaffected by the fader. Auxes 1 & 2 are primarily used for foldback monitoring purposes, as the fader does not affect the level. They can also be used as feeds for recording and are available sources to the USB interface for this purpose.

These sends are affected by the Mute switch, so muting the channel will also mute the Aux sends.

The control varies the signal level to the bus from off (fully attenuated) to +6dB, with unity gain at the arrow.

There are master level controls for the Aux 1 & 2 outputs situated in the master section of the mixer.

Auxes 3 & FX

These are post-fade sends, which means that the signals are affected by the channel fader. Primarily used for effects sends, the aux signal will reduce if the fader is pulled down so keeping the correct proportion of the effect.

Muting the channel will also mute the Aux sends, and the send controls have 6dB gain fully clockwise.

There are no master level controls for Aux 3 output or the FX mix bus.

PAN

The pan control adjusts how the signal from the mono input channel is shared between the left and right buses and subsequently the main stereo outputs. Set to the mid position, equal amounts of signal are fed to left and right, with pan set to L, none is sent to the Right bus.

Mute Switch

This mutes or cuts the signal to the left & right buses and the Aux buses. A rectangular LED illuminates to show the Mute switch is pressed.

PFL Switch & PK! LED

The PFL (Pre-Fade Listen) switch sends the channel signal to the PFL bus and subsequently to the headphones and the main L R meters. Used for checking the audio signal before raising the fader or un-muting the channel. The PK! LED illuminates dimly to indicate the PFL switch is pressed, and brightly to indicate the channel signal is within 5dB of clipping.

Fader

The 100mm fader affects the level of the channel signal to the left & right buses and Auxes 3 & 4. There is 10dB of gain at the top and the unity gain position is marked by "0".

STEREO INPUT CHANNEL ST I

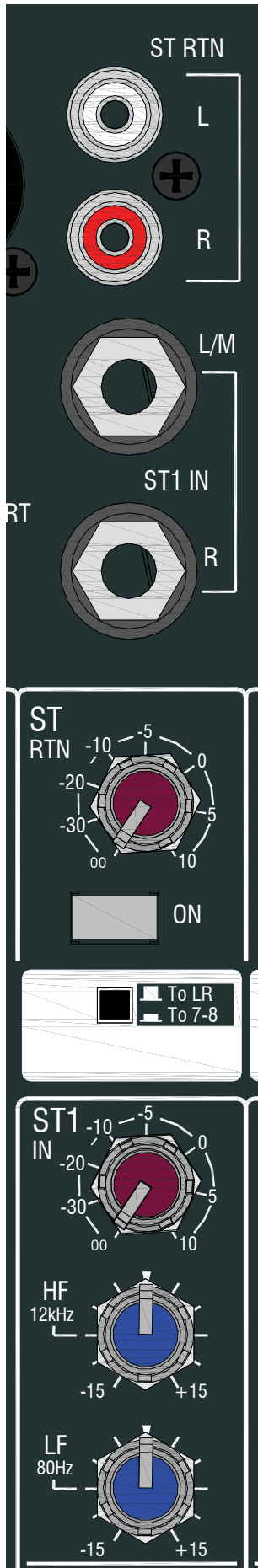

Stereo Return Phono sockets

This is an additional stereo input to the main stereo channel input (below). The gain is varied by the ST RTN control and this input can be sent to either the stereo channel or straight to the L R main bus, depending on the setting of the under-panel switch. These inputs are unbalanced.

Stereo I input jack sockets

Standard 1/4" jack sockets for line level stereo signals. Can be used with a mono input where the L/M input will also connect to the R input if nothing is plugged in to R. The Stereo I inputs accept unbalanced or balanced signals.

Stereo Return Level control

Adjusts the level of the stereo return input from off (fully attenuated) to maximum where it has 10dB of gain.

Stereo Return ON switch

This switches the signal on when pressed in. Leaving the switch in the up position is recommended when the stereo return input is not in use to minimise unwanted noise being passed through.

Stereo Routing selector switch

This switch selects whether the Stereo Return signal is sent to the L R bus directly, or the stereo channel I. When it is pressed in, the Stereo Return signal sums together with the main stereo input.

Stereo I Level control

Adjusts the level of the ST I input. The range is from off to +10dB.

Stereo Channel EQ

The Stereo Channel EQ is 2 band with corner frequencies of 12kHz for the HF and 80Hz for the LF.

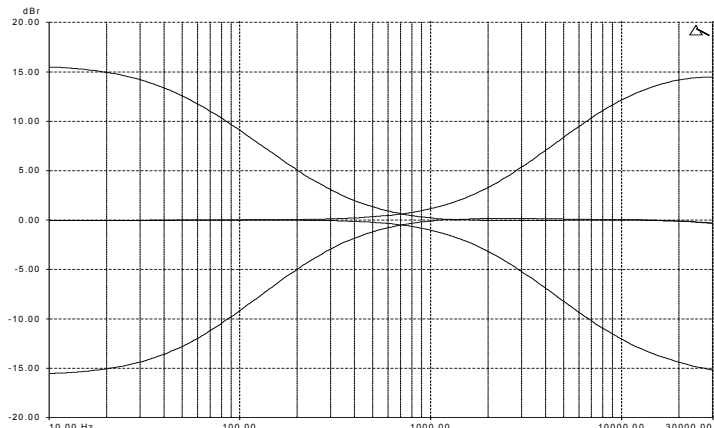

STEREO INPUT CHANNEL ST I

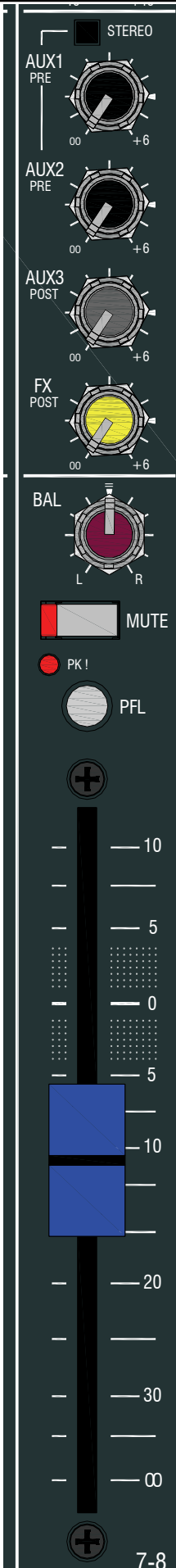

STEREO Aux 1 & 2 switch

This is an under-panel selector switch that configures Auxes 1 & 2 to be either mono sends or a stereo send pair.

UP: A mono sum of the left & right stereo channel signal is sent to Aux buses 1 & 2 by the control knobs.

DOWN: The left stereo channel signal is sent to Aux 1 and the right is sent to Aux 2 by the control knobs.

Note: This can be useful when setting up a separate stereo output from the main L R output using Auxes 1 & 2, possibly for recording. This can be selected to feed the USB output to create an independent stereo feed for recording using a computer.

Aux 1 & 2 sends

These control the level of the signals sent to the Aux 1 & 2 buses. The Aux 1 & 2 send controls are configured either as two mono sends or as a stereo pair depending on the position of the STEREO switch (please see above).

Auxes 1 & 2 are pre-fade, but muted when the Mute switch is pressed. There is 6dB of gain at the fully clockwise position.

Aux 3 & FX sends

These controls take a mono sum of the left & right stereo channel signals from after the fader and send them to the Aux 3 and FX buses respectively. They are muted when the Mute switch is pressed and have 6dB of gain at maximum.

Balance control

The Balance control varies the relative levels between the left and right channels.

Mute Switch

Mutes the signals to the main L R and the Aux buses.

PFL Switch & PK! LED

The Pre-Fade Listen switch takes a mono sum of the stereo channel signals from before the fader and mute switch. When pressed the signal will appear on the L R meters and be fed to the headphones circuit for monitoring.

The PK! LED illuminates dimly to indicate the PFL switch is pressed, and brightly to indicate the channel signal is within 5dB of clipping.

Fader

The 100mm fader affects the level of the channel signal to the left & right buses and Auxes 3 & FX. There is 10dB of gain at the top and the unity gain position is marked by "0".

STEREO INPUT CHANNELS ST2, 3 & FX

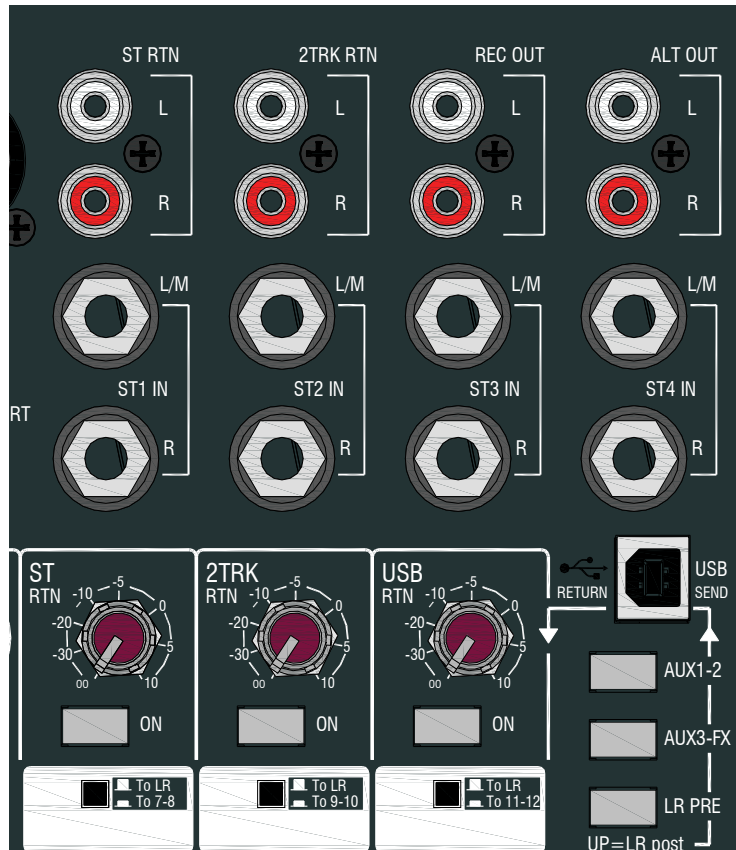

Stereo Input Channel ST1

This is stereo input channel ST1 as described on previous pages.

Stereo Input Channel ST2

The only difference from stereo input channel ST1 is the labelling of the additional stereo input on phono connectors, labelled as 2 Track Return. This is to indicate that a 2 track (stereo) input can be inserted here for playback of a stereo recording or incidental music.

Stereo Input Channel ST3

Stereo input channel ST3 also has an additional stereo input, but instead of being on phono connectors, it comes from the USB audio input. The level control, ON switch and routing switch are the same as for stereo input channel ST1. It is best to leave the ON switch in its UP position when the USB input is not in use. The phono sockets carry the analogue record output signals that are sourced from the main L R outputs. They are pre-fade, post L R insert.

Effects Channel and ST4 input.

The FX (Effects) channel has one stereo input (ST4) on jack sockets which adds to the output of the built in digital effects processor. This stereo input can be used with an external effects processor to return the effects signal to the main mix.

The phono sockets carry the Alternate stereo output which comes from the selector switches and level control in the master section.

USB connector & output selection.

A standard USB type B connector plugs in here (cable supplied). The three selector switches determine what is sent on the USB output. They work on a priority system, so that if more than one is pressed the one nearest the top takes precedence. So if all 3 are pressed, then the Aux 1 & 2 signals would be sent by the USB device. Please refer to the section describing using the USB audio port for more details.

EFFECTS PROCESSOR

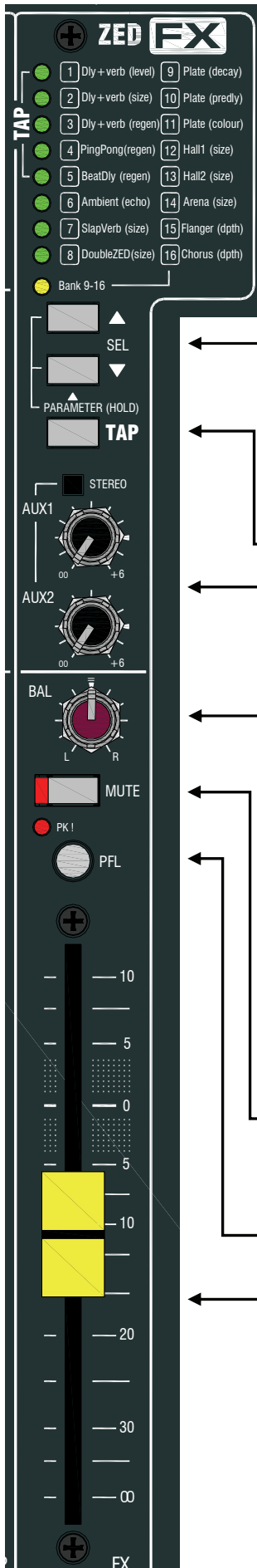

Effects Type Selection LED.

8 Green LED's show one of 16 effects types available. If the Bank LED is off the green LED's will show one of 1 to 8 on the effects list (or off if no LED's are lit), if the Bank LED is on the green LED's will show which of effects types 9 to 16 is selected. For effects types 1 to 5, the green LED will blink in time with the tempo of the delay time.

The green LED's also display the level of the parameter adjustment when the TAP button is held down. The more LED's that illuminate, the more the parameter is increased in value or intensity.

Bank LED.

The Bank LED illuminates when one of the effects type 9 to 16 is selected. If the Bank LED is on, then the green LED will show which effect is selected from the list.

SEL Buttons.

The SEL buttons select the type of effect. They also adjust the parameter of the selected effect when the TAP button is held down.

TAP Button.

The TAP button is used in two ways. If one of effects types 1 to 5 are selected then the TAP button can be used for adjusting the frequency or tempo of the delay parameter. If the TAP button is held down, the SEL buttons then become parameter adjust buttons to increase or decrease the level of the parameter assigned to the selected effect.

AUX 1 & 2 Send controls.

These controls send the effects processor output signal (and the external effects return on ST4) to the Aux buses 1 & 2, either in mono or stereo depending on the under-panel selector switch (described on Page 17).

These send controls are commonly used to add some reverb or effect onto the Aux 1 & 2 buses that may be used for stage monitoring or foldback.

The overall level from these send controls will be affected by the fader and the Mute switch, so the effect can be quickly cut from the monitors if required (for announcements etc).

Balance control.

The Balance control varies the relative levels between the left and right channels.

Mute Switch

Mutes the effect signals to the main L R and the Aux buses. The Footswitch jack socket can also be used to mute the effects signal.

PFL Switch & PK! LED

The Pre-Fade Listen switch takes a mono sum of the stereo effects signals from before the fader and mute switch. When pressed the signal will appear on the L R meters and be fed to the headphones circuit for monitoring.

The PK! LED illuminates dimly to indicate the PFL switch is pressed, and brightly to indicate the effects signal is within 5dB of clipping

Fader

The 100mm fader affects the level of the effects signal to the left & right buses and Auxes 1 & 2. There is 10dB of gain at the top and the unity gain position is marked by "0".

EFFECTS PROCESSOR

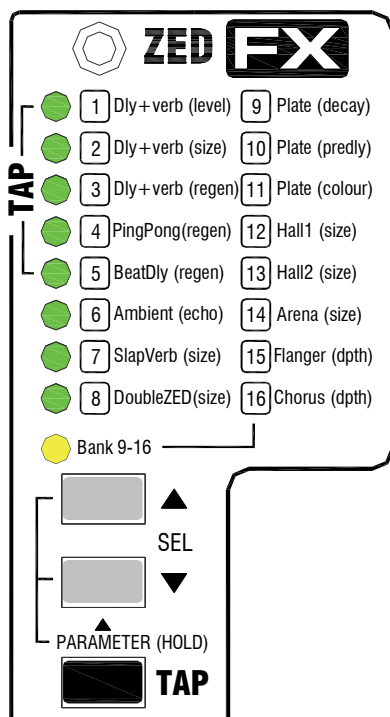

Effects Type List & Description.

There are 16 different effects presets in the ZED Effects Processor. Each is fed with a mono signal from the FX bus, and the output from the effects processor is in stereo.

Each preset has a parameter adjust control which is matched to the preset. This control may morph several parameters all at once, for example the parameter control for the Chorus effect will adjust not only the depth, but the response of the filters in software to create a more or less intense effect. In general, when adjusting the effect parameter, the more LED's that are illuminated, the more intense the effect or higher the parameter value.

To restore the parameter settings to the factory defaults, hold down both SEL buttons whilst switching on the power to your ZED.

Effects Type Table with description.

Effect	Preset Name	Effect Description & Parameter adjustment.
1	Dly+verb(level)	Delay with Reverb. Delay feeds reverb (Classic Plate). TAP for delay time Min = 70mS Max = 1.35S, Adjust the level of reverb.
2	Dly+verb(size)	Delay with Reverb. Delay feeds reverb (Classic Plate). TAP for delay time Min = Min = 70mS Max = 1.35S, PARAMETER Adjusts the size of reverb.
3	Dly+verb(regen)	Delay with Reverb. Delay feeds reverb (Classic Plate). TAP for delay time Min = 70mS Max = 1.35S, PARAMETER adjusts the regeneration of the delay.
4	PingPong(regen)	Ping Pong delay (left then right) in parallel with Plate reverb. TAP for left delay time Min = 70mS Max = 1.35S, PARAMETER adjusts the delay regeneration.
5	BeatDly(regen)	As (4) but right delay is set for 1/4 beat of left. Good for off beat 4/4 delay sound. TAP for left delay time & PARAMETER adjusts the delay regeneration.
6	Ambient(echo)	Echo Delay with Reverb. PARAMETER adjusts the echo time.
7	SlapVerb(size)	Reverb with echo reflections creating classic slapback reverb sound. PARAMETER adjusts the slapback size (more slap echo).
8	DoubleZED(size)	Classic stereo doubler. PARAMETER adjusts delay and size.
9	Plate(decay)	Classic plate reverb. PARAMETER adjusts decay time.
10	Plate(predly)	Plate reverb with pre-delay. Good for vocals/percussion. PARAMETER adjusts pre-delay time (for increased intelligibility).
11	Plate(colour)	Classic plate reverb. PARAMETER adjusts tonal texture from dark to bright.
12	Hall1(size)	Smooth classic hall reverb. PARAMETER adjusts size of hall.
13	Hall2(size)	Brighter hall reverb. PARAMETER adjusts size of hall.
14	Arena(size)	Arena reverb. PARAMETER adjusts size of arena.
15	Flanger(dpth)	Classic flanger effect. PARAMETER adjusts depth and tonality.
16	Chorus(dpth)	Chorus effect. PARAMETER adjusts depth and tonality.

MASTER SECTION

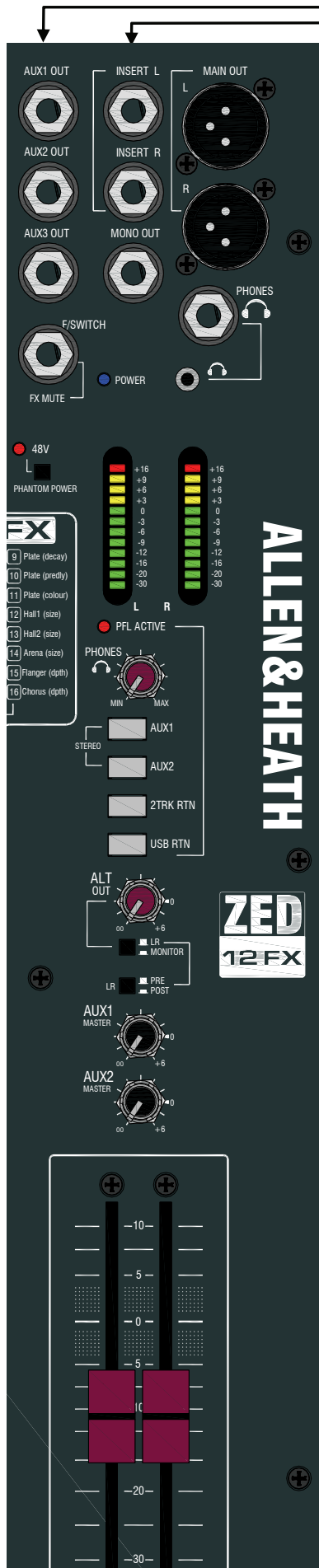

Aux output jack sockets

Standard 1/4" jack sockets for Aux 1 to 3 outputs (FX or Aux 4 is the internal Effects bus and does not have an output socket). Impedance balanced, nominal level = 0dBu.

Mix L R Insert jack sockets

Standard 1/4" (6.25mm) Jack sockets for unbalanced insert send and return signals. Wired Tip = send, Ring = return, Sleeve = Chassis. Nominal level is 0dBu.

Main L R output xlr sockets

Main left & right outputs. Impedance balanced signals, pin 1 = chassis, pin 2 = hot (+), pin 3 = cold (-). Nominal level = 0dBu.

Mono output jack socket

A mono sum of the main left & right post-fade signals.

Headphones jack sockets

One 1/4" and one 3.5mm jack socket for stereo headphones. Wired Tip = left, Ring = right, Sleeve = Chassis. It is recommended that headphones with an impedance higher than 30ohms are used.

Footswitch connection

Standard 1/4" (6.25mm) Jack socket for use with a footswitch. Wired so that a switch closure between Tip and Sleeve will activate the effects mute circuitry to cut the effects return (and ST4) from the main LR mix and the Aux 1 & 2 sends.

48v Phantom Power switch

Press this in to switch 48v Phantom Power to all the Mic input xlr connectors, if any of the microphones attached require power. Dynamic microphones won't mind being connected to a phantom powered input, but care is needed to ensure that 48v is not switched on if an xlr is used to input a signal from an electronic circuit (ie. Another mixer or keyboard).

When switching 48v on or off, or plugging in connectors to channels with 48v present, it is important (and normal practise) to mute the channels. This will avoid loud clicks and bangs potentially getting through to the amps & speakers with the possible effect of damaging the speakers, or the audience's hearing!

Left Right meters

12 segment LED meters, peak type response, the "0" position reflects 0dBu at the outputs. These display the signals from the monitor selector switches below, or the PFL (pre-fade listen) signals from any selected channels, which overrides.



MASTER SECTION

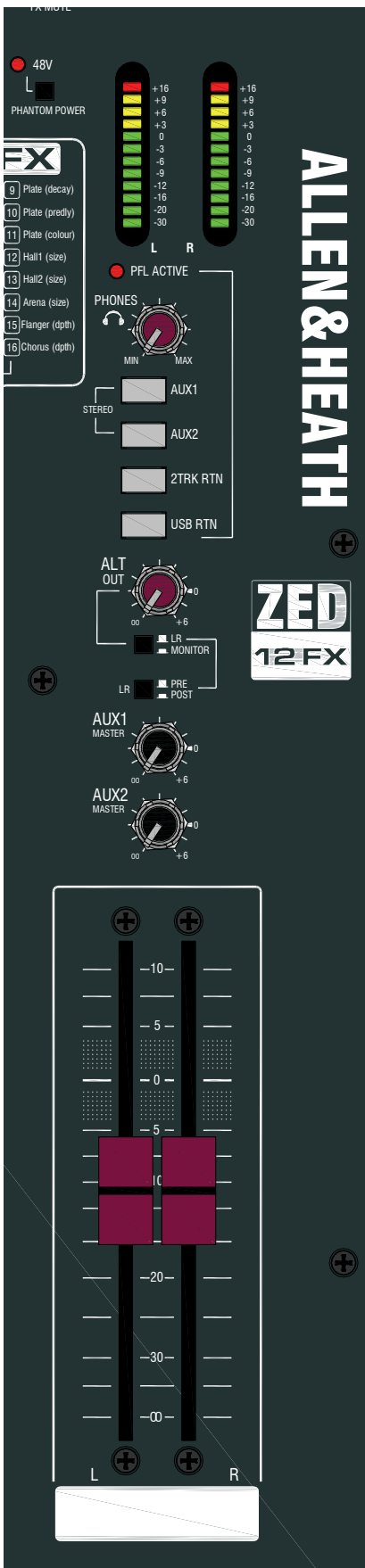

Headphone level control

Adjusts the level of the headphone signal.

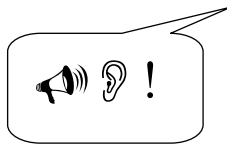

Warning ! To avoid damage to your hearing do not operate the headphones or sound system at excessively high volume. Continued exposure to high volume sound can cause frequency selective or wide range hearing loss.

Monitor selector switches

These 4 switches select the signal source for the headphones monitor and the meters. They work on a priority basis. If they are all up then the post-fade main L R signals will feed the monitor circuit, if USB and 2 TRK are pressed, then only the 2 TRK signals will feed the monitor circuit. The stereo option of pressing both AUX 1 and AUX 2 together allows Aux 1 to feed the left and Aux 2 to feed the right monitor circuit. This is useful if a stereo mix is set up using Auxes 1 & 2.

Alternate output level control

The Alt (Alternate) Output is useful for connecting a pair of monitor speakers separate to the main outputs. The level control adjusts the volume of the output from off to +6dB.

Alternate output selector switches

These under-panel switches select the signal source for the Alt output. They select between the L R pre-fade, L R post-fade or the monitor L R signals.

Aux 1 & 2 master level controls

For adjusting the level of the Aux 1 and 2 outputs. The range of level control is from off to +6dB.

Master L R faders

High quality 100mm faders for the main L R outputs. 10dB gain at the top, unity gain marked at "0".

USB CONNECTION

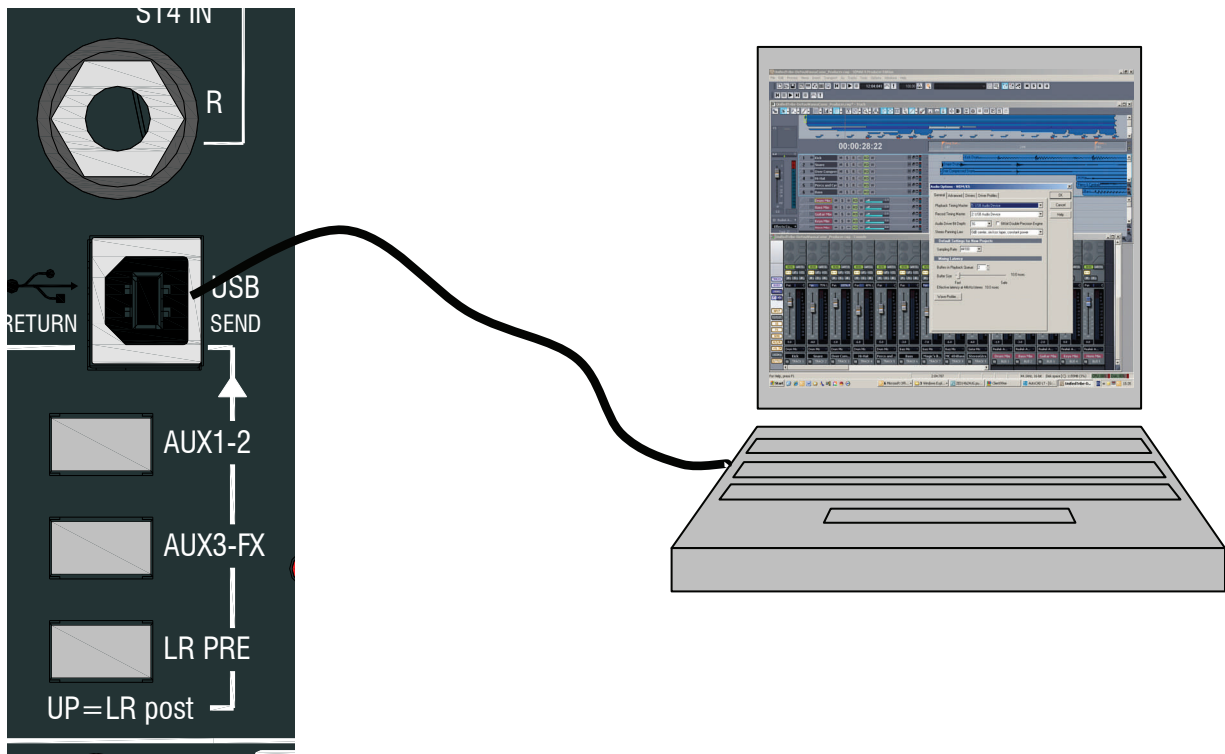

USB Audio Interface

The ZED is equipped with a stereo bi-directional USB 1.1 compliant audio CODEC. It is fully compliant with USB 2 ports and uses standard Windows and MAC Core Audio Drivers. In other words, plug it in and your computer will find it and be able to transfer audio to and from the ZED USB device.

You will need some form of audio software running on your computer to be able to record and play back what you record, but on a basic level, you can use your computers media player to play straight to the ZED device.

Just a couple of points to look out for:

Windows XP/Vista: When you plug in your ZED USB interface to your computer, if the volume level is low or inaudible, check the device volume in control panel/Sounds and Audio Devices/Volume. Set the volume to High.

Windows 7: At present, Windows 7 treats the USB audio device as a microphone source instead of a line input, so set the device volume level much lower, we found setting to 3 is ideal.

If you want to reduce latency (delay) there are some different drivers available for your operating system. Please check the Allen & Heath website www.allen-heath.com for details and links to third party companies able to supply appropriate drivers for your operating system.



cakewalk **SONAR X1 LE**

DIGITAL AUDIO WORKSTATION

SONAR X1 LE Overview.

SONAR X1 LE is a software application from Cakewalk and is included free of charge with your new ZED mixing console.

SONAR X1 LE is a powerful first step into the world of sequencing and hard disk recording on the Windows platform. You'll be able to record from your ZED mixer, create tracks and arrange songs, then play back to your ZED mixer via the USB port. You can decide whether the SONAR family of products is right for you. If you choose to upgrade your copy of SONAR X1 LE to a more full-featured version, like SONAR X1 Producer, you'll now be able to do so at significant savings.

We will describe the basic steps of installing the software and getting started here, for more comprehensive help or technical support please use the Help files in SONAR X1 LE or visit the SONAR LE website:

www.cakewalk.com/Products/SONARLE/

The website will have details on registering your product and upgrading it should you wish. There are also tutorials to get you started.

SONAR X1 LE Key Features.

- Powered by SONAR X1
- 32 audio tracks
- 64 MIDI tracks
- 8 simultaneous inputs and outputs
- 24-bit/96 kHz audio quality
- 24 simultaneous effects
- 8 simultaneous virtual instruments
- Integrated VST/VSTi support
- Support for ACID™-format loops
- Support for ReWire clients such as Live or Reason
- Active Controller Technology™ automatically maps MIDI keyboards and control surfaces to the parameters you need most on effects, instruments, volume, pan, and other mix elements
- Edit MIDI directly from the Track View with the Inline Piano Roll View.
- Support for 32-bit and 64-bit versions of Windows 7, Windows Vista, and Windows XP operating systems

SONAR LE Installation.

Put disk into CD or DVD ROM drive and follow instructions on screen.

Register your copy of SONAR LE by accessing the Cakewalk website. Your SONAR LE software will display its unique serial number. If the installing computer has access to the internet just click "Register", if not, use a different computer to access cakewalk.com and register by typing in the serial number.

SONAR LE will run automatically after installation, or else click the icon created on the desktop.

To initially configure SONAR XI LE with ZED:

Create a normal Cakewalk project (an option offered when starting SONAR).

In Edit/Preferences configure the I/O—enable the USB Audio CODEC under Devices. This is the ZED interface. For now, disable any other devices listed, for example the computer’s internal soundcard listed here.

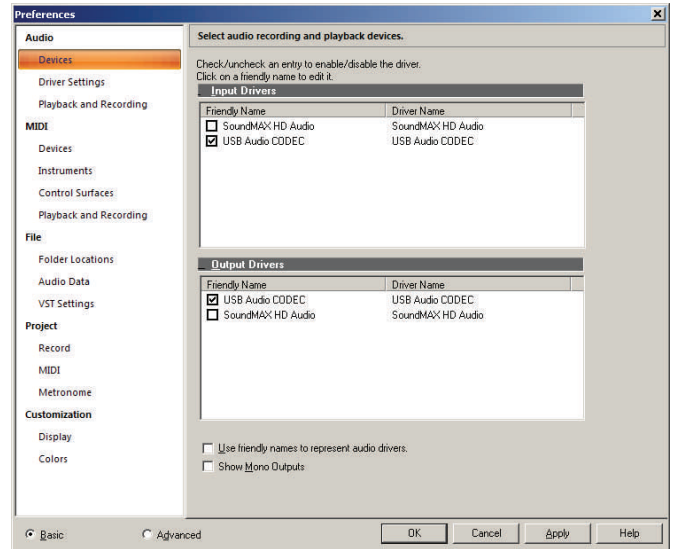

In SONAR XI LE different views are available. The Track view shows audio and MIDI tracks in a timeline aspect and the Console view shows a mixer style layout. Different views can be displayed by the “dock” tabs at the bottom of the screen. On the left is the Track Inspector.

Add an audio track or two clicking Insert/Audio Track. Tracks can be named by clicking the name box, here we have named tracks I&2 ZED-Left and ZED Right.

Configure the inputs for the tracks using the IN/OUT routing drop-down menu in the Track Inspector. Here we select LEFT USB Audio to track 1 and RIGHT USB Audio to track 2. The track outputs are routed to the Master bus in SONAR.

Select the output for the Master bus in SONAR by clicking the drop-down arrow in the Inspector and selecting STEREO USB Audio CODEC which is the ZED USB return.

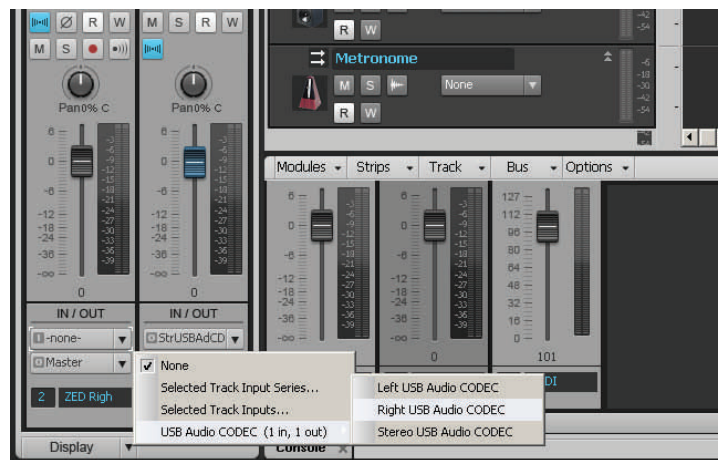

In order to check the configuration, enable Input Echo On (the top right button in the track view header). Play some audio through your ZED mixer and select the USB send buttons to the audio signal (for example the L-R mix).

N.B. Do not route the USB return to the L-R mix in your ZED mixer at this stage—a feedback loop could occur. You should see the signal on the metering in SONAR LE. To try a recording, enable the Record buttons on the tracks and click the main Record button on the transport toolbar. Recorded audio signal should be displayed in red. Click stop, or hit the space bar on your keyboard to stop the recording.

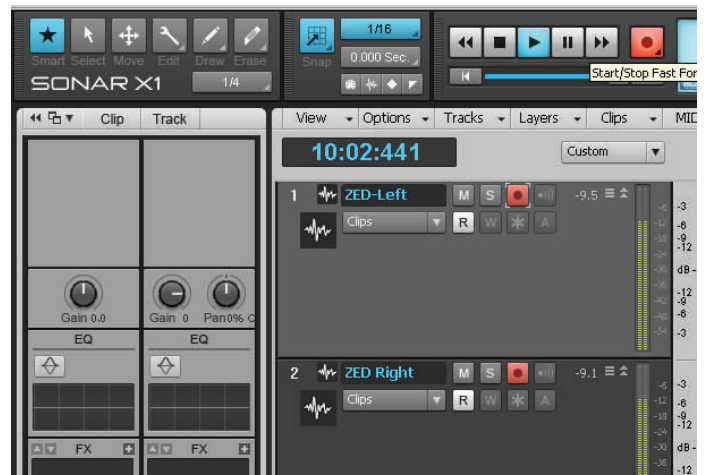

Once you have recorded audio in your SONAR project you can play it back to the ZED mixer.

De-select the record arm buttons and Input Echo on the tracks (or you could get both the recorded track signal AND the live input signal playing, and possibly a feedback loop).

Press play or hit the spacebar on the keyboard. You should see the audio being played and levels on the meters in SONAR.

On your ZED mixer, Press USB Rtn ON and turn the level up to the desired point. Audio should be playing from the tracks in SONAR to the L-R bus in your ZED.



CONNECTING A ZED TO PRO TOOLS 9 ON A MAC

If you use Pro Tools 9 and want to connect to your ZED console using a Mac computer, here are some notes:

1. Connect your ZED mixer to your Mac via USB and power on the mixer.
2. With Pro Tools 9 installed, open Audio MIDI Setup on your Mac. PT9 should have created a Pro Tools Aggregate I/O folder in the Audio Devices list. The ZED interface should appear as USB Audio CODEC in the list along with other audio devices in your system. Tick Use to enable the device in PT9. You may need to also tick Resample in order for the audio data settings to be compatible with your PT9 session.



Audio MIDI Setup...

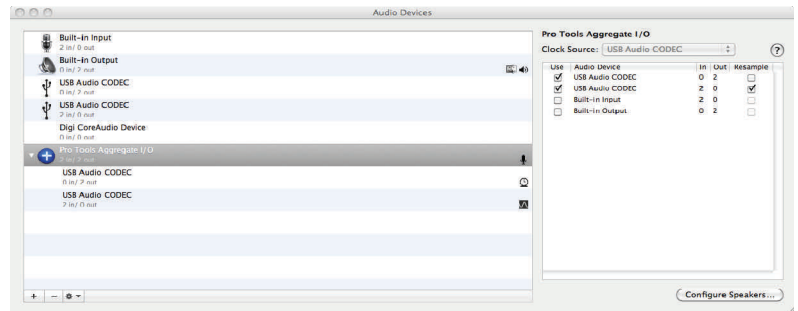

3. Run Pro Tools 9 and create a new session with at least two audio tracks. Open the SETUP/ Playback Engine window and select Pro Tools Aggregate I/O as the Current Engine. Click OK.

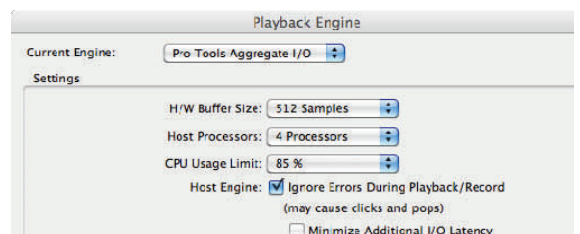

4. In PT9 click SETUP and then I/O. Select Output from the menu and the devices available should appear in a box labelled PTAI/O (Pro Tools Aggregate I/O). Here you can create a new output path if one doesn't exist, name it (here it's called ZED Stereo OUT) and tick it to enable. The output path can be set as stereo or mono channels as is required.

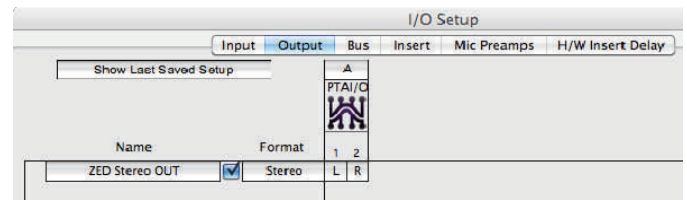

5. Still in I/O Setup, click the Input tab. Again the input sources should appear for enabled devices in Pro Tools Aggregate I/O. Create a new path for the inputs and name as you prefer. Here we have a stereo input named ZED-Stereo Input. Note that mono channels can use one channel of a stereo input path. Make sure the path is ticked and click OK.

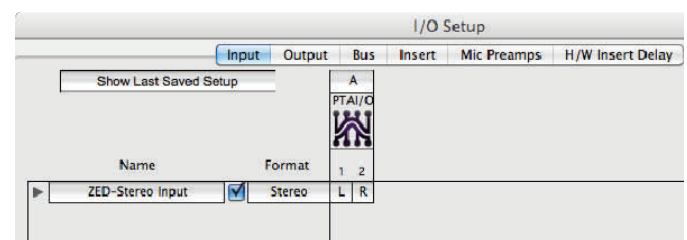

6. Select the inputs and outputs for your tracks in your session. Here the input for mono Track 1 is selected as the Left channel from the ZED USB interface. The track outputs can either be routed to the ZED directly or to a master bus in Pro Tools and then to the ZED.

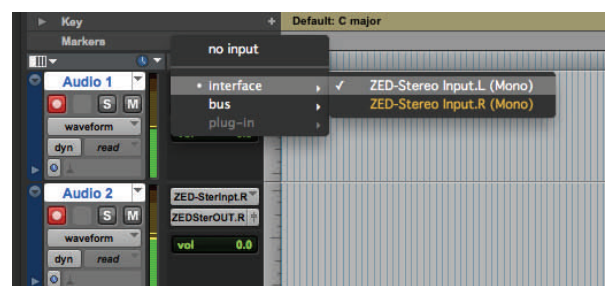

7. Finally check the interface and settings are working by recording some audio from the ZED mixer to PT9 and then play the audio back to the ZED afterwards. Always be wary of audio feedback loops with bi-directional interface connections which can cause high level audio feedback if signals are routed back to themselves either in the mixer or in the software system.

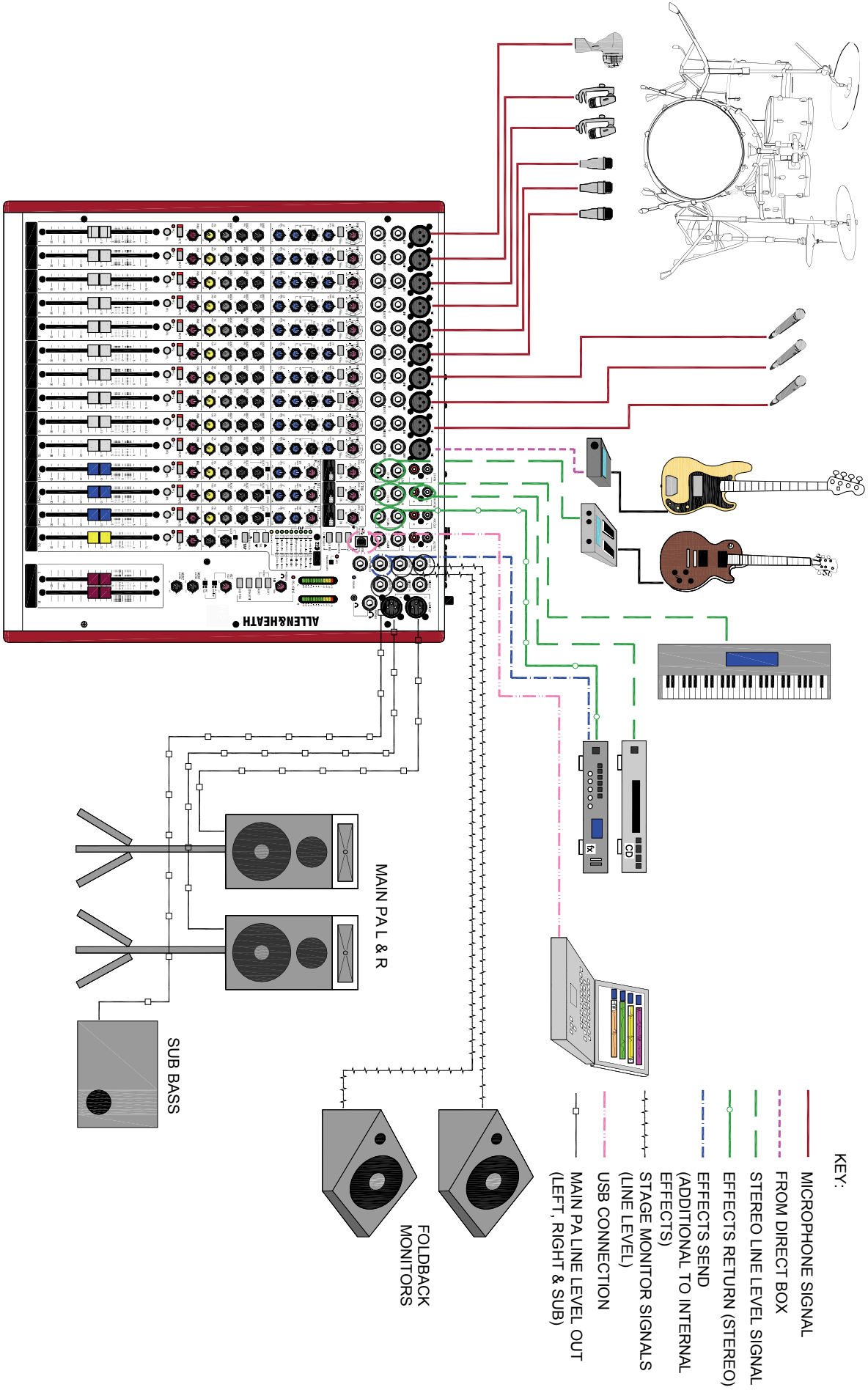

APPLICATION DRAWING: STUDIO SETUP

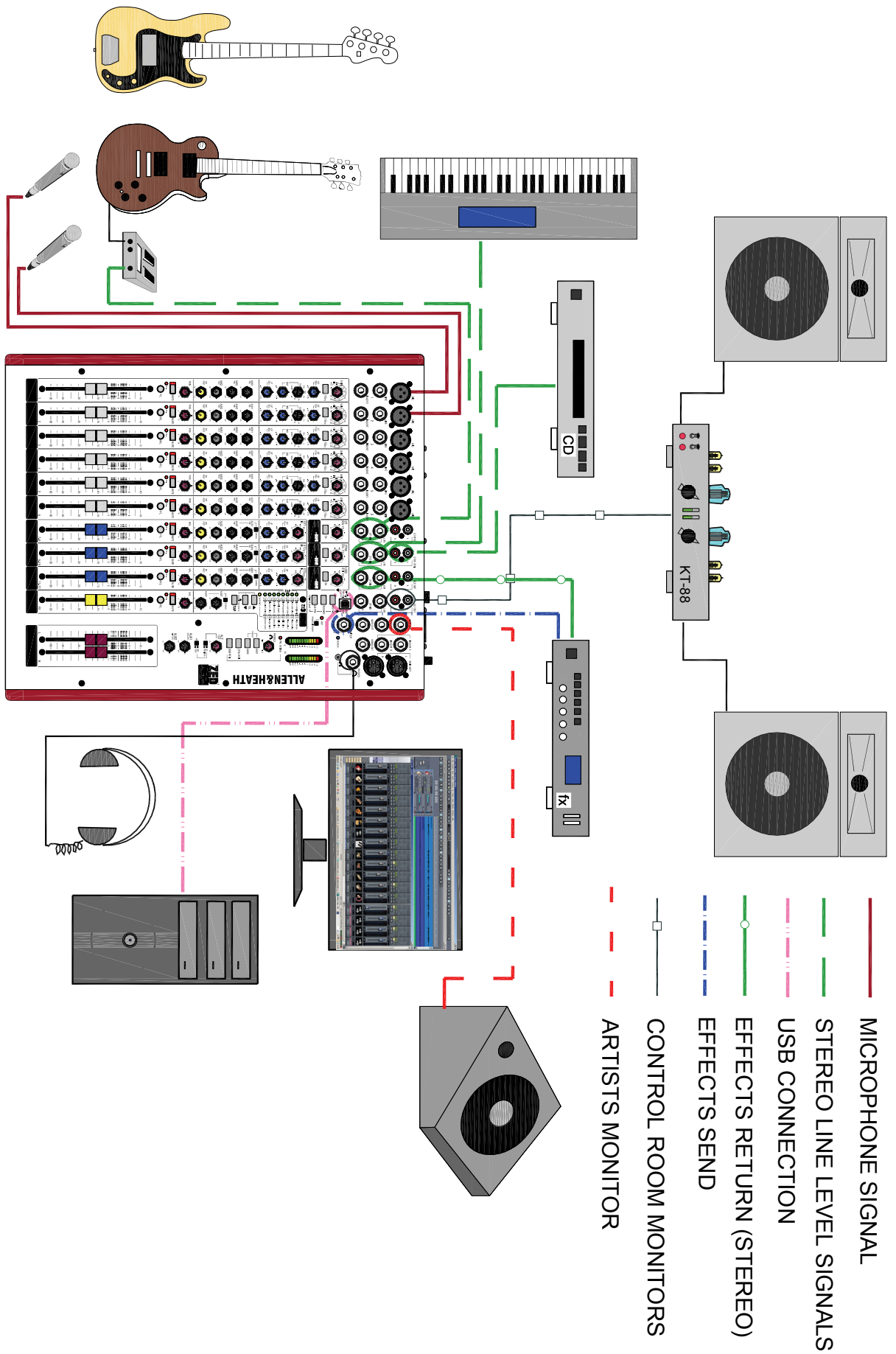

WIRING NOTES

Insert cable wiring

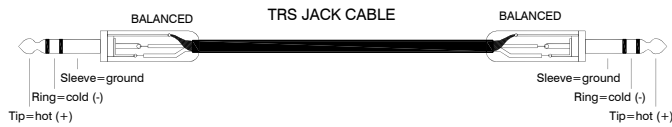
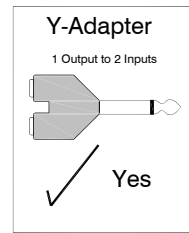
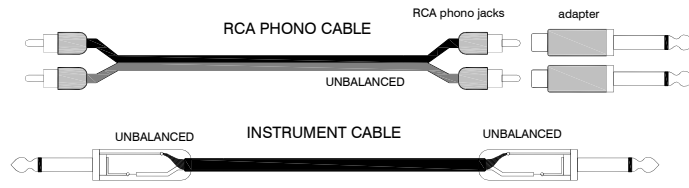
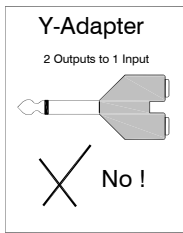
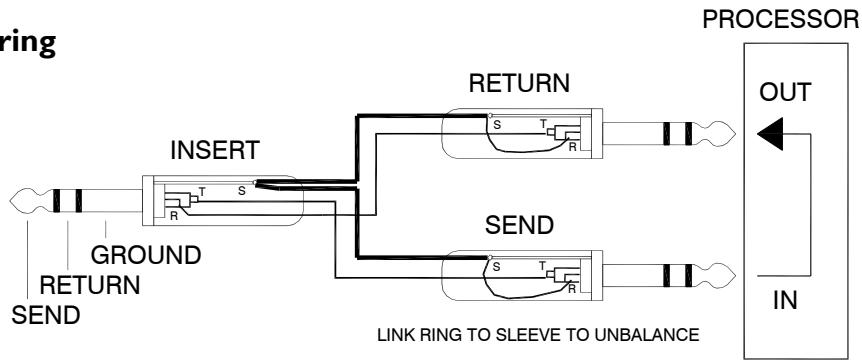

TO INPUT

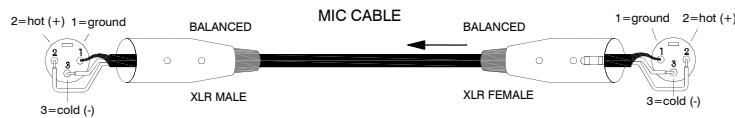

FROM OUTPUT

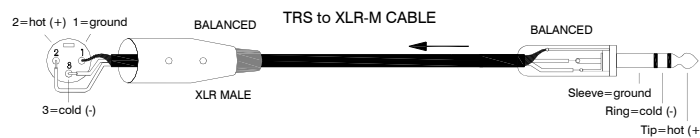
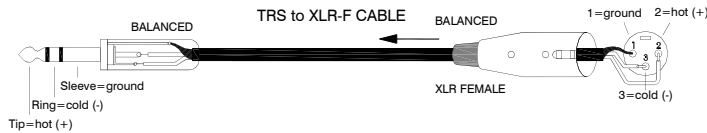

General Wiring Information

PRODUCT SUPPORT

Investigate ALLEN & HEATH's other ranges at www.allen-heath.com

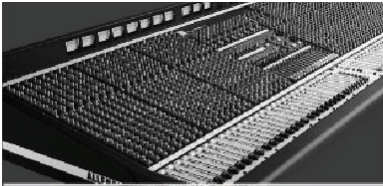

Large Live Sound mixers — iLive digital, and GL Series

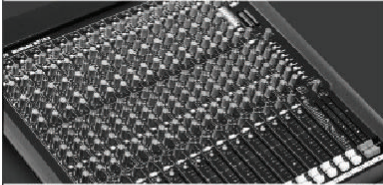

Small Format Live Sound mixers — ZED, MixWizards and PA Series



DJ products — Xone Series



Sound Management Series — iDR Series

Registering your product

Thank you for buying the Allen & Heath ZED-12FX, 16FX or 22FX mixer. We hope that you are happy with it and that you enjoy many years of faithful service with it.

Please go to www.allen-heath.com/register.asp and register your product's serial number and your details. By registering with us and becoming an official Registered User, you will ensure that any warranty claim you might make is actioned quickly and with the minimum delay.

Alternatively, you may either copy or cut off this section of the page, fill in the details, and return it by mail to:

Allen & Heath Ltd, Kernick Industrial Estate, Penryn, Cornwall TR10 9LU, UK



ALLEN & HEATH PRODUCT REGISTRATION

Thank you for buying an Allen & Heath product. We hope that you're happy with it and that you enjoy many years of faithful service with it.

SERIAL NUMBER

Please return this section of the card by mail and retain the other part for your records. You can also register online at www.allen-heath.com. Thanks for your help.

Your Name: _____

Company Name: _____

Address 1: _____

Address 2: _____

Town/City: _____ County/State: _____

Country: _____ Postcode/Zip: _____

Telephone: _____

Email: _____

Why did you choose this console? _____

Which other products did you consider before choosing A&H? _____

Is there any thing you would like to improve on this mixer? _____

What audio magazines do you read? _____

If you were going to design a mixer for your work, what are the 6 most important features it should have (in order of importance)

1	2
3	4
5	6

We may use the information you provide to inform you of future product developments. We will not give or sell this data to third parties. Please indicate with an 'x' if you do not wish to receive any further communications from us.

NOTES

NOTES

