

Monitor 8™

User Guide



MOTU

1280 Massachusetts Avenue
Cambridge, MA 02138
Business voice: (617) 576-2760
Business fax: (617) 576-3609
Web site: www.motu.com
Tech support: www.motu.com/support

SAFETY PRECAUTIONS AND ELECTRICAL REQUIREMENTS FOR THE MONITOR 8 and MOTU AVB SWITCH ("PRODUCT")

 **CAUTION! READ THIS SAFETY GUIDE BEFORE YOU BEGIN INSTALLATION OR OPERATION. FAILURE TO COMPLY WITH SAFETY INSTRUCTIONS COULD RESULT IN BODILY INJURY OR EQUIPMENT DAMAGE.**

 **HAZARDOUS VOLLAGES: CONTACT MAY CAUSE ELECTRIC SHOCK OR BURN. TURN OFF UNIT BEFORE SERVICING.**

WARNING: TO REDUCE THE RISK OF FIRE OR ELECTRICAL SHOCK, DO NOT EXPOSE THIS APPLIANCE TO RAIN OR OTHER MOISTURE.

CAUTION: TO REDUCE THE RISK OF ELECTRICAL SHOCK, DO NOT REMOVE COVER. NO USER-SERVICEABLE PARTS INSIDE. REFER SERVICING TO QUALIFIED SERVICE PERSONNEL.

WARNING: DO NOT PERMIT FINGERS TO TOUCH THE TERMINALS OF PLUGS WHEN INSTALLING OR REMOVING THE PLUG TO OR FROM THE OUTLET.

WARNING: IF NOT PROPERLY GROUNDED THE MOTU PRODUCT COULD CAUSE AN ELECTRICAL SHOCK.

The MOTU product is equipped with a three-conductor cord and grounding type plug which has a grounding prong, approved by Underwriters' Laboratories and the Canadian Standards Association. This plug requires a mating three-conductor grounded type outlet as shown in Figure A below. If the outlet you are planning to use for the MOTU product is of the two prong type, DO NOT REMOVE OR ALTER THE GROUNDING PRONG IN ANY MANNER. Use an adapter as shown below and always connect the grounding lug to a known ground. It is recommended that you have a qualified electrician replace the TWO prong outlet with a properly grounded THREE prong outlet. An adapter as illustrated below in Figure B is available for connecting plugs to two-prong receptacles.

Figure A

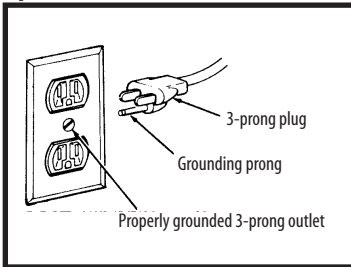
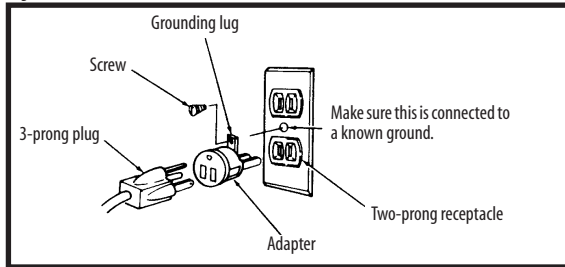

Figure B



WARNING: THE GREEN GROUNDING LUG EXTENDING FROM THE ADAPTER MUST BE CONNECTED TO A PERMANENT GROUND SUCH AS TO A PROPERLY GROUNDED OUTLET BOX. NOT ALL OUTLET BOXES ARE PROPERLY GROUNDED.

If you are not sure that your outlet box is properly grounded, have it checked by a qualified electrician. NOTE: The adapter illustrated is for use only if you already have a properly grounded two-prong receptacle. Adapter is not allowed in Canada by the Canadian Electrical Code. Use only three wire extension cords which have three-prong grounding type plugs and three-prong receptacles which will accept the MOTU product plug.

IMPORTANT SAFEGUARDS

1. Read these instructions. All the safety and operating instructions should be read before operating the product.
2. Keep these instructions. These safety instructions and the product owner's manual should be retained for future reference.
3. Heed all warnings. All warnings on the product and in the owner's manual should be adhered to.
4. Follow all instructions. All operating and use instructions should be followed.
5. Do not use the product near water.
6. Cleaning - Unplug the product from the computer and clean only with a dry cloth. Do not use liquid or aerosol cleaners.
7. Ventilation - Do not block any ventilation openings. Install in accordance with the manufacturer's instructions.
8. Heat - Do not install the product near any heat sources such as radiators, heat registers, stoves, or another apparatus (including an amplifier) that produces heat.
9. Overloading - Do not overload wall outlets and extension cords as this can result in a risk of fire or electrical shock.
10. Grounding - Do not defeat the safety purpose of the polarized or grounding-type plug. A polarized plug has two blades with one wider than the other. A grounding-type plug has two blades and a third grounding prong. The wide blade or the third prong are provided for your safety. If the provided plug does not fit into your outlet, consult an electrician for replacement of the obsolete outlet.
11. Power cord - Protect the product power cord from being walked on or pinched by items placed upon or against them. Pay particular attention to cords and plugs, convenience receptacles, and the point where they exit from the unit.
12. Power switch - Install the product so that the power switch can be accessed and operated at all times.
13. Disconnect - The main plug is considered to be the disconnect device for the product and shall remain readily operable.
14. Accessories - Only use attachments/accessories specified by the manufacturer.
15. Placement - Use only with the cart, stand, tripod, bracket or table specified by the manufacturer, or sold with the product. When a cart is used, use caution when moving the cart/apparatus combination to avoid injury from tip-over.
16. Surge protection - Unplug the product during lightning storms or when unused for long periods of time.
17. Servicing - Refer all servicing to qualified service personnel. Servicing is required when the product has been damaged in any way, such as when a power-supply cord or plug is damaged, liquid has been spilled or objects have fallen into the product, the product has been exposed to rain or moisture, does not operate normally, or has been dropped.
18. Power Sources - Refer to the manufacturer's operating instructions for power requirements. Be advised that different operating voltages may require the use of a different line cord and/or attachment plug.
19. Installation - Do not install the product in an unventilated rack, or directly above heat-producing equipment such as power amplifiers. Observe the maximum ambient operating temperature listed below.
20. Power amplifiers - Never attach audio power amplifier outputs directly to any of the unit's connectors.
21. Replacement Parts - When replacement parts are required, be sure the service technician has used replacement parts specified by the manufacturer or have the same characteristics as the original part. Unauthorized substitutions may result in fire, electric shock or other hazards.
22. Safety Check - Upon completion of any service or repairs to this MOTU product, ask the service technician to perform safety checks to determine that the product is in safe operating conditions.

ENVIRONMENT, HEAT AND VENTILATION

Operating Temperature: 10°C to 40°C (50°F to 104°F). The product should be situated away from heat sources or other equipment that produces heat. When installing the product in a rack or any other location, be sure there is adequate space around the product to ensure proper ventilation. Improper ventilation will cause overheating and can damage the unit.

TO REDUCE THE RISK OF ELECTRICAL SHOCK OR FIRE

Do not handle the power cord with wet hands. Do not pull on the power cord when disconnecting it from an AC wall outlet. Grasp it by the plug. Do not expose this apparatus to rain or moisture. Do not place objects containing liquids on it.

AC INPUT

100 - 240VAC ~ 50 / 60Hz • 0.5A max



Contents

Part 1: Getting Started

- 7 **Quick Start Guide**
- 9 **Monitor 8 Front Panel**
- 10 **Monitor 8 Rear Panel**
- 11 **MOTU AVB Switch**
- 13 **MOTU AVB Control Web App**
- 23 **About the Monitor 8**
- 27 **Packing List and System Requirements**
- 29 **Software Installation**
- 31 **Hardware Installation**

Part 2: Using your MOTU interface

- 43 **Presets**
- 47 **The Front Panel LCD**
- 49 **Working with Host Audio Software**
- 57 **Mixer Effects**
- 63 **Networking**

Part 3: Appendices

- 71 **Troubleshooting**
- 73 **Audio Specifications**
- 75 **Mixer Schematics**
- 79 **Updating Firmware**
- 81 **OSC Support**

About the Mark of the Unicorn License Agreement and Limited Warranty on Software

TO PERSONS WHO PURCHASE OR USE THIS PRODUCT: carefully read all the terms and conditions of the "click-wrap" license agreement presented to you when you install the software. Using the software or this documentation indicates your acceptance of the terms and conditions of that license agreement.

Mark of the Unicorn, Inc. ("MOTU") owns both this program and its documentation. Both the program and the documentation are protected under applicable copyright, trademark, and trade-secret laws. Your right to use the program and the documentation are limited to the terms and conditions described in the license agreement.

Reminder of the terms of your license

This summary is not your license agreement, just a reminder of its terms. The actual license can be read and printed by running the installation program for the software. That license agreement is a contract, and clicking "Accept" binds you and MOTU to all its terms and conditions. In the event anything contained in this summary is incomplete or in conflict with the actual click-wrap license agreement, the terms of the click-wrap agreement prevail.

YOU MAY: (a) use the enclosed program on a single computer; (b) physically transfer the program from one computer to another provided that the program is used on only one computer at a time and that you remove any copies of the program from the computer from which the program is being transferred; (c) make copies of the program solely for backup purposes. You must reproduce and include the copyright notice on a label on any backup copy.

YOU MAY NOT: (a) distribute copies of the program or the documentation to others; (b) rent, lease or grant sublicenses or other rights to the program; (c) provide use of the program in a computer service business, network, time-sharing, multiple CPU or multiple user arrangement without the prior written consent of MOTU; (d) translate, adapt, reverse engineer, decompile, disassemble, or otherwise alter the program or related documentation without the prior written consent of MOTU.

MOTU warrants to the original licensee that the disk(s) on which the program is recorded be free from defects in materials and workmanship under normal use for a period of ninety (90) days from the date of purchase as evidenced by a copy of your receipt. If failure of the disk has resulted from accident, abuse or misapplication of the product, then MOTU shall have no responsibility to replace the disk(s) under this Limited Warranty.

THIS LIMITED WARRANTY AND RIGHT OF REPLACEMENT IS IN LIEU OF, AND YOU HEREBY WAIVE, ANY AND ALL OTHER WARRANTIES, BOTH EXPRESS AND IMPLIED, INCLUDING BUT NOT LIMITED TO WARRANTIES OF MERCHANTABILITY AND FITNESS FOR A PARTICULAR PURPOSE. THE LIABILITY OF MOTU PURSUANT TO THIS LIMITED WARRANTY SHALL BE LIMITED TO THE REPLACEMENT OF THE DEFECTIVE DISK(S), AND IN NO EVENT SHALL MOTU OR ITS SUPPLIERS, LICENSORS, OR AFFILIATES BE LIABLE FOR INCIDENTAL OR CONSEQUENTIAL DAMAGES, INCLUDING BUT NOT LIMITED TO LOSS OF USE, LOSS OF PROFITS, LOSS OF DATA OR DATA BEING RENDERED INACCURATE, OR LOSSES SUSTAINED BY THIRD PARTIES EVEN IF MOTU HAS BEEN ADVISED OF THE POSSIBILITY OF SUCH DAMAGES. THIS WARRANTY GIVES YOU SPECIFIC LEGAL RIGHTS WHICH MAY VARY FROM STATE TO STATE. SOME STATES DO NOT ALLOW THE LIMITATION OR EXCLUSION OF LIABILITY FOR CONSEQUENTIAL DAMAGES, SO THE ABOVE LIMITATION MAY NOT APPLY TO YOU.

Update Policy

In order to be eligible to obtain updates of the program, you must complete and return the attached Mark of the Unicorn Purchaser Registration Card to MOTU.

Copyright Notice

Copyright © 2014 by Mark of the Unicorn, Inc. All rights reserved. No part of this publication may be reproduced, transmitted, transcribed, stored in a retrieval system, or translated into any human or computer language, in any form or by any means whatsoever, without express written permission of Mark of the Unicorn, Inc., 1280 Massachusetts Avenue, Cambridge, MA, 02138, U.S.A.

Limited Warranty on Hardware

Mark of the Unicorn, Inc. and S&S Research ("MOTU/S&S") warrant this equipment against defects in materials and workmanship for a period of TWO (2) YEARS from the date of original retail purchase. This warranty applies only to hardware products; MOTU software is licensed and warranted pursuant to separate written statements.

If you discover a defect, first write or call Mark of the Unicorn at (617) 576-2760 to obtain a Return Merchandise Authorization Number. No service will be performed on any product returned without prior authorization. MOTU will, at its option, repair or replace the product at no charge to you, provided you return it during the warranty period, with transportation charges prepaid, to Mark of the Unicorn, Inc., 1280 Massachusetts Avenue, MA 02138. You must use the product's original packing material for in shipment, and insure the shipment for the value of the product. Please include your name, address, telephone number, a description of the problem, and the original, dated bill of sale with the returned unit and print the Return Merchandise Authorization Number on the outside of the box below the shipping address.

This warranty does not apply if the equipment has been damaged by accident, abuse, misuse, or misapplication; has been modified without the written permission of MOTU, or if the product serial number has been removed or defaced.

ALL IMPLIED WARRANTIES, INCLUDING IMPLIED WARRANTIES OF MERCHANTABILITY AND FITNESS FOR A PARTICULAR PURPOSE, ARE LIMITED IN DURATION TO TWO (2) YEARS FROM THE DATE OF THE ORIGINAL RETAIL PURCHASE OF THIS PRODUCT.

THE WARRANTY AND REMEDIES SET FORTH ABOVE ARE EXCLUSIVE AND IN LIEU OF ALL OTHERS, ORAL OR WRITTEN, EXPRESS OR IMPLIED. No MOTU/S&S dealer, agent, or employee is authorized to make any modification, extension, or addition to this warranty.

MOTU/S&S ARE NOT RESPONSIBLE FOR SPECIAL, INCIDENTAL, OR CONSEQUENTIAL DAMAGES RESULTING FROM ANY BREACH OF WARRANTY, OR UNDER ANY LEGAL THEORY, INCLUDING LOST PROFITS, DOWNTIME, GOODWILL, DAMAGE OR REPLACEMENT OF EQUIPMENT AND PROPERTY AND COST OF RECOVERING REPROGRAMMING, OR REPRODUCING ANY PROGRAM OR DATA STORED IN OR USED WITH MOTU/S&S PRODUCTS.

Some states do not allow the exclusion or limitation of implied warranties or liability for incidental or consequential damages, so the above limitation or exclusion may not apply to you. This warranty gives you specific legal rights, and you may have other rights which vary from state to state.

MOTU, Digital Performer, AudioDesk, Mark of the Unicorn and the unicorn silhouette logo are trademarks of Mark of the Unicorn, Inc.

Thunderbolt and the Thunderbolt logo are trademarks of Intel Corporation in the U.S. and/or other countries.

This equipment has been type tested and found to comply with the limits for a class B digital device, pursuant to Part 15 of the FCC Rules. These limits are designed to provide reasonable protection against harmful interference in a residential installation. This equipment generates, uses, and can radiate radio frequency energy and, if not installed and used in accordance with the instruction manual, may cause harmful interference to radio communications. However, there is no guarantee that interference will not occur in a particular installation. If this equipment does cause interference to radio or television equipment reception, which can be determined by turning the equipment off and on, the user is encouraged to try to correct the interference by any combination of the following measures:

- Relocate or reorient the receiving antenna
- Increase the separation between the equipment and the receiver
- Plug the equipment into an outlet on a circuit different from that to which the receiver is connected

If necessary, you can consult a dealer or experienced radio/television technician for additional assistance.

PLEASE NOTE: only equipment certified to comply with Class B (computer input/output devices, terminals, printers, etc.) should be attached to this equipment, and it must have shielded interface cables in order to comply with the Class B FCC limits on RF emissions.

WARNING: changes or modifications to this unit not expressly approved by the party responsible for compliance could void the user's authority to operate the equipment.



Part 1

Getting Started

Quick Start Guide

Thank you for purchasing a MOTU AVB interface! Follow these easy steps to get started quickly.

- 1 Download and run the *MOTU AVB Installer*:

<http://www.motu.com/avb>

- 2 (Optional) For quick access to your MOTU interface from your iPad or iPhone, download the MOTU AVB Discovery app from the Apple App Store.

☛ Your iPhone and iPad must be on the same Wi-Fi network as your computer.

- 3 Connect the interface to your computer with a USB cable (included) or an Ethernet cable (purchased separately).

- 4 Switch on your MOTU interface.

- 5 Open the *MOTU AVB Control* web app by doing one of the following:

- From your computer, choose your MOTU interface from the MOTU AVB Discovery app menu, as shown below.

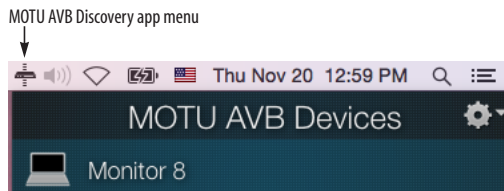

- From your iPad or iPhone, launch the MOTU AVB Discovery app, and tap your interface.
- You should now see the *MOTU AVB Control* web app in your browser, as shown on page 14. If not, visit Appendix A, “Troubleshooting” (page 71).

- For advanced network options, and device discovery from any modern browser, see chapter 9, “Networking” (page 63).

- 6 Choose a preset from the Quick Setup.

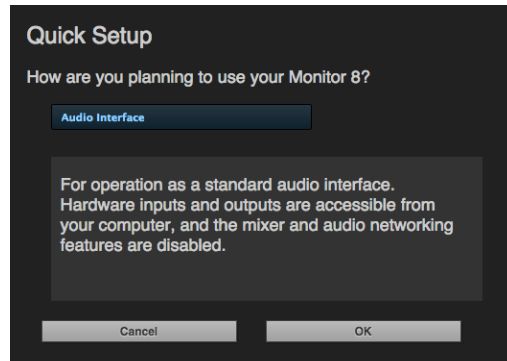

Preset	Application
Audio interface	Operate as a standard audio interface.
Stand-alone mixer	Operate as a stand-alone mixer, where all inputs are mixed to the main outs and monitor outs.
Interface + mixer	A combination of the above two presets.
Live recording with monitor mixing	Record a live concert or recording session, with a full monitor mix.
Stage I/O	Route audio inputs from one AVB interface to another, through Ethernet cabling.
Studio input expander	Routes the expansion unit’s physical inputs to the main system using AVB network streams.
Studio output expander	Routes the main systems’s AVB network streams to physical outputs on the expansion unit.
Stage I/O with monitor mixing	Routes AVB audio streams to the Monitor 8 mixer, which distributes eight separate mixes to Monitor 8’s analog outputs.
Optical converter	Multi-channel digital-to-analog converter.
Optical converter with monitor mixing	Routes the optical inputs to the Monitor 8 mixer, which distributes eight separate mixes to Monitor 8’s analog outputs.

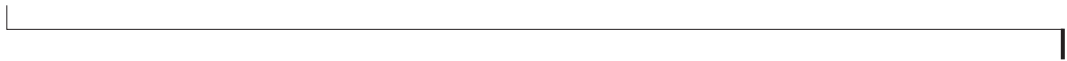

Monitor 8 Front Panel

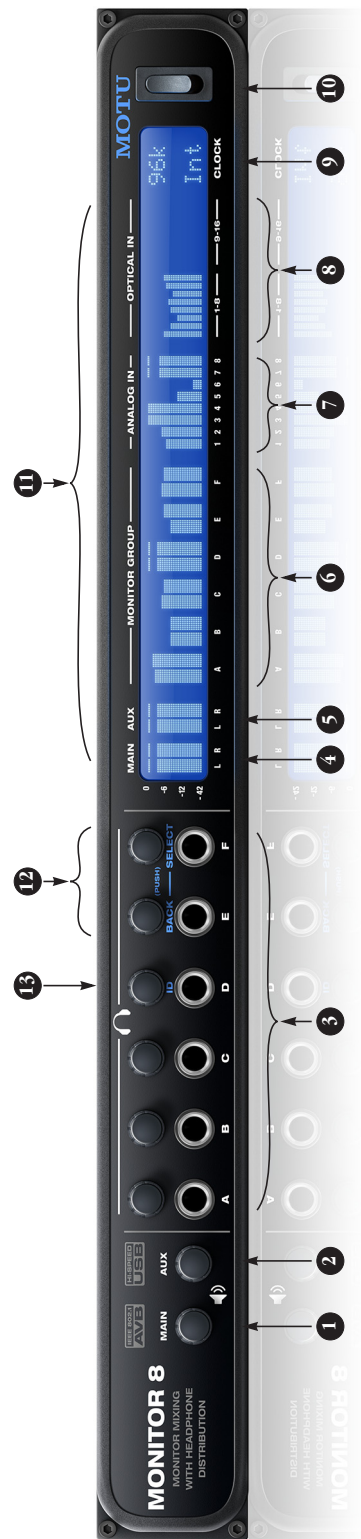

1. MAIN OUT volume control. This setting, along with all front panel settings, can also be adjusted from the MOTU Web App.
2. AUX OUT volume control.
3. PHONE OUTPUTS with volume control for each MONITOR GROUP (A-F).
4. MAIN OUT level meters.
5. AUX OUT level meters.
6. MONITOR GROUP level meters.
7. ANALOG INPUT METERS for the eight balanced (TRS) quarter-inch inputs on the rear panel.
8. ADAT OPTICAL input metering. At 1x sample rates (44.1 or 48 kHz), there are sixteen channels of input. At 2x (88.2 or 96 kHz), there are eight channels.
9. SAMPLE RATE, CLOCK and status information.
10. POWER SWITCH. AVB and USB are “plug-and-play” protocols. That means that you can turn off Monitor 8 and turn it back on without restarting your computer.
11. The multi-purpose backlit LCD displays extensive level meters for all inputs and outputs. It can also show device settings and network information, using the digital rotary encoders to the left.
12. Push SELECT to enter the LCD menu. Turn SELECT to scroll through menus and settings. Push it to select the current setting. Push BACK to return to the previous menu level, and do so repeatedly to exit the menu altogether.
13. Push ID to display the network ID for the device.

Monitor 8 Rear Panel



- The Monitor 8 is equipped with an auto-switching international power supply.
- These ADAT optical "lightpipe" jacks provide 16 channels of 24-bit ADAT optical digital input at 1x sample rates (44.1 or 48 kHz) or 8 channels at 2x sample rates (88.2 or 96 kHz). They are disabled at higher sample rates. Use them to route channels from another optical device, such as a mixer, to be included in each monitor group mix.
- The MAIN OUT pair provides stereo analog output for primary (powered) studio monitors or PA speakers or any other desired destination. Control volume from the MOTU Web App or from the front panel volume control.
- To hear audio playback from your host audio software on the MAIN OUT pair, assign audio tracks (and master fader) to these main outs. You can also use the MOTU Web App to route live Monitor 8 inputs (and network inputs) here as well.
- The AUX OUT pair provides auxiliary stereo analog output for secondary studio monitors, or any other desired destination. These connectors are balanced (tip/ring/sleeve). Control volume from the MOTU Web App or from the front panel volume control.
- Monitor Groups E and F (output channels 9–10 and 11–12, respectively) provide two mirrored outputs: 1) a headphone output, which mirrors its corresponding front panel headphone output, and 2) a summed mono output (commonly used to feed a stage monitor), which also mirrors the headphone output.
- Monitor Groups A through D provide three mirrored output pairs: 1) balanced stereo L/R (for wireless monitoring systems), 2) headphone (for wired headphone installations), and 3) summed mono (for stage monitors). All outputs within a group mirror each other and their corresponding headphone output on the front panel.
- Equipped with very high quality 24-bit 192 kHz converters, these eight analog inputs are balanced TRS (tip/ring/sleeve) quarter-inch connectors that can also accept an unbalanced plug (with the ring disconnected). Use them to include external analog sources into your monitor group mixes. These inputs are equipped with the Monitor 8's Precision Digital Trim™ feature: digitally controlled analog trims that let you adjust input level in 1 dB increments from the MOTU web app.
- Connect Monitor 8 to the computer here using a standard USB cable. If you plan to connect Monitor 8 to an AVB network, use the network port (instead of USB).
- This AVB ethernet port provides industry standard IEEE 802.1 network connectivity to other network devices. Examples include:
 - Another Monitor 8 or any other MOTU AVB-equipped device, such as the T248, 8M, T6A, Z44A or Z44o audio interfaces.
 - A standard ethernet hub or Wi-Fi router (for internet connection and communication with the web app software).
 - A standard AVB Ethernet switch for high-speed, low-latency, high-capacity audio connectivity to an AVB audio network.

MOTU AVB Switch



- Use these 1 gigabit AVB NETWORK ports to connect any of the following:
 - MOTU AVB interfaces (1248, 8M, 16A, 24Ai, 24Ao)
 - Another MOTU AVB Switch (to extend the network)
 - A 3rd-party AVB switch
 - An Ethernet device, Wi-Fi router or Ethernet network
 - A third-party AVB device
- This standard Ethernet port can be used to connect a standard 10/100/1Gb Ethernet device, Wi-Fi router or Ethernet network. DO NOT connect AVB devices to this port; it does not support AVB.
- Connect the included 15V DC power supply here. Alternately, you can use any power supply that conforms to the indicated specifications.
- The front panel LEDs indicate signal activity for each port. When a 1 gigabit device is connected to a port, the 1 Gb LED illuminates.

NOTE: When making network connections, use shielded CAT-5e or CAT-6 cables (a higher grade cable). For local connections, patch cables can be used, but will reduce the maximum total cable run length.

The MOTU AVB Switch provides deep functionality that goes beyond a standard Ethernet switch.

- No configuration is necessary. The switch configures itself and manages all device discovery, configuration, and system resource allocation.
- The switch establishes and maintains extremely accurate timing and synchronization among all connected devices.
- The switch negotiates audio routing throughout the network and guarantees that audio integrity is maintained, regardless of external (non AVB) network traffic.
- The switch consolidates audio, synchronization, and control together.

For more information, see chapter 9, "Networking" (page 63).

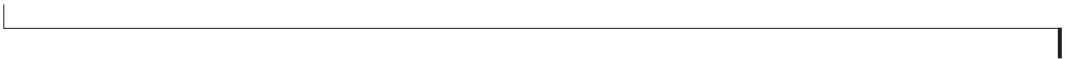

MOTU AVB Control Web App

OVERVIEW

MOTU AVB Control is a web app that gives you complete control over your MOTU audio interface. If you have several MOTU AVB interfaces networked together, such as the Monitor 8 and 8M, you can control them all. If you are working with a large-scale network of many MOTU AVB interfaces, you can access and control any device on the network.

IT'S NOT ON YOUR HARD DRIVE

The MOTU AVB Control web app is served from the audio interface hardware itself, therefore it is not an application on your computer's hard drive. Instead, access it by using the MOTU AVB Discovery Application, or through your web browser by typing your MOTU device's IP Address into the address bar.

USE YOUR FAVORITE WEB BROWSER

The MOTU AVB Control web app runs in any modern web browser on any device connected to your MOTU interface, either directly or wirelessly through a Wi-Fi network. You can use any device you wish: a desktop computer, laptop, iPad, tablet, iPhone or smart phone. If it can run a web browser, it can run the web app. You can use any browser you prefer: Chrome, Firefox, Safari, IE 11 etc. The latest versions are strongly recommended.

CONTROL FROM MULTIPLE DEVICES

You can run the web app on multiple host devices simultaneously.

RUN THE INSTALLER, GET THE APP

Visit www.motu.com/avb to get the latest MOTU AVB installer and run it on your computer to install the *MOTU AVB Discovery* app and drivers. Visit the Apple App Store to download the discovery app onto your iPad or iPhone.

MAKE HARDWARE AND NETWORK CONNECTIONS

Connect your MOTU interface to your computer or laptop with a USB cable. Make sure your iPad, iPhone, tablet or smartphone is connected to the same Wi-Fi network as your computer or device. You can use any network connection scenario explained in "Setup for web app control" on page 36.

LAUNCHING THE WEB APP

To launch the web app, do any of the following:

- From your computer, choose your MOTU interface from the MOTU AVB Discovery app menu, as shown below. If you have multiple interfaces, choose the one you want.

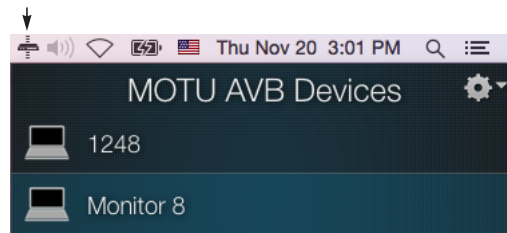

- From your iPad or iPhone, launch the MOTU AVB Discovery app.
- From any web browser on any host (computer, tablet, etc.), type in the IP address or .localname of your MOTU AVB interface. See below for how to obtain the IP address.

You should now see the MOTU AVB Control web app in your browser, as shown on page 14. If not visit Appendix A, "Troubleshooting" page (71).

Obtaining your MOTU device's IP address

On the front panel of the interface, push the ID knob or button once. The LCD now displays the unit's IP address, which should look something like this: "IP Address: 192.168.1.209".

DEVICE TAB

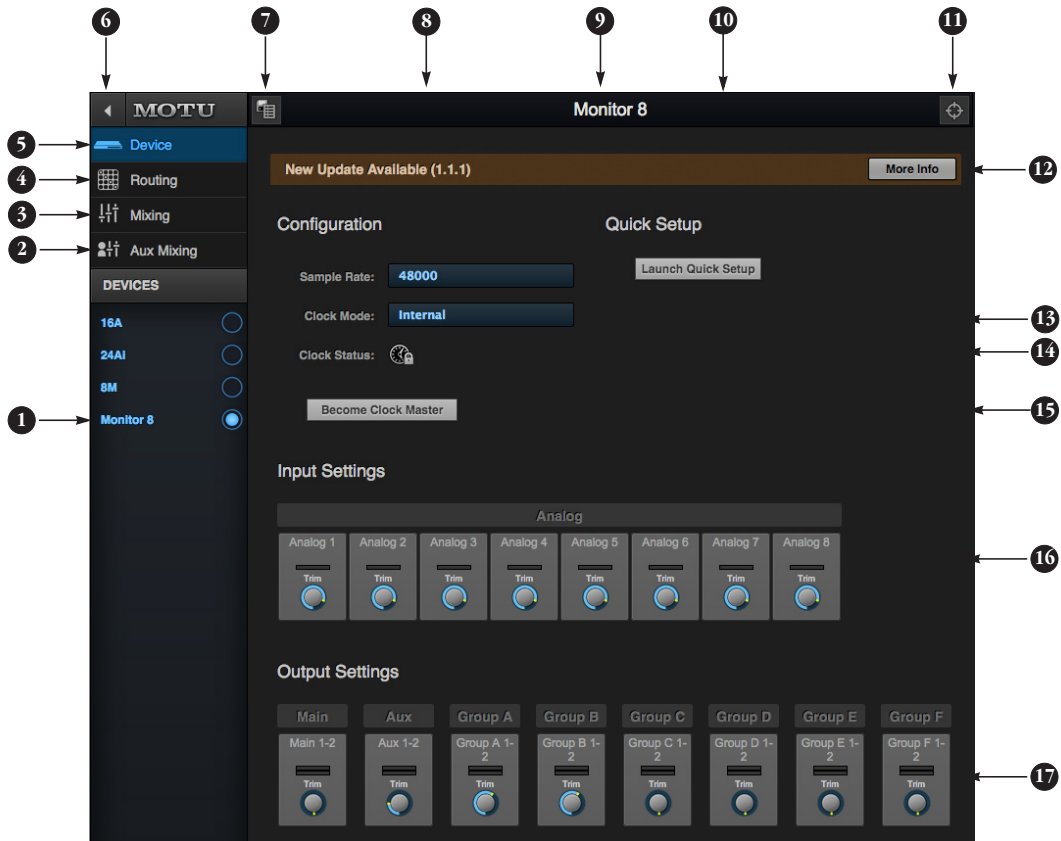

1. If you have two or more MOTU AVB interfaces, the Device list lets you choose the one you are currently controlling with the web app.
2. The Aux Mixing tab lets you view each Aux bus in the mixer, one at a time.
3. The Mixing tab gives you access to the mixing and DSP in the interface.
4. The Routing tab displays a grid matrix, where you can make direct connections between inputs and outputs, your computer, the mixer, and network audio streams, if networked interfaces are connected.
5. The Device tab has settings for the hardware itself, such as analog input and output trim.
6. Expands and collapses the sidebar.
7. Lets you create, save, recall and manage presets for your MOTU AVB interface. These presets capture and recall the complete state of the device (all settings in all tabs).
8. Choose the desired sample rate.
9. Click to rename the interface. To restore the default name, delete the current name.
10. The Quick Setup button prompts factory presets used to configure your interface for a specific application. See chapter 5, "Presets" (page 43).
11. Click this device ID button to identify the unit you are currently viewing and controlling with the web app software. The front panel LCD on the hardware itself will flash the name of the device, and its name will also flash in the Device list (1).
12. If an update is available for your device, and the computer you are viewing it from is connected to the internet, you'll be notified here. Click More Info to learn what's new and start the update process.
13. Choose the clock source from the Clock Mode menu. Your MOTU device will resolve its digital clock to this master source.
14. The Clock Status icon indicates that the current device (1) is successfully resolved to its chosen Clock Mode source (13). If it cannot lock for some reason, this icon flashes red. Check your chosen clock source, cables, etc.
15. If you have multiple MOTU AVB interfaces, one of them may serve as a master clock source for the network. Click the *Become Clock Master* button to choose the current interface (1) as the master clock source.
16. The Input Settings provide digitally controlled analog trim from -96 to +22 dB.
17. The Output Settings provide full volume range from -127 to zero.

DEVICE TAB (CONTINUED)

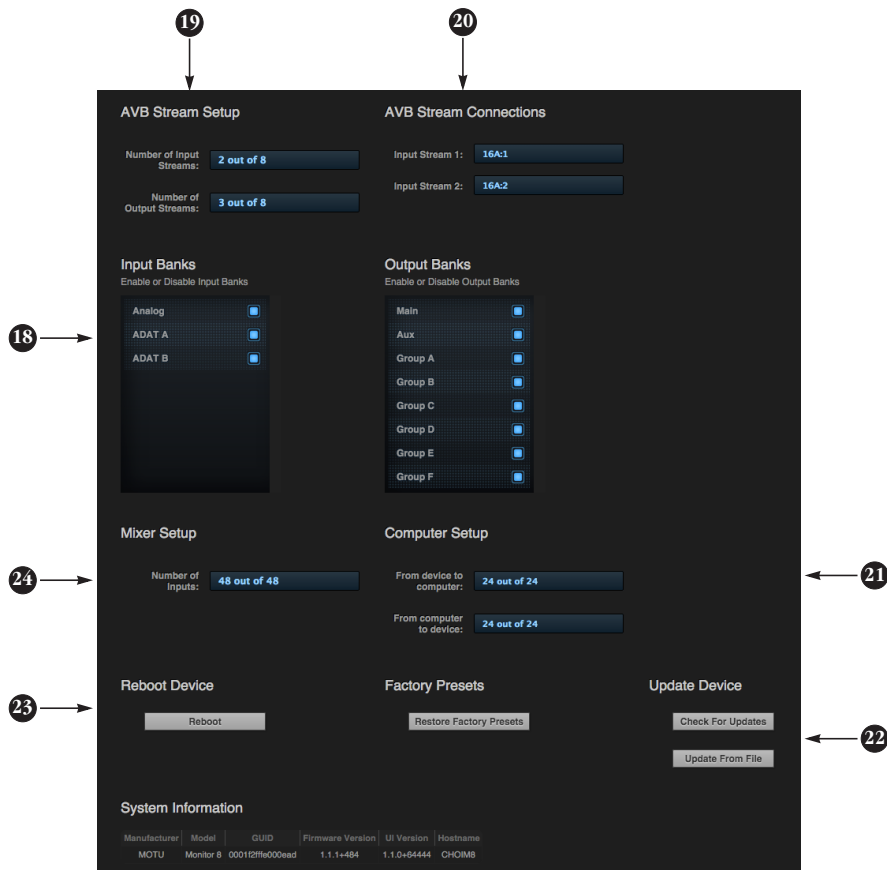

Scroll down to view these additional Device tab settings.

18. In the Input/Output Banks sections, you can disable any banks that you are not using. Doing so hides them from the routing matrix and mixer to simplify operation. Doing so also helps conserve DSP resources.
19. AVB is IEEE's Audio Video Bridging Ethernet standard for high-bandwidth, low-latency audio streaming over Ethernet. If your Monitor 8 is connected to a 2nd MOTU AVB interface through its network port, or to an AVB switch for access to an extended AVB network,

you can stream audio channels to and from other devices on the network. AVB streams are handled in banks of eight channels, so if you enable 8 out of 8 streams, that's 64 channels. See chapter 9, "Networking" (page 63).

20. If you have AVB network input streams enabled, connect them to the output streams of other devices on the network here. This is how you route audio from the other devices to the Monitor 8.
21. In the Computer Setup section, you can specify how many audio channels you would like to be able to

stream to and from your computer, up to 24 channels each way, simultaneously. Map them as desired in the Routing tab (page 16).

22. Use these buttons to manually check for and install updates for your MOTU AVB device. For complete details, see Appendix D, "Updating Firmware" page (79). Updating from a file can be done offline from your computer, using an update you've obtained through MOTU's web site or tech support department. The *Check For Updates* button requires that the computer (or device) you are using to view your MOTU AVB interface is connected to the inter-

net through a local network or Wi-Fi. Updating from the internet is easy and convenient.

23. Use these buttons to reboot (restart) the device, or restore its factory presets.
24. The digital mixer in your MOTU AVB interface supports up to 48 channels. If you don't need that many inputs, you can lower the number here to simplify mixer and routing operation and conserve DSP bandwidth for effects processing.

ROUTING TAB

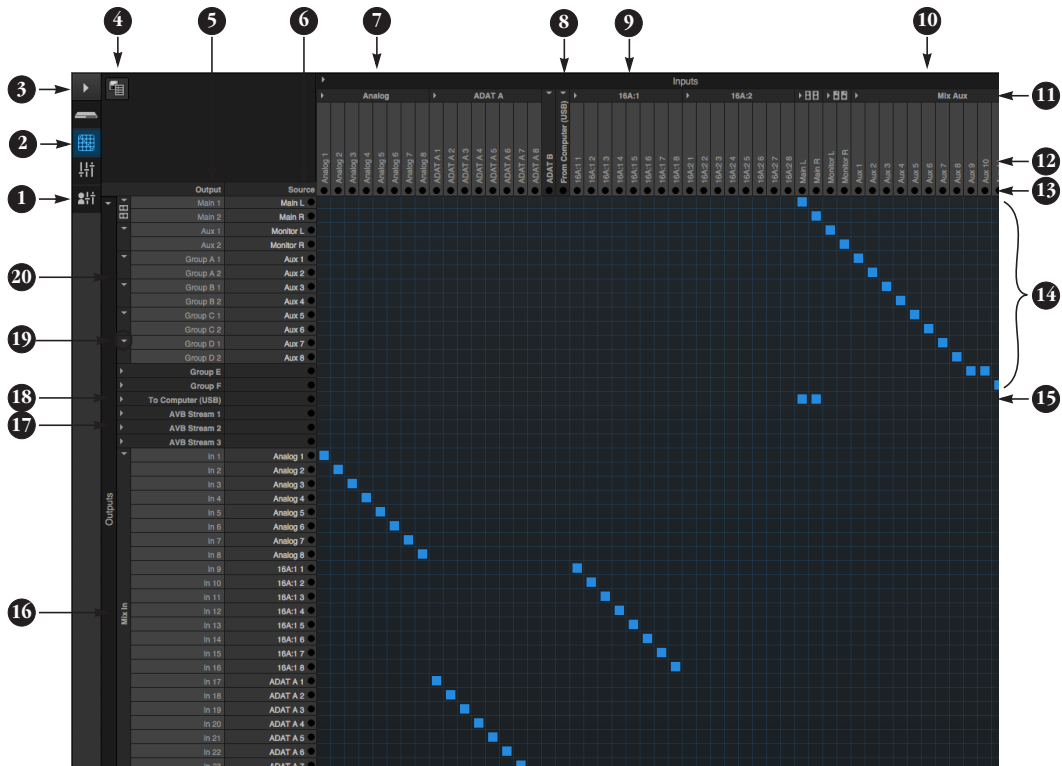

The Routing Tab lets you route inputs to outputs. Outputs are listed by row on the left; inputs are listed in columns across the top. Simply click in the grid to make a single connection. Click and drag to make multiple connections in one gesture. To route a single input to multiple outputs, make multiple connections vertically in the same column below the input. To mix multiple inputs to the same output, you'll need to use the mixer (page 17) and the *Mix In* bank in the routing tab (16).

1. In its collapsed form, (shown here), the sidebar displays icons for each tab.
2. Click this icon to view the Routing tab, shown on this page.
3. Click here to show or hide the sidebar.
4. Create, save, recall and manage routing presets.
5. Outputs are listed in rows on the left.

6. When you make a connection, the source (input) signal is listed by name here in the Source column, just to the right of the output it is being routed to.
7. Inputs are listed in columns across the top of the grid, starting with the physical inputs on the hardware itself. In this example, the eight analog inputs are routed to the mixer, along with eight ADAT digital inputs and an 8-channel network stream from a 16A interface.
8. The *From Computer* input bank lets you route audio channels from your host audio software to any output, including AVB network streams or the mixer, where you can mix computer audio with local inputs. Use the Device tab to choose how many computer channels are available.
9. AVB streams are 8-channel banks that let you route audio to or from other devices on the AVB network (if any are connected) to local hardware inputs and outputs. Use

the Device tab (page 15) to configure how many AVB streams you wish to work with. If you aren't working with network audio, you can set the number of streams to zero (0).

10. These input streams are busses that originate from the mixer, which supplies the main mix bus, monitor mix bus, seven stereo aux busses, three stereo group busses, a reverb return bus and postFX channel sends (for sending processed inputs to the computer or elsewhere). You can route these mixer busses to any outputs you wish (5), including physical outputs, host software on your computer, other devices on the AVB network, or even back in to the mixer (beware of feedback loops!)
11. Use these triangles to expand or collapse groups of inputs. For example, it might be convenient to collapse banks that you are not using at the moment.
12. Click a channel label to rename it.
13. Audio activity indicators.

14. Here, outputs from the mixer are being routed to outputs on the Monitor 8. The Main Mix and Monitor busses are being routed to the Main Outs and Aux Outs, respectively. Mixer Aux busses are being routed to Monitor Groups A-F.
15. Click the grid to make a connection. Click a connection to remove it. Click and drag to make or break multiple connections in one gesture.
16. The *Mix In* group lets you route audio to the 48-channel mixer.
17. These AVB output streams let you route any audio to other devices on the AVB network.
18. The *To Computer* output bank routes any input to host audio software running on your computer. Use the Device tab to choose how many computer channels are available.
19. Use these triangles to expand or collapse groups of outputs.
20. These are the physical outputs on the interface itself.

MIXING TAB

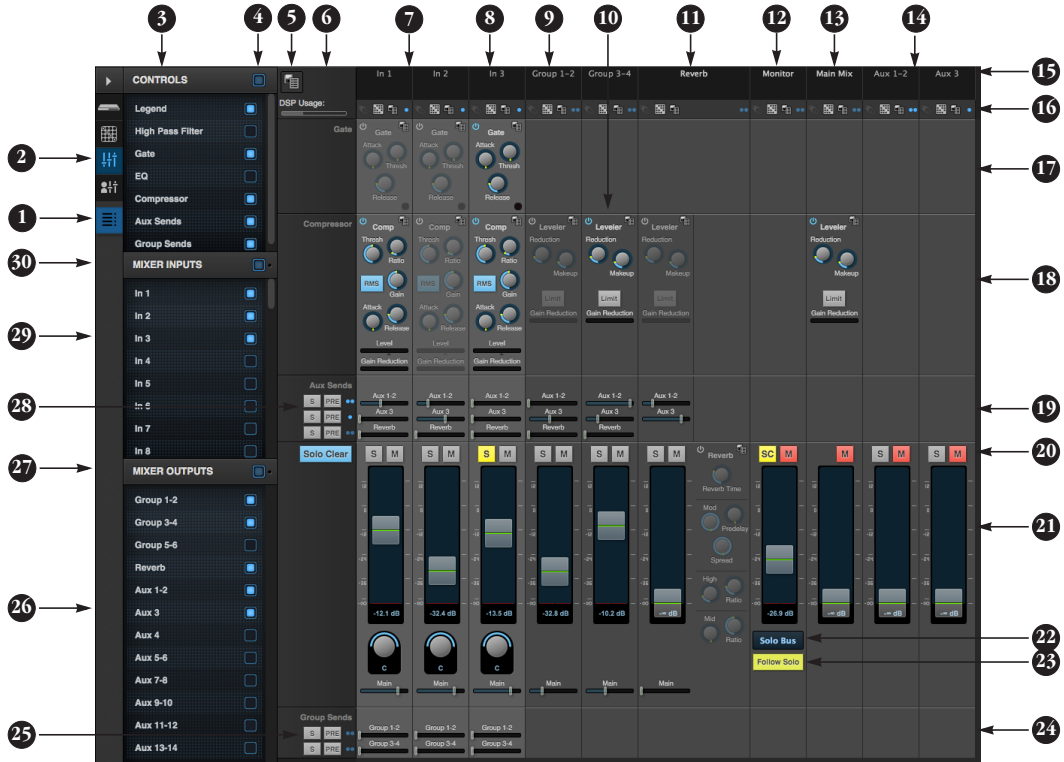

The Mixing tab gives you full access to the 48-channel mixer in your MOTU AVB interface, which provides a main mix bus, monitor bus, three group busses, seven aux busses, and a dedicated reverb bus. Use the Device tab to configure how many inputs you wish to work with (up to 48). Use the Routing tab (page 16) to route channels to the mixer inputs. Channels can come from any source, such as the physical inputs on the interface, channels coming from the computer, or channels coming from the AVB network.

- Shows and hides the Mixer Setup sidebar (3), which lets you show and hide channels, channel strip settings, effects, and the Legend (6).
- The Mixing tab selects the mixer.
- Use the Mixer Setup sidebar to show and hide elements in the mixer.
- Shows and hides all elements in the section with one click.
- Create, save, recall and manage mixer presets.

- This column is the Legend. It provides labels and controls for channel strip sections. The menu at the top lets you create, name, save and manage entire mixer presets.
- Mixer input channels.
- This input channel has its Gate and Compressor enabled. Disabled effects are grayed out.
- This is Group bus 1-2. You can send inputs to this group with their Group send fader (24) or aux busses (19).
- Group busses, the main mix bus, and the reverb return bus are equipped with the Leveler, a vintage compressor modeled after the Teletronix LA-2A leveling amplifier.
- The reverb channel strip provides controls for the reverb processor. Use the reverb send on individual inputs or groups to route them to the reverb bus, which can then be mixed

in with the main mix or aux busses. Disable the reverb processor to use it as an extra group.

- The Monitor Bus can mirror the output of any other bus, or it can act as a separate Solo bus. See page 24.
- The Main Mix bus is the master fader for the entire mixer. You can add EQ and Leveler compression.
- You can adjust Aux bus output levels here, or in the Aux Mixing tab shown on page 18.
- Click a name to change it, except for the Main Mix, Monitor, and Reverb busses, which cannot be changed.
- Stereo toggle to switch channels pairs between mono or stereo. Use the other menus to manage channel strip presets and to choose audio sources and destinations for mixer inputs and bus outputs.
- Gate processing for inputs.
- The Dynamics section provides a conventional compressor for inputs and the Leveler for output busses.

- Reverb and aux sends.
- Solo and mute. On the Monitor bus, the SC button clears all solos.
- Channel faders.
- Choose the source for the Monitor bus from this menu. It can mirror any output bus or the Solo Bus.
- When *Follow Solo* is enabled, the Monitor bus temporarily switches to the solo bus when any channel is soloed.
- Group sends.
- 'S' lets you solo the group. 'PRE' toggles the sends between pre- and post-fader routing, i.e. before or after the channel fader.
- Show and hide output busses here.
- Show/hide all busses with one click.
- Same as (24) above.
- Show and hide inputs here.
- Show/hide all inputs with one click.

AUX MIXING TAB

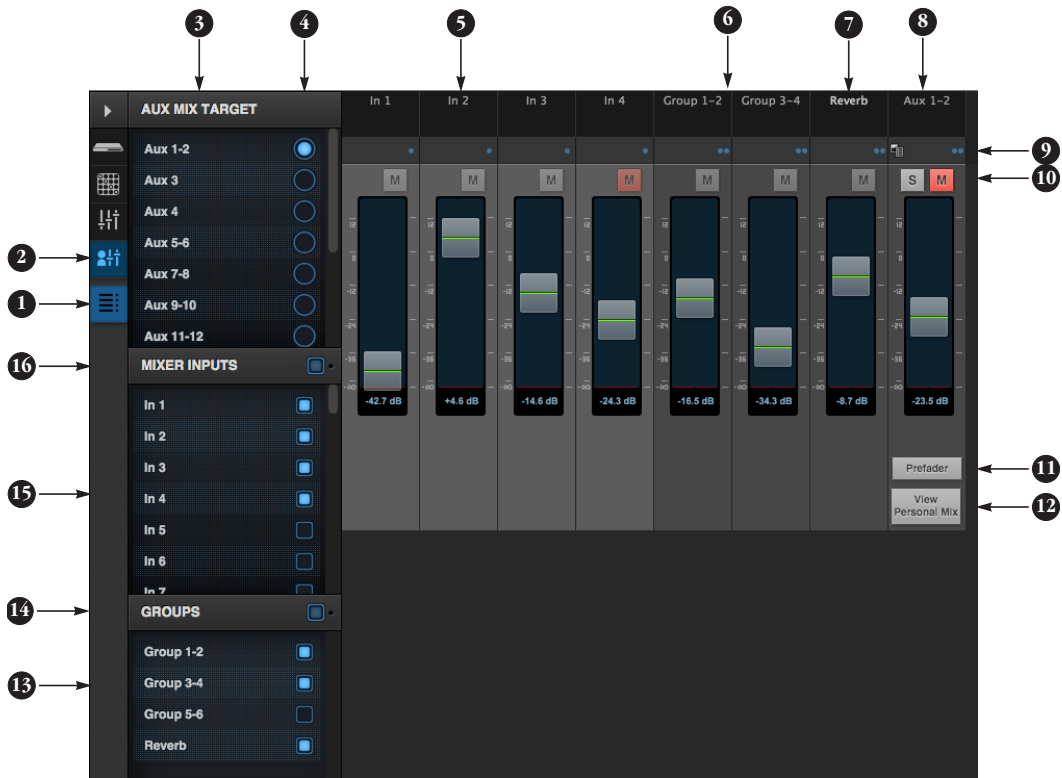

The Aux Mixing tab provides quick access to your MOTU AVB interface's mix busses (aux busses, groups and reverb bus), viewed one at a time. Choose a bus in the Aux Mix Target section and then use the faders to directly mix the send levels from all mixer inputs, groups, and the reverb bus.

- Shows and hides the Mixer Setup sidebar (3), which lets you show and hide channels.
- The Aux Mixing tab (shown on this page) gives you access to the Aux busses and groups in the mixer.
- Use the *Aux Mix Target* sidebar to control which aux bus or group you are currently viewing. You can also show/hide inputs and group sends.
- Click the aux bus or group you wish to view in the window. In this example, Aux bus 1-2 is being displayed.
- These are mixer inputs (aux sends from each mixer channel). To include an input in the aux bus mix, simply bring up its fader.
- These are group bus faders.
- This is the mixer's reverb bus fader.
- This is the master fader for the current aux bus being viewed (4).
- Indicates if the input or group is stereo or mono. This indicator is for display purposes only. To toggle between mono and stereo operation, use the toggle switch in the Mixing tab (item #16 on page 17).
- Solo and mute for the aux bus master fader.
- When *Prefader* is enabled, all send levels to the aux bus are independent of the main fader for each channel. In other words, changing an individual channel's main fader in the Mixing tab won't affect its send level to the aux bus.
- Click the View Personal Mix button to open a new web page that displays only that specific Aux Mix or Group.
- Show and hide mix groups and the reverb bus here.
- Use the Groups button here to show or hide all groups with one click.
- Show and hide mixer inputs (channel sends) here.
- Show and hide all mixer inputs with one click here.

MIXER INPUT CHANNEL STRIPS

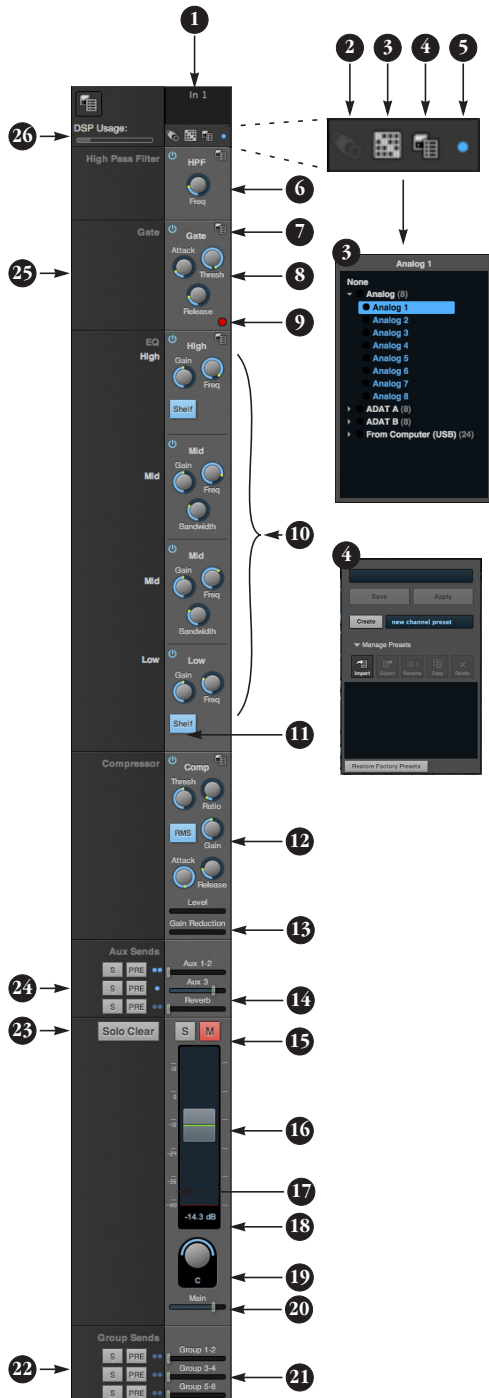

To access a mixer input channel strip, go to the Mixing tab (page 17), reveal the side bar (item #3 on page 17), and then show the input channel you want in the *Mixer Inputs* section (29).

To show and hide sections of the channel strip, such as EQ or the compressor, use the *Controls* section of the side bar (item #3 in the mixer tab on page 17).

1. Click the input channel name to change it. Delete the current name to restore the default name.

2. Provides hardware settings for inputs, if any, on other MOTU AVB interfaces. If there are no hardware settings for the assigned input, this icon is grayed out.

3. Choose the source for the input channel. You can also make this setting directly on the Routing grid (page 16).

4. Create, name, save and recall channel strip presets.

5. Toggles the input between mono and a stereo pair.

6. High Pass Filter with cutoff frequency.

7. Each effect in the channel strip (High Pass Filter, Gate, EQ, etc.) has an on/off button (on the left) and a preset menu on the right, for managing presets that apply only to that processing module. For example, you can create your own EQ presets for the EQ modules.

8. The Gate processor provides standard attack, threshold and release controls.

9. The Gate indicator turns red when the gate is engaged.

10. The EQ section provides four bands of parametric EQ, each with standard Gain, Frequency, and Bandwidth settings.

11. The High and Low EQ bands provide a *Shelf* filter button for standard high and low shelf filtering.

12. The Compressor provides standard controls for Threshold, Ratio, Attack, Release and Gain. Normally, the compressor operates in Peak mode, where signal peaks determine the

input level. Engage the RMS button to uses RMS values (a computational method for determining overall loudness) to measure the input level.

13. Input level and gain reduction meters for the compressor.

14. Aux and reverb sends.

15. Solo/Mute. Mute affects all sends as well as the main channel. Pre-fader sends are not affected by Mute.

16. Move the fader to adjust level. Double-click to return to zero (unity gain) or $-\infty$.

17. Click the dB scale numbers to make the fader jump exactly to that level. Click and drag horizontally to jump consecutive faders to the same level.

18. Click to type in an exact dB level.

19. Channel pan. For mono inputs, double-click to center.

20. Main Mix Slider is used to feed signal to the Main Mix. Slider is set to 0 dB by default, so all channel strips are pre-routed to the Main Mix bus. If a channel is being sent to a Group (which will eventually be fed to the Main Mix), drag the slider to $-\infty$ so it is not sent to Main Mix directly.

21. Group sends.

22. 'S' lets you solo the group. 'PRE' toggles the sends between pre- and post-fader routing, i.e. before or after the channel fader.

23. Clears all solos.

24. 'S' lets you solo the Aux bus. 'PRE' toggles the sends between pre- and post-fader routing, i.e. before or after the channel fader. The dots let you toggle the Aux bus between mono and stereo.

25. This side bar, with the section labels in it, can be shown or hidden using the *Legend* switch in the *Controls* section of the side bar (item #3 in the mixer tab on page 17).

26. Shows how much DSP power is being used by the mixer hardware. To free up DSP bandwidth, try reducing the number of mixer ins, disabling channel effects, reverb, etc. See "DSP Usage" on page 62 for more info.

MAIN MIX AND MONITOR CHANNEL STRIPS

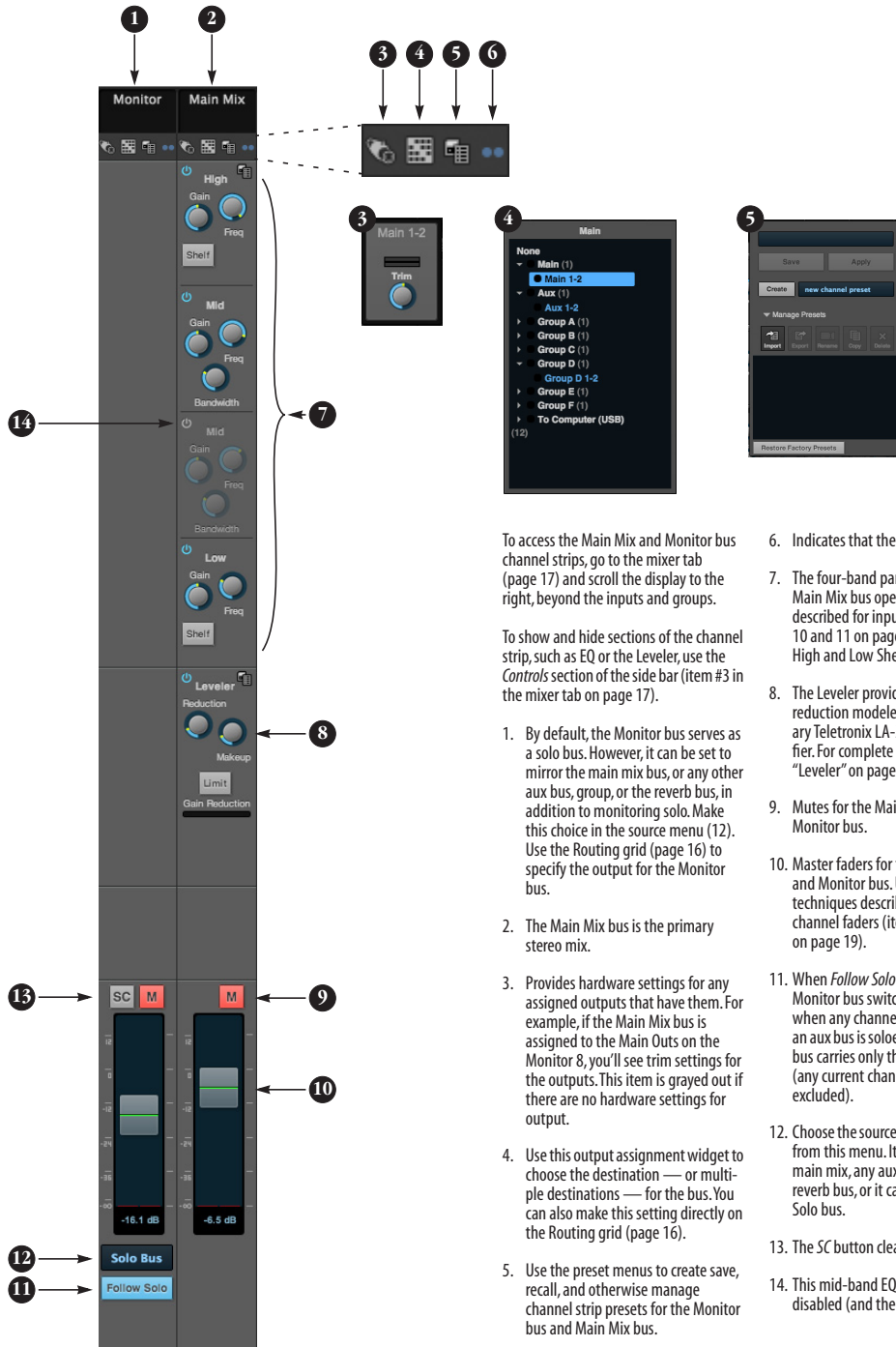

To access the Main Mix and Monitor bus channel strips, go to the mixer tab (page 17) and scroll the display to the right, beyond the inputs and groups.

To show and hide sections of the channel strip, such as EQ or the Leveler, use the *Controls* section of the side bar (item #3 in the mixer tab on page 17).

1. By default, the Monitor bus serves as a solo bus. However, it can be set to mirror the main mix bus, or any other aux bus, group, or the reverb bus, in addition to monitoring solo. Make this choice in the source menu (12). Use the Routing grid (page 16) to specify the output for the Monitor bus.

2. The Main Mix bus is the primary stereo mix.

3. Provides hardware settings for any assigned outputs that have them. For example, if the Main Mix bus is assigned to the Main Outs on the Monitor 8, you'll see trim settings for the outputs. This item is grayed out if there are no hardware settings for output.

4. Use this output assignment widget to choose the destination — or multiple destinations — for the bus. You can also make this setting directly on the Routing grid (page 16).

5. Use the preset menus to create, save, recall, and otherwise manage channel strip presets for the Monitor bus and Main Mix bus.

6. Indicates that the bus is stereo.

7. The four-band parametric EQ for the Main Mix bus operates the same as described for input channels (items 10 and 11 on page 19), including High and Low Shelf filter options.

8. The Leveler provides specialized gain reduction modeled after the legendary Teletronix LA-2A Leveling Amplifier. For complete details, see "Leveler" on page 60.

9. Mutes for the Main Mix bus and Monitor bus.

10. Master faders for the Main Mix bus and Monitor bus. Use the same techniques described for input channel faders (items 16, 17 and 18 on page 19).

11. When *Follow Solo* is enabled, the Monitor bus switches to the solo bus when any channel is soloed. NOTE: If an aux bus is soloed, then the Monitor bus carries only the soloed aux bus (any current channel solos are excluded).

12. Choose the source for the Monitor bus from this menu. It can mirror the main mix, any aux bus, group, the reverb bus, or it can serve only as a Solo bus.

13. The SC button clears all solos.

14. This mid-band EQ is currently disabled (and therefore grayed out).

AUX BUS CHANNEL STRIPS



Aux busses can be used to create sub-mixes. An aux bus can be assigned to any output in the Routing grid (page 16).

To access an Aux bus channel strip, go to the mixer tab (page 17), reveal the side bar (item #3 on page 17), and then show the aux busses you want in the *Mixer Outputs* section (26).

To show and hide the four-band EQ section of the channel strip, use the *Controls* section of the side bar (item #3 in the mixer tab on page 17).

1. A stereo aux bus.
2. A mono aux bus.
3. Click this dot to toggle an aux bus between mono and stereo.
4. The four-band parametric EQ module for Aux busses operates the same as described for input channels (items 10 and 11 on page 19), including High and Low Shelf filter options.
5. Aux bus solo and mute.
6. Aux bus master fader.
7. Click to type specific value manually.
8. Click the dB scale numbers to make the fader jump exactly to that level. Click and drag horizontally to jump consecutive faders to the same level.
9. A disabled EQ band.
10. Use these menus (hardware settings, output assignment, and presets) in a similar fashion as described for the Main Out bus (items 3-5 on page 20).

GROUP AND REVERB CHANNEL STRIPS



Group buses can be used to create a mix sub-group, which is a set of inputs you wish to control together as a group. Groups differ from aux buses in that they have aux sends, a reverb send, as well as a main mix send. In addition, group buses are equipped with the Leveler.

The Reverb bus is a special group bus that provides a reverb processor. If you disable the reverb, the reverb bus functions as a (fourth) regular group bus.

To access the Group and Reverb bus channel strips, go to the mixer tab (page 17), reveal the side bar (item #3 on page 17), and then show the desired Group buses or Reverb bus in the *Mixer Outputs* section (26).

To show and hide the four-band EQ section of the channel strip, use the *Controls* section of the side bar (item #3 in the mixer tab on page 17).

1. A Group bus channel strip. Click the name to rename it. Delete the current name to return to its default.
2. The Reverb bus. If you disable the Reverb processor, it can be used as a fourth Group bus. The Reverb channel strip is twice as wide as other mixer channel strips to accommodate the Reverb processor controls.
3. Group buses and the Reverb bus are always stereo.
4. The four-band parametric EQ module for Group buses and the Reverb bus operates the same as described for input channels (items 10 and 11 on page 19), including High and Low Shelf filter options.
5. The Reverb processor. For complete information, see "Reverb" on page 61.
6. Main Mix sends.
7. Master faders for the Group and Reverb buses.
8. Mute and Solo.
9. Use these menus (hardware settings, output assignment, and presets) in a similar fashion as described for the Main Out bus (items 3-5 on page 20).

CHAPTER 1 About the Monitor 8

Monitor 8 is a 24 x 16 x 8 monitor mixer, 6-channel headphone amplifier and USB/AVB audio interface with console-style 48-channel mixing and DSP effects. Monitor 8 can mix 24 inputs, multi-channel computer audio, and dozens of AVB audio network channels to eight stereo busses: Main, Aux and monitor groups A thru F.

The Monitor 8 can operate as an audio interface for a studio workstation (DAW), as a standalone mixer, or as an auxiliary monitor mixing system in the studio or on stage. The following sections provide a brief overview of its main features and characteristics.

State-of-the-art A/D and D/A conversion

Monitor 8's analog section employs state-of-the-art 24-bit DACs or ADCs, which deliver analog recording and playback with remarkably high dynamic range at sample rates from 44.1 to 192 kHz.

Complementary I/O configurations

Monitor 8 delivers an exceptional amount of analog and digital audio I/O. In addition, it is designed to complement MOTU's other AVB-equipped audio interfaces, to deliver a wide range of I/O options. You can mix and match several interfaces and operate them as a unified I/O and mixing system. The following sections provide a bird's-eye glance of the I/O configurations offered by each interface in the MOTU AVB family.

Each interface provides a variety of analog and digital interconnects, all active simultaneously, designed to provide everything you need for a well-equipped recording studio.

Monitor 8

40 simultaneous audio channels (54 connections)

Connection	Input	Output
Quarter-inch analog on bal/unbal TRS	8	10
XLR main out	-	2
Summed mono quarter-inch out	-	6
Headphone outs	-	12
ADAT optical digital (at 44.1 or 48 kHz)	16	-
Total I/O connections	24	30
Total I/O channels (discrete channels)	24	16

Network I/O

Monitor 8 is also capable of handling eight 8-channel banks of network audio input and output for an additional 64 channels of simultaneous audio I/O.

Other MOTU AVB interfaces

The Monitor 8 is part of a larger family of audio interfaces, summarized below, with complementary I/O configurations.

1248

66 simultaneous audio channels

Connection	Input	Output
Quarter-inch analog on bal/unbal TRS	8	12
Mic inputs with individual preamps on XLR	4	-
Hi-Z guitar inputs	2	-
Headphone output	-	2 x stereo
ADAT optical digital (at 44.1 or 48 kHz)	16	16
RCA S/PDIF digital up to 96 kHz with SRC	stereo	stereo
Total	32	34

8M

50 simultaneous audio channels

Connection	Input	Output
Quarter-inch analog on bal/unbal TRS	-	8
Mic/guitar inputs on combo XLR/TRS	8	-
Headphone output	-	stereo
ADAT optical digital (at 44.1 or 48 kHz)	16	16
Total	24	26

16A

64 simultaneous audio channels

Connection	Input	Output
Quarter-inch analog on bal/unbal TRS	16	16
ADAT optical digital (at 44.1 or 48 kHz)	16	16
Total	32	32

24Ai

72 simultaneous audio channels

Connection	Input	Output
Balanced analog on 3x D-sub or 6x Phoenix	24	-
ADAT optical digital (at 44.1 or 48 kHz)	24	24
Total	48	24

24Ao

72 simultaneous audio channels;

Connection	Input	Output
Balanced analog on 3x D-sub or 6x Phoenix	-	24
ADAT optical digital (at 44.1 or 48 kHz)	24	24
Total	24	48

Universal connectivity

The Monitor 8 can connect to a computer with high-speed USB 2.0, which is compatible with USB 3.0). It is USB audio class-compliant, which means that it is iPad compatible (with a camera connection kit) and does not require driver installation for USB connection to a computer.

On-board DSP with mixing and effects

Monitor 8 is equipped with a powerful DSP engine that drives both an extensive routing matrix and a 48-input digital mixer with 12 stereo busses and effects. The mixer offers familiar operation modeled after large format mixing consoles.

32-bit floating point processing

All of the mixing and effects processing in the DSP engine is handled with 32-bit floating point calculations, to maintain and deliver virtually unlimited headroom and the utmost in sound quality.

Modeled vintage effects processing

Effects include “classic” reverb, compression modeled after the legendary Teletronix LA-2A compressor, and 4-band EQ modeled after British analog console EQs.

AVB system expansion and audio networking

AVB stands for the IEEE 802.1 *Audio Video Bridging* Ethernet standard for high-bandwidth, low-latency audio streaming over Ethernet. The AVB Ethernet network port on each MOTU interface lets you add a second AVB-equipped MOTU interface using any standard CAT-5e Ethernet cable. You can network up to five MOTU interfaces together using a MOTU AVB Switch™ (sold separately), and then run them as a stand-alone network or as an extended bank of I/Os for your computer-based production system (or both). You can even connect multiple computers, each with full access to all devices on the network (including the other computers).

With additional standard AVB switches (from MOTU or other brands) and standard Ethernet cabling, you can build an extensive AVB audio network. The entire network operates with near-zero network latency, even over very long cable runs. MOTU’s AVB implementation allows you to stream hundreds of audio channels among devices

and computers on the network with guaranteed Quality of Service (QoS), prioritizing audio streams over less important traffic.

Matrix routing and multing

Each MOTU interface provides completely flexible matrix-style audio routing and multing. You can route any analog or digital input, computer channel, or network stream to any other output, computer, or network device. You can also mult any single input to unlimited multiple output destinations.

24 channels of network audio I/O for your host computer

The Monitor 8 lets you stream up to 24 audio channels in and out, simultaneously, through its USB connection to a host computer. Sources and destinations can include inputs and outputs on the device, inputs and outputs on other interfaces on the network, and even audio software apps running on other computers connected to other devices on the network.

Web app control

You can control on-board DSP, mixing, device settings, clock/sync settings, and network audio routing from the MOTU AVB Control web app software running in your favorite browser on a laptop, tablet or smart phone connected to your MOTU interface directly, or through your local Wi-Fi network. Multiple devices can be used simultaneously to access any audio interface settings on the network.

Stand-alone mixing with wireless control

If you connect your MOTU interface to an Apple Airport or other Wi-Fi router with a standard Ethernet cable, you can control its powerful mixing and DSP effects from your smart phone or tablet, without a computer — great for live sound mixing from your iPad, tablet, or other wireless device.

ADAT digital input

Monitor 8 provides two 8-channel banks of optical digital input. Connect a digital mixer or other gear: 16 channels at 44.1/48 kHz or 8 channels at 88.2/96 kHz.

Comprehensive metering

The large backlit LCD displays all signal activity at a glance with detailed metering for all analog and digital I/O. You can access many hardware settings directly from the front panel.

Precision Digital Trim™

Analog inputs are equipped with digitally controlled analog trims, adjustable in 1 dB increments. Analog outputs offer 32 bit trim in the DAC, also adjustable in 1 dB increments. You can save your trim configurations as a preset for instant recall.

Rack mount or desktop operation

Monitor 8 is housed in a sturdy, metal-alloy, 19-inch, rack-mountable unit. The rack mounting brackets can be removed using a 7/64" hex wrench for desktop operation.

AudioDesk

AudioDesk is a full-featured, audio workstation software package included with Monitor 8. AudioDesk provides multi-channel waveform editing, automated virtual mixing, graphic editing of ramp automation, real-time effects plug-ins with crossfades, support for many third-party audio plug-ins, sample-accurate editing and placement of audio, and more.

CHAPTER 2 **Packing List and System Requirements**

PACKING LIST

Your MOTU interface ships with the items listed below. If any of these items are not present in the box when you first open it, please immediately contact your dealer or MOTU.

- One audio interface
- One USB cable
- One power cord
- One manual
- Product registration card

SYSTEM REQUIREMENTS

- A 1 GHz Intel-based Mac. Faster CPUs are recommended for best performance.
- 2 GB RAM or more recommended.
- OS X 10.8 or later; for operation as an AVB Ethernet audio interface, OS X 10.10 or later is required.
- Available high-speed USB 2.0 port.
- A large hard drive (preferably at least 500 GB).

PLEASE REGISTER TODAY!

Please register your MOTU interface today. There are two ways to register.

- Visit www.motu.com/register

OR

- Fill out and mail the included product registration card

As a registered user, you will be eligible to receive technical support and announcements about product enhancements as soon as they become available. Only registered users receive these special update notices, so please register today.

Be sure to do the same for the included AudioDesk software, which must be registered separately. You can do so online or by filling out and mailing the included software registration card found at the beginning of your AudioDesk manual.

Thank you for taking the time to register your new MOTU products!

CHAPTER 3 **Software Installation**

OVERVIEW

USB 2.0 class-compliant operation.....	29
Operation as an AVB Ethernet audio interface	29
Software installation.....	29
Run the MOTU AVB Audio Installer	30
MOTU AVB Discovery app	30
AudioDesk workstation software	30

USB 2.0 CLASS-COMPLIANT OPERATION

Your MOTU interface is a USB 2.0 audio class-compliant device. This means that you can connect it to your computer with a USB cable and use it without installing any software drivers. The computer recognizes your MOTU interface as a USB audio device and makes its inputs and outputs available to your host audio software. Basic settings, such as the hardware's sample rate, are made in either your host software (Mac) or your system settings (Windows).

☛ In this scenario, your MOTU interface provides basic audio input and output, and no software driver installation is necessary.

As explained earlier in this guide, the MOTU AVB Control web app provides full access to all settings in the device, including the extensive on-board routing, mixing, and effects processing features. Since the web app is served from the audio interface hardware itself, it does not require any software installation on your computer; all it requires is a network connection between your computer and your MOTU interface with a standard Ethernet cable, Ethernet hub, or shared Wi-Fi network. For details about accessing the web app through the network port, see “MOTU AVB Control Web App” on page 13.

OPERATION AS AN AVB ETHERNET AUDIO INTERFACE

To use Monitor 8 as an audio interface over AVB Ethernet, all you need is a recent Mac (any Mac that has a Thunderbolt port on it) with Mac OS X Yosemite (10.10) or later installed. Connect the network port on the Monitor 8 to the Ethernet port on the Mac using a standard, high-grade (CAT-5e or CAT-6) network cable up to 100 meters in length. You can then use Monitor 8 as a standard, low-latency multi-channel audio interface with any Core Audio compatible host software running on the Mac.

☛ In this scenario, your MOTU interface provides basic audio input and output, and no software driver installation is necessary.

For details about accessing device settings in the web app through a network port connection, see “MOTU AVB Control Web App” on page 13.

SOFTWARE INSTALLATION

Software installation is required for any of the following scenarios:

- You will use Monitor 8 as a USB audio interface, and you want to access the web app without the network port.
- You wish to use the included AudioDesk workstation software.
- You will be using multiple MOTU interfaces.

If none of the above scenarios apply to you, then you can skip software installation if you wish, and proceed to details about accessing the web app through the network port, see “MOTU AVB Control Web App” on page 13.

Run the software installer before connecting your MOTU interface to your computer

If you wish to proceed with software installation, we recommend that you run the software installer *before* you connect your MOTU interface to your computer and power it on. This ensures that all driver components are properly installed in your system.

RUN THE MOTU AVB AUDIO INSTALLER

To download the latest MOTU AVB audio installer, visit www.motu.com/avb. Follow the directions that the installer gives you.

MOTU AVB DISCOVERY APP

The MOTU AVB Discovery app is installed in your computer's applications folder; a shortcut is installed for it, too (as shown on page page 13). It locates all MOTU AVB interfaces connected to the computer, either directly through USB or on your network, and displays them in a list. Double-click an interface to access its settings through the web app ("MOTU AVB Control Web App" on page 13).

AUDIODESK WORKSTATION SOFTWARE

AudioDesk is an advanced workstation software package that lets you record, edit, mix, process, bounce and master multi-track digital audio recording projects. Advanced features include real-time effects processing, recording, and much more.

See the *AudioDesk User Guide*, available on your computer hard drive as a PDF document.

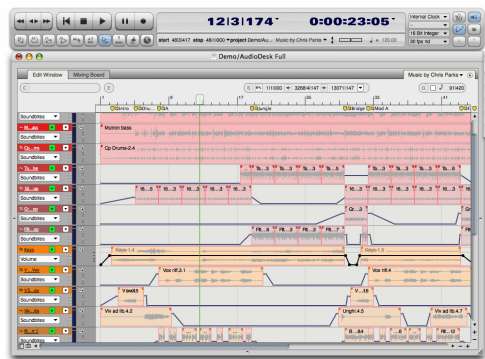

Figure 3-1: AudioDesk.

CHAPTER 4 Hardware Installation

OVERVIEW

Rack installation and heat	31
USB audio interface setup	36
Setup for two interfaces	32
Setup for three to five interfaces.....	33
Setup for a multi-switch network	34
Setup for multiple interfaces.....	35
Setup for web app control	36
A typical Monitor 8 setup	38
Audio connections.....	39
Syncing an AVB network.....	39

RACK INSTALLATION AND HEAT

When installing your MOTU audio interface in a 19-inch rack, leave extra space above, below, behind and on either side of the unit to provide adequate ventilation and heat dispersion. Do not install it near other gear that generates excessive heat.

USB AUDIO INTERFACE SETUP

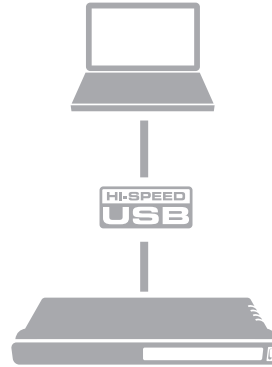

Use this setup if you want to use your MOTU device as a USB audio interface.

- Use a standard USB cable.
- Connect to any USB port (USB2.0 or 3.0).
- See “USB 2.0 class-compliant operation” on page 29.
- No driver installation is necessary.

AVB ETHERNET AUDIO INTERFACE SETUP

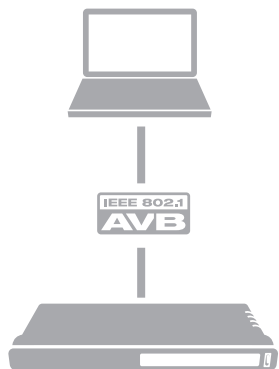

Use this setup if you want to use your MOTU device as an AVB Ethernet audio interface.

- Use a standard CAT-5e or CAT-6 cable.
- Connect to the computer's Ethernet port.
- See “Operation as an AVB Ethernet audio interface” on page 29.
- No driver installation is necessary.
- Make sure that at least one AVB input stream or one output stream is enabled (item #19 on page page 15).
- Launch the Mac's Audio MIDI Setup utility to enable the Monitor 8 and set the clock source and sample rate.
- The number of AVB audio channels that OS X can handle depends on the speed of your Mac.
- If applicable, see “Syncing multiple AVB audio interfaces connected to a Mac” on page 40.

About CAT-5e cables

Use shielded *CAT-5e* or *CAT-6* cables, which are a higher grade version of a standard Ethernet patch cable. They are available wherever network cables are sold.



SETUP FOR TWO INTERFACES

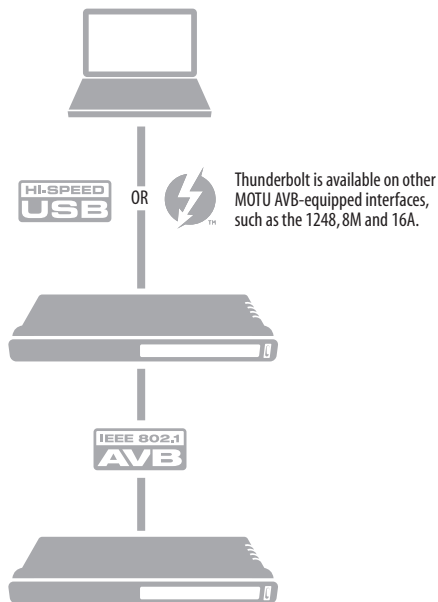

Use this setup if you want to connect two MOTU interfaces to your computer.

- The connection to the computer can be either USB or Thunderbolt, if you have a Thunderbolt-equipped MOTU AVB interface such as the 1248, 8M or 16A.
- Use a standard Thunderbolt cable. Place it at the end of the Thunderbolt chain.
- Use any standard CAT-5e Ethernet network cable to connect the two interfaces together using their NETWORK ports.
- As an alternative, see “Setup for multiple interfaces” on page 35.

SETUP FOR THREE TO FIVE INTERFACES

Use this setup if you want to connect three to five MOTU interfaces to your computer using a MOTU AVB Switch™ (sold separately).

- The connection to the computer can be USB or Thunderbolt (if you have a Thunderbolt-equipped MOTU AVB interface). Use Thunderbolt, if possible, to support a large number of audio streams to and from the networked interfaces. A single Thunderbolt connection supports 128 channels in and out, simultaneously. If you need more channels, and your computer has another available Thunderbolt or USB port, you can make a second connection, with full access to the network from both ports.

- Use standard CAT-5e Ethernet network cables to connect the interfaces to the MOTU AVB Switch using their NETWORK ports.

- Use the five AVB NETWORK ports on the switch (not the Ethernet port).

- Network cable lengths can be long: 100 meters with standard copper wire cables; much longer with fiber-optic network cables.

- See “About CAT-5e cables” on page 32.

- As an alternative, see “Setup for multiple interfaces” on page 35.

- To add more computers to the network, connect them to any interface, as shown. All computers and interfaces have full access to each other.

- See chapter 9, “Networking” (page 63).

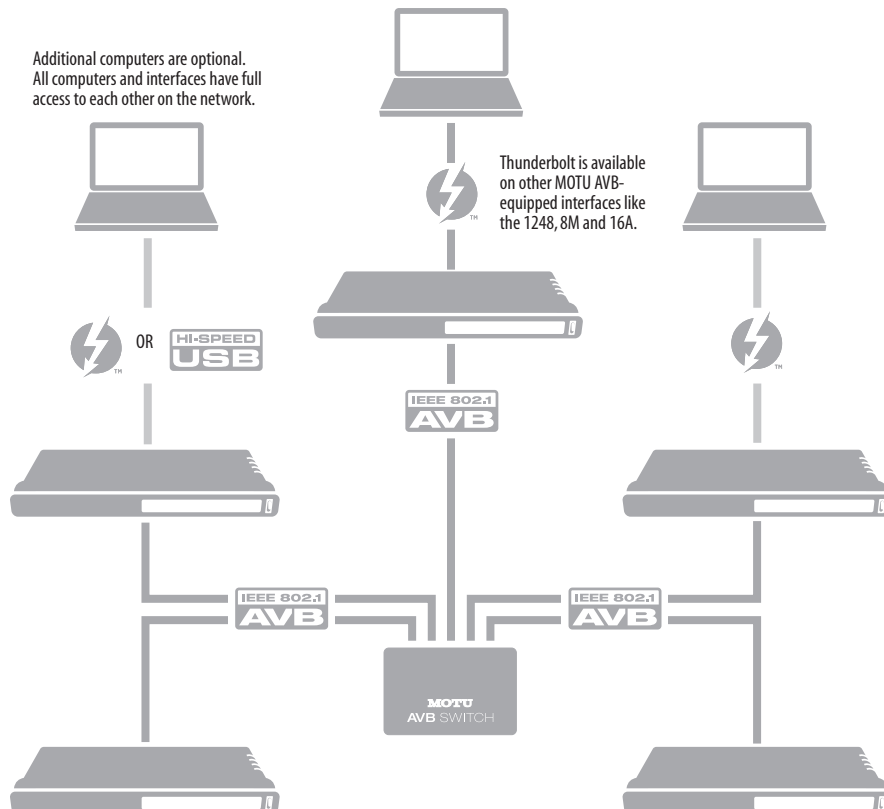

SETUP FOR A MULTI-SWITCH NETWORK

Use this setup if you want to connect more than five MOTU interfaces to an extended network that employs multiple AVB switches. AVB Ethernet is an industry standard, so you can use MOTU AVB Switches or 3rd-party AVB switches.

- You can daisy-chain switches in serial fashion, but don't create loops. For example, switches A, B, and C below are chained properly, but don't connect C back to A. Alternately, you could connect both Switches B and C to Switch A.

- For further information, see chapter 9, “Networking” (page 63).

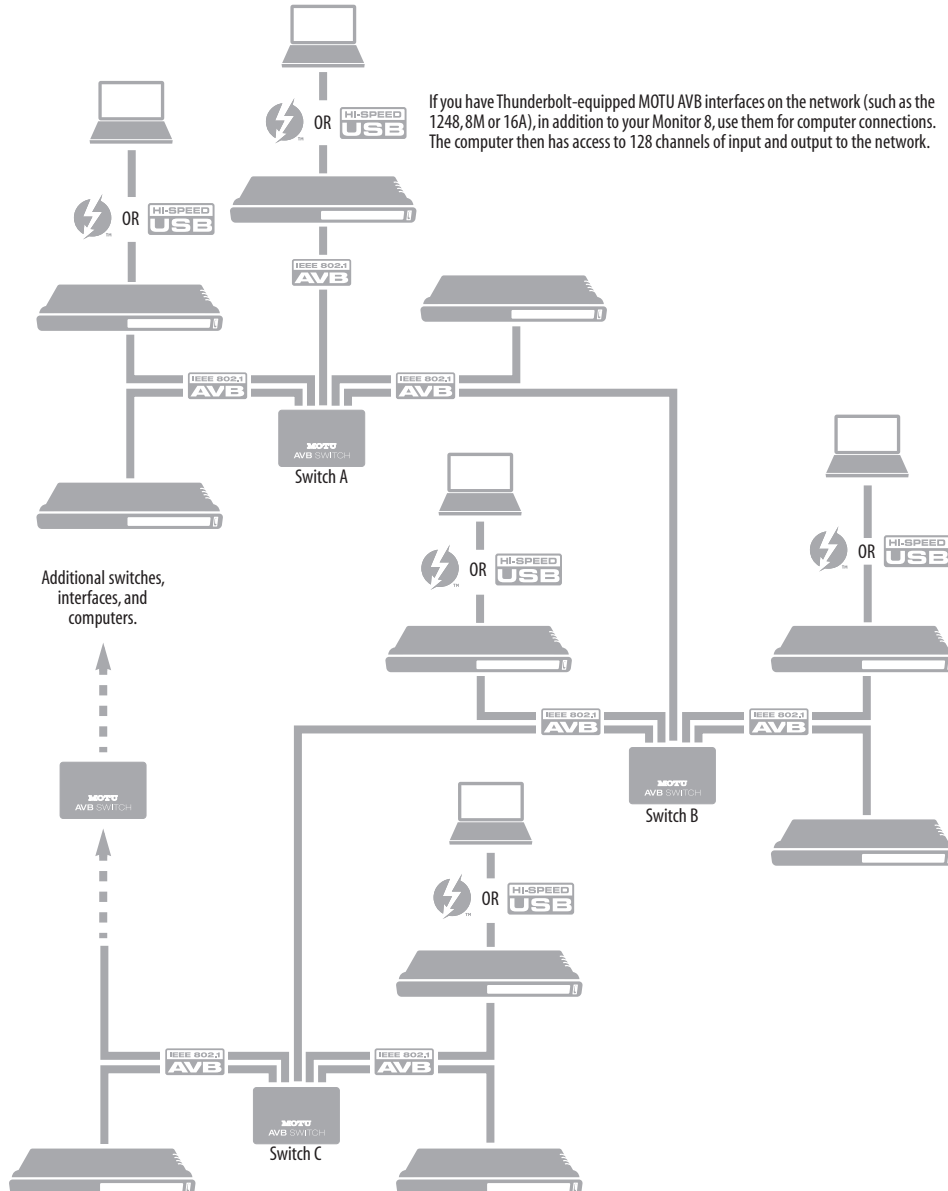

SETUP FOR MULTIPLE INTERFACES

It is possible to connect multiple MOTU interfaces directly to your host computer through multiple USB (and Thunderbolt) ports. Alternately, you can connect multiple interfaces, operating as AVB Ethernet audio interfaces, using an AVB switch connected directly to the Mac. However, there are several disadvantages to using any of these direct connection schemes:

- The audio interfaces will not be clocked to one another and may be susceptible to drift, unless you use external word clock connections (if available). You are better off using the AVB network connections shown on pages 32-34. In this setup, the interfaces are very tightly synchronized with each other (measured in pico seconds) through their network connections.
- You will not be able to route audio directly from one audio interface to another. You are better off using the AVB network connections shown on pages 32-34, which allows you to route audio streams (hundreds at a time) directly among interfaces with near-zero latency.

Connecting multiple interfaces using Thunderbolt

If you have other MOTU AVB interfaces with Thunderbolt connectivity (1248, 8M or 16A) and your host computer has two or more Thunderbolt ports, you can connect one interface to each port, either directly or at the end of a Thunderbolt daisy chain (on either port or both ports).

Connecting multiple interfaces using Thunderbolt and USB

Another way to operate multiple interfaces on the same host computer is to connect the first interface to a Thunderbolt port and the second to a USB 2.0 (or 3.0) port.

Multiple interfaces and USB

When connected through USB, your MOTU interface operates as a USB 2.0 device, even when connected to a USB 3.0 port. USB 2.0 provides enough bus speed for several USB 2.0 devices, but due to your MOTU interface's high-performance requirements for real-time operation and low latency timing, we recommend the following:

- Do not connect more than two units to your computer's USB 2.0 or 3.0 port(s).
- When two units are connected with USB 2.0, don't connect other USB 2.0 or 3.0 devices, such as external hard drives.
- For best results, establish clock synchronization with other interfaces connected to the same computer. You can use word clock, S/PDIF, ADAT, or AVB to achieve clock synchronization.

Multiple AVB Ethernet audio interfaces

When operating Monitor 8 as an AVB Ethernet audio interface ("AVB Ethernet audio interface setup" on page 32), multiple AVB audio interfaces can be connected using a MOTU AVB Switch (or any 3rd-party AVB switch), and the Mac can see all of them through their AVB connection. For example, you could connect an Avid S3 console to the Mac, and then connect a MOTU Monitor 8 to the S3's extra network port (which is a built-in switch). The Mac can see both Monitor 8 and S3 for audio I/O. However, OS X takes over each device for exclusive use, so they can only stream audio to and from the Mac, not each other. The same is true for all AVB devices connected to the Mac. See "Syncing multiple AVB audio interfaces connected to a Mac" on page 40.

Mixing and matching audio interfaces

In the scenarios just discussed for connecting multiple interfaces, you can mix and match the interface with other MOTU audio interface

models. For example, you could connect a 1248 through Thunderbolt and another MOTU audio interface, such as a Monitor 8, through USB 2.0.

SETUP FOR WEB APP CONTROL

The MOTU AVB Control web app gives you access to all settings, routing, mixing, and effects processing in your audio interface, and each interface on the AVB network, if applicable. For more info, see “MOTU AVB Control Web App” on page 13.

The web app is a web application served by the hardware. All you need to run it is a web browser running on a device that has a connection to your audio interface through USB or the network port.

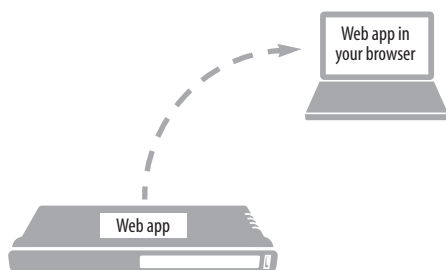

Figure 4-1: The web app is served from the hardware, and accessed through any web browser on any device connected to the interface.

Web app control can be set up independently of audio connections

The connections in this section, especially the network scenarios, can be set up independently of USB or AVB networking connections you make for audio routing (as shown in the setup diagrams earlier in this chapter). In addition, connections for web app control can be made over standard Ethernet and do not require AVB Ethernet connections. Think of web app control as being separate from audio. Doing so opens up a lot of possibilities for control of your MOTU interface, independent of the connections you make for audio.

Mixing and matching web app control scenarios

The web app connection scenarios shown in the following sections are not exclusive from one another. You can set up as many web app connections as you wish and control your MOTU device from many web app hosts simultaneously.

Launching the web app

Once you’ve made any of the connections shown in the following sections, launch the web app as explained in “Make hardware and network connections” on page 13.

Web app control over USB or Thunderbolt

If your audio interface is connected to a computer with internet access through USB (as shown on page 31), you can access the web app from the computer, or any other device on the network. In this case, make sure you’ve run the software installer (page 29), which installs drivers that allow your computer to properly communicate with the device.

Web app control through standard Ethernet

Your MOTU interface can also be controlled by the web app running on any device that has a standard Ethernet connection to the interface, either directly with a network cable, through an Ethernet hub, or through Wi-Fi on your local network. The sections on the opposite page show you how to set up each of these connection scenarios.

Ethernet cable

A simple Ethernet cable connection can be used for web app control, even without a USB or Thunderbolt connection to your computer. For example, if you are using your MOTU device as a mixer or audio router, you could control the on-board routing, mixing and effects from the web app through a standard Ethernet connection.

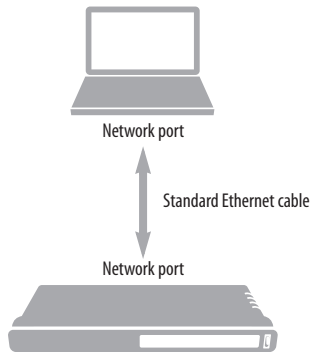

Figure 4-2: Web app control through a simple Ethernet cable.

Ethernet hub or network (LAN)

In this scenario, both your laptop and your MOTU device are connected to a standard Ethernet hub or home/office network (LAN). You can run the web app on multiple computers simultaneously.

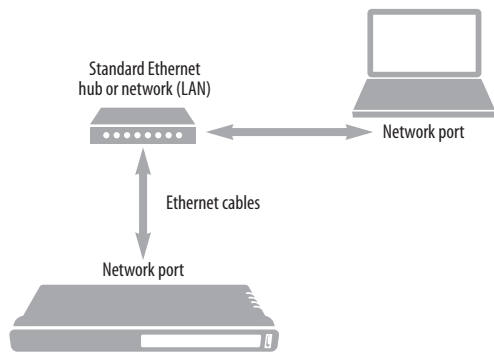

Figure 4-3: Web app control through a standard Ethernet hub or network (LAN).

Wi-Fi

When using standard Wi-Fi as shown, you can control your MOTU interface from multiple Wi-Fi devices simultaneously.

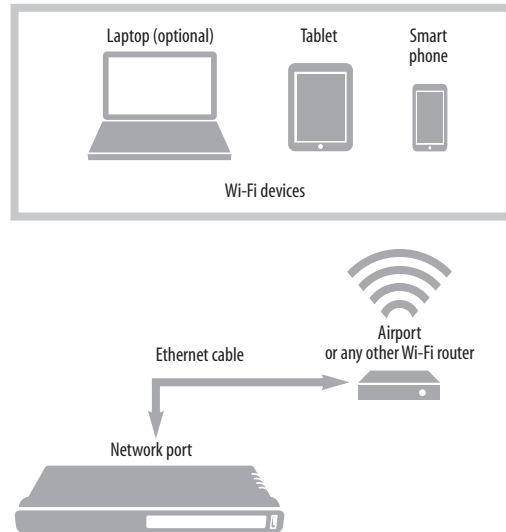

Figure 4-4: Web app control through Wi-Fi.

Ethernet network + Wi-Fi

You can, of course, combine the setups shown in Figure 4-3 and Figure 4-4, with Wi-Fi connected to the Ethernet hub or network.

MOTU AVB Switch

The MOTU AVB Switch provides five AVB Ethernet ports, plus one standard Ethernet port. Use the AVB ports for MOTU audio interfaces, and use the Ethernet port for Wi-Fi, Ethernet, etc.

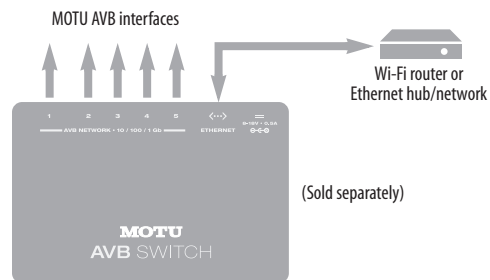

Figure 4-5: Using the Ethernet port on the MOTU AVB Switch.

A TYPICAL MONITOR 8 SETUP

Here is a typical Monitor 8 setup. This rig can be operated with or without a separate mixer. All mixing and effects processing can be done in the

Monitor 8 itself, controlled from your laptop, tablet, and smart phone — or several devices simultaneously.

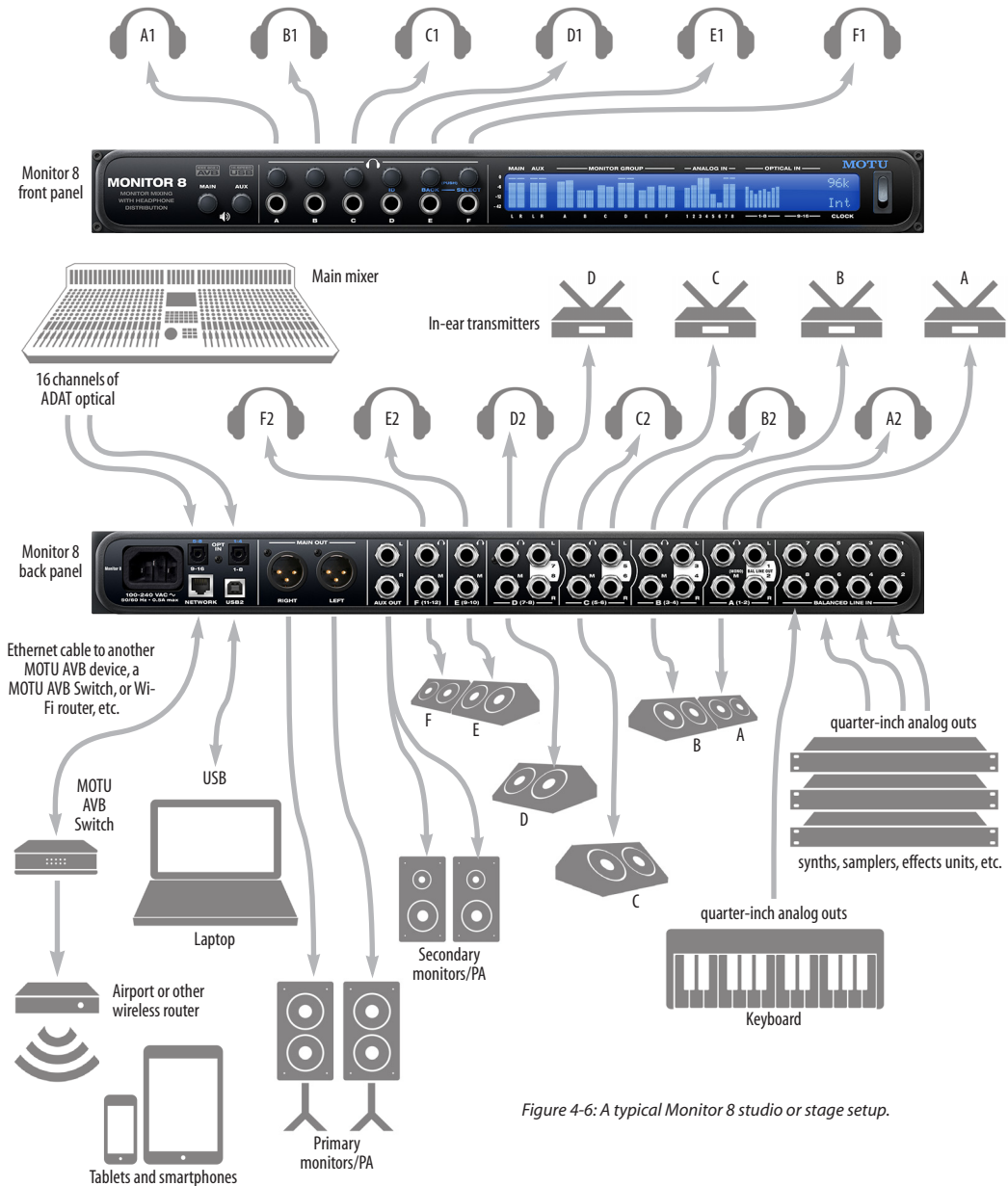

Figure 4-6: A typical Monitor 8 studio or stage setup.

AUDIO CONNECTIONS

Here are a few things to keep in mind as you are making audio connections to your Monitor 8 interface.

Analog trims

All quarter-inch analog inputs and outputs can be trimmed. This allows them to support a variety of standards, including EBU-R68, SMPTE RP-155, +4dBu, -10dBV, 2vRMS, 1vRMS.

Monitor 8 analog inputs are equipped with high-quality, digitally controlled analog trim that provides a range from -96 to +22 dB in 1dB steps.

Trim controls are most easily accessed in the web app. See “Device tab” on page 14. Trim settings can also be accessed in the LCD menu.

Optical

Monitor 8 provides two banks of ADAT optical (“lightpipe”) input. Together, they provide 16 channels of ADAT optical digital input at 44.1 or 48 kHz, or 8 channels at 88.2 or 96 kHz. The optical ports are disabled when the interface is operating at a 176.4 or 192 kHz.

Choosing a clock source for optical connections

When connecting an *optical* device, make sure that its digital audio clock is phase-locked (in sync with) your MOTU interface. Once the optical connection is made, choose the connected ADAT bank as the clock source (page 14). Be sure to choose the bank that the device is connected to.

SYNCING AN AVB NETWORK

The AVB protocol provides sophisticated and accurate timing, synchronization, and clocking features for AVB device networks of any size as shown on pages 33-34, including:

- Low latency
- Network-wide time base

- Better-than-sample-accurate phase lock across all connected devices
- Timing accuracy down to the nanosecond

Choosing a master clock

The Web app provides an easy way to choose one device as the master clock for your whole MOTU AVB network.

- 1 Go to the Devices tab (page 14).
- 2 In the device list (item #1 on page 14), choose the MOTU interface you wish to use as the clock master.
- 3 Click the *Become Clock Master* button below the Clock Mode menu.

Now, all other MOTU AVB devices on the network are resolved to this device.

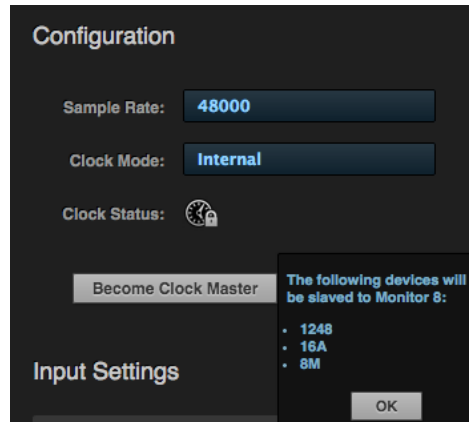

Figure 4-7: Choosing a clock master.

Alternately, you can go to the clock mode menu for each individual device separately and choose the master clock device by hand. For example, you may be in a situation where at least one MOTU device on the network must remain resolved to its own clock (or another clock source). Just know that in

this case, audio cannot be streamed between MOTU AVB devices that don't share the same master clock.

Resolving the master clock device to an external clock source

The MOTU device you've specified as the AVB network clock master can itself be resolved to an external time base such as word clock (if available) or ADAT optical. Just choose the desired clock source from its *Clock Mode* menu (in the Device tab). Doing so effectively resolves the entire AVB network to the external clock source.

SYNCING MULTIPLE AVB AUDIO INTERFACES CONNECTED TO A MAC

There are several options for clocking multiple AVB audio devices connected to the Mac:

- You can resolve them to an external clock source (like word clock, if available).
- You can choose *Mac: System Clock* as the clock source for each device (in the Audio MIDI Setup clock source menu).
- You can create an aggregate device, as usual. The aggregate device setup panel has a check box called *Drift Correction*, which sample-rate converts devices that are not synchronized.

Part 2

*Using your
MOTU interface*

CHAPTER 5 Presets

OVERVIEW

Because of its advanced, extensive feature set, your MOTU AVB interface can be used for many different purposes. This chapter discusses common use cases and their corresponding device presets, to help you use the hardware for your needs.

Preset menu

The preset menu (item #7 on page 14) contains a number of presets specifically designed for common use cases. By loading the corresponding preset, your MOTU AVB interface routing tab and mixer will be reconfigured accordingly. You can visit the Routing and mixing tabs to inspect settings and adjust them as needed.

Audio interface	43
Stand-alone mixer	44
Interface + mixer.....	44
Live recording with monitor mixing	45
Stage I/O.....	45
Stage I/O with mixing.....	45
Studio input expander.....	46
Studio output expander	46
Optical converter	46
Optical converter with mixing	46

Create your own presets

You can create presets to suit your specific needs. Your MOTU device is highly capable and configurable, allowing it to perform many tasks simultaneously.

Video tutorials

To view several excellent video tutorials for the presets described in this chapter, visit:

www.motu.com/avb

AUDIO INTERFACE

Choose the *Audio Interface* preset to use the Monitor 8 as a standard USB audio interface. Hardware inputs and outputs are accessible from your computer, and the mixer and audio networking features are disabled.



Figure 5-1: Using your MOTU AVB device as an audio interface.

STAND-ALONE MIXER

Choose the *Stand-alone* mixer preset to use Monitor 8 as a mixer. Doing so routes all physical inputs to the mixer, with the mixer's main mix bus and monitor bus going to the Main Out and Aux Out pairs. In addition, all inputs are fed to each Aux bus pair (1-2, 3-4, etc.), which are in turn routed to the six monitor groups A-F. This means that each aux bus can serve as its own independent monitor mix, with access to any/all inputs.

To control the mixer (with the AVB Control web app), you have several options. You can connect a computer to your MOTU AVB device using USB, Ethernet, or Wi-Fi, as explained in “Setup for web app control” on page 36. Figure 5-2 below shows the Wi-Fi scenario. Note that you can control the mix from multiple Wi-Fi devices.

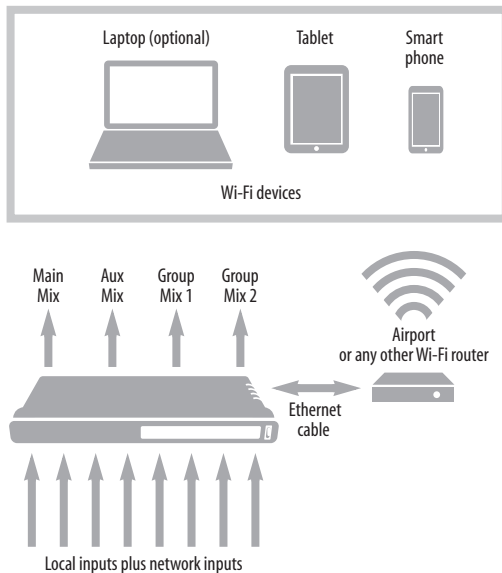

Figure 5-2: Using Monitor 8 as a stand-alone mixer. This example demonstrates how you can control the mixer from several Wi-Fi devices.

INTERFACE + MIXER

Choose the *Interface + Mixer* preset to use Monitor 8 as both an audio interface and mixer, simultaneously. Doing so routes all physical inputs and outputs to and from the computer, connected through USB or AVB Ethernet. In addition, the following audio sources are routed to the mixer, which mixes them to the Main Mix bus, plus six stereo aux busses for independent monitor mixes:

- The Monitor 8's eight analog inputs
- The Monitor 8's sixteen (or eight) ADAT inputs
- Eight USB channels from the host computer

The Monitor bus is set up as a solo bus.

In this scenario, you can control the mixer from the MOTU AVB Control web app running on the computer. You can also run the web app from wireless devices on the same Wi-Fi network as the laptop.

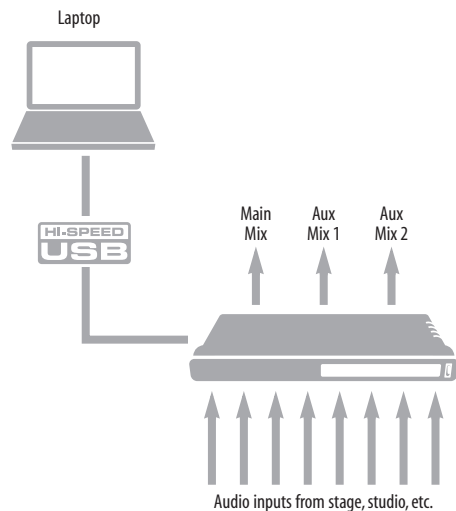

Figure 5-3: Using Monitor 8 as an audio interface and mixer, simultaneously.

LIVE RECORDING WITH MONITOR MIXING

Choose the *Live recording with monitor mixing* preset when you are tracking in the studio. The setup is pretty much the same as for the “Interface + mixer” preset shown in Figure 5-3 on page 44. All physical inputs on the interface are routed to both the computer (for recording) and the Main Mix and Monitor busses in the mixer (for near-zero latency monitoring). Eight USB channels from the computer are included in the Monitor 8’s mix. As with the other presets, six aux busses are routed to the Monitor 8’s six monitor group outputs, for independent monitor mixes.

STAGE I/O

Use the *Stage I/O* preset when you want to connect the inputs and outputs on the Monitor 8 to other devices over Ethernet cabling. This preset routes all inputs and outputs on the Monitor 8 interface to 8-channel AVB network streams in the routing grid, which are then broadcast to any/all other devices on the same AVB Ethernet network.

STAGE I/O WITH MIXING

The *Stage I/O with mixing* preset routes audio to and from other devices over Ethernet cabling. However, instead of routing incoming network audio directly to the Monitor 8’s outputs, this preset routes the incoming network audio to the mixer. The mixer then distributes eight separate mixes to the Monitor 8’s eight output groups (main, aux and monitor groups A-F).

For example, you could have a single Ethernet cable running from a Monitor 8 on stage to a 24Ai connected to the Front of House (FOH) mixer. You could then send 24 channels of FOH to the Monitor 8, which could then supply eight independent monitor mixes to musicians on stage.

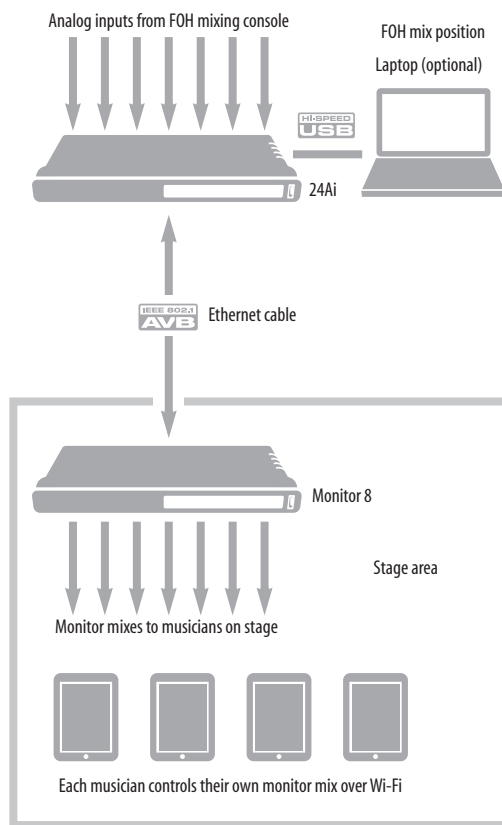

Figure 5-4: An example of using the *Stage I/O* preset: 24 channels from the FOH console are being distributed to musicians on stage as 8 separate monitor mixes. Monitor groups A-F supply multiple mirrored outputs to headphones, stage monitors, and in-ear transmitters.

STUDIO INPUT EXPANDER

Use the *Studio Input Expander* preset when you already have a main system set up, but you want to add additional inputs. This preset routes all physical inputs (analog and digital) on the Monitor 8 to AVB network streams. You can connect to the Monitor 8's network streams in the AVB Stream Connections section of the Device tab of the main MOTU AVB interface (item #20 on page 14).

STUDIO OUTPUT EXPANDER

Use the *Studio Output Expander* preset when you already have a main system set up, but you want to add additional outputs. This preset routes AVB network streams to all physical outputs (analog and digital) on the Monitor 8. You must then choose which network streams you wish to send to the Monitor 8's outputs. To do so, go to the AVB Stream Connections section of the Device tab for the Monitor 8 (item #20 on page 14).

OPTICAL CONVERTER

Choose the Optical converter preset if you would like the Monitor 8 to serve as a multi-channel digital-to-analog converter connected to another device equipped with an ADAT optical port.

For example, if you have another MOTU interface equipped with optical, you could connect its optical output banks to the Monitor 8's optical input banks. The Monitor 8 then serves as a 16-channel expander that adds all of the Monitor 8's analog outputs to your setup.

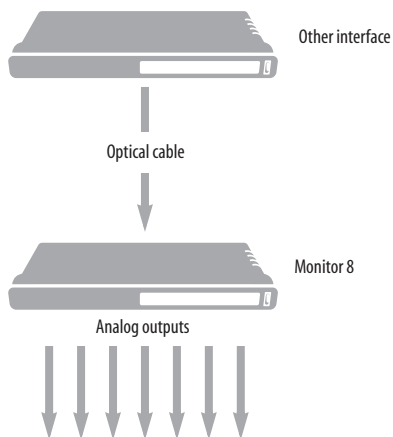

Figure 5-5: Use the *Optical converter* preset to use the Monitor 8 as an optical-to-analog expander.

OPTICAL CONVERTER WITH MIXING

The *Optical converter with mixing* preset does not route incoming optical audio directly to the Monitor 8's analog outputs. Instead, this preset routes the incoming optical audio to the mixer. The mixer then distributes eight separate mixes to the Monitor 8's eight output groups (main, aux and monitor groups A-F).

CHAPTER 6 The Front Panel LCD

OVERVIEW

The front panel LCD displays level meters for all inputs and outputs. The LCD also provides several navigable menus that provide status information and basic hardware settings.

- Level meters 47
- Push-button Knobs 47
- Channel focus 47
- ID 47
- Menu Navigation 47
- Device menu..... 48
- Network menu..... 48
- Settings menu 48
- Presets menu 48
- Version menu 48
- Clock..... 48
- ADAT SMUX Type 48
- Stand-alone operation..... 48

LEVEL METERS

In its default state when the unit is first powered on, the LCD displays level meter activity for all physical audio inputs and outputs on the device.

The meters display from -42dBFS to 0dBFS, as shown by the labels to the left of the LCD display (Figure 6-1).



Figure 6-1: V-Limit compressor on the 8M interface.

PUSH-BUTTON KNOBS

The front-panel knobs (Figure 6-2) are push-button digital rotary encoders. Push the knob for the function labeled in blue.



Figure 6-2: Push the knob to activate the functions labeled in blue.

Muting outputs

Push any knob to mute (and unmute) the output (or output group).

To mute or unmute Groups D, E or F (which have blue labels), turn the knob first and then push it while the LCD is focused on the output volume setting for the knob.

CHANNEL FOCUS

When turning a knob to adjust volume, the LCD shows the output volume setting. A few seconds after you stop turning the knob, the LCD returns to the previous display.

ID

Push ID (Figure 6-2) to immediately view the device’s network information, including its IP Address. Push BACK to return to the meters.

MENU NAVIGATION

Push SELECT to access the main menu, which provides settings and status information.

Main Menu

Turn the SELECT knob to scroll through the menu settings on the left side of the LCD.

Push SELECT to enter the selected sub-menu (column of options to the right) or to select the currently highlighted parameter.

Push BACK to go to the parent menu.

To exit the menu entirely, push BACK repeatedly until the menu disappears from the display.

Device menu

The Device menu provides information about the device, such as its name and connection mode (USB or AVB).

Network menu

The Network menu displays the following network-related information:

Setting	Explanation
Serial/UID	Unique AVB network identifier that can be used for troubleshooting.
IP address	The unique network address for the unit. Type this address into your web browser to access the unit's settings in the MOTU AVB Control web app.
AVB	Indicates whether AVB networking is currently enabled or disabled. For example, AVB could be disabled because a non-AVB switch is being used. When AVB is disabled, audio streaming over the network is disabled.

Settings menu

The Settings menu provides access to basic hardware settings, such as Clock Mode, Sample Rate, and so on.

Setting	What it does
Clock Mode	Sets the digital audio clock source for the device.
Sample Rate	Sets the sample rate for the device.
Optical	Specifies the SMUX format when operating at 88.2 or 96 kHz. See "ADAT SMUX Type" on page 48.
Configure IP	Chooses between DHCP and a manually assigned IP Address.
LCD Contrast	Adjusts the contrast of the LCD.
Factory Defaults	Restores factory default settings.

Presets menu

The Presets menu lets you recall settings that have been saved as a *device preset*. Use the web app to create and save presets (item #7 in the "Device tab" on page 14).

Version menu

The Version menu displays firmware version information.

CLOCK

The Clock section of the LCD displays the sample rate at which the unit is currently operating, and the current Clock Mode setting (item #13 in the Devices tab on page 14). The Clock Mode setting can also be found (and changed) in the Settings Menu.

ADAT SMUX TYPE

When your MOTU interface is operating at either 88.2 or 96 kHz, the *Settings menu > Optical* setting lets you configure ADAT SMUX type. There are two choices:

- Type I (standard) — for 3rd-party SMUX-compatible hardware products, including current-generation (and recent-generation) MOTU interfaces
- Type II — for older, legacy MOTU interfaces

STAND-ALONE OPERATION

All settings, including mix settings and device settings, are saved in your MOTU interface's memory. They remain in effect even when the interface is not connected to a computer. This allows you to use your MOTU device as a stand-alone mixer. You can make adjustments to any setting at any time from the web app running on a device that has a network connection to your MOTU interface, as explained in "Setup for web app control" on page 36.

CHAPTER 7 Working with Host Audio Software

OVERVIEW

Your MOTU interface provides multi-channel audio input and output for Core Audio compatible audio applications, including MOTU’s Digital Performer and AudioDesk, Apple’s Logic Pro and GarageBand, and other third-party software applications such as Ableton Live, Avid Pro Tools, Cockos Reaper, Propellerhead Reason and Record, Steinberg Cubase and Nuendo, PreSonus Studio One, Bitwig, and others.

AudioDesk is included with your MOTU system. For complete information about all of AudioDesk’s powerful workstation features, refer to the *AudioDesk User Guide.pdf* included in the AudioDesk application.

Digital Performer, MOTU’s state-of-the-art digital audio workstation software, is available separately; for details about upgrading from AudioDesk to Digital Performer, talk to your authorized MOTU dealer or visit MOTU.com.

Preparation	49
Run the web app.....	49
Choosing the MOTU AVB Audio driver.....	52
Reducing monitoring latency.....	53
Working with on-board mixing and effects	56

PREPARATION

Install your host audio software first if you haven’t already done so, and complete these chapters before proceeding:

- Chapter 4, “Software installation” (page 33)
- Chapter 5, “Hardware Installation” (page 35)

RUN THE WEB APP

Before you run your host audio software, launch the web app to configure your MOTU hardware.

The web app lets you configure important settings in your audio interface, enable the desired inputs and outputs, and set up audio streams to and from the computer.

Sample rate

Choose the desired sample rate for your interface and your host audio software. Newly recorded audio will have this sample rate.

Clock Mode

This setting is important because it determines the master digital audio clock for your system.

If you do not have any digital audio connections to your MOTU device (you are using the analog inputs and outputs only), and you will not be resolving your host software to optical or another external clock source, choose *Internal*.

If you have devices connected to the optical ports, see “Choosing a clock source for optical connections” on page 39.

Enabling and disabling input/output banks

In the web app Device tab (page 15), enable all input and output banks on your MOTU device that you wish to make available to your host audio software. Disable banks you are not using to simplify operation.

Specifying the number of computer channels

In the web app Device tab (page 15), in the *Computer Setup* section, specify the number of computer channels for streaming audio to and from your host audio software. You might want enough channels to cover the following:

- Physical inputs you want to record on your computer.
- The physical outputs you want to send audio playback to.
- Any audio streams going to and from the on-board mixer in your MOTU device.
- Any audio streams going to and from the AVB network, if you have multiple networked MOTU AVB devices.

If you aren't sure how many channels you'll need, visit the Routing tab, as explained below.

Making inputs and outputs available to your host software

In the web app, use the Routing tab (page 16) to map inputs and outputs to computer channels, as demonstrated in Figure 7-1 and Figure 7-2.

Configuration presets

The presets menu (item #7 in the Devices tab on page 14) provides many useful presets for various host routing scenarios. These presets are a convenient shortcut for the routing grid setups discussed in the next few sections.

Naming computer input and output channels

Click on any computer input or output name in the routing grid (Figure 7-1) to change its name. These names appear in your host audio software (if supported).

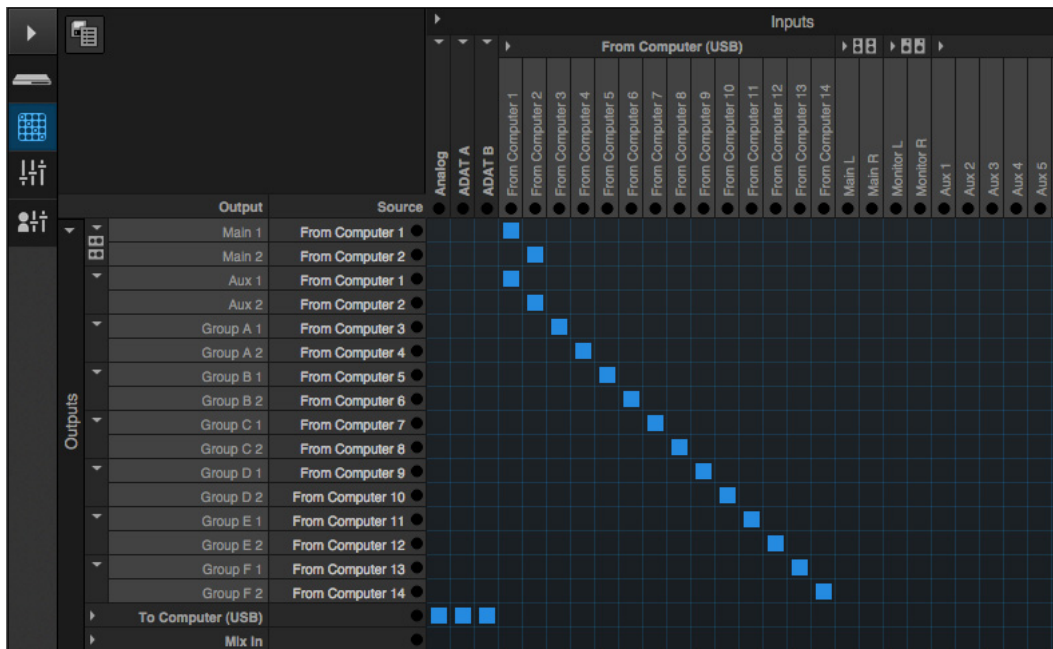

Figure 7-1: An example of routing computer channels (from host audio software) to the analog outputs on a Monitor 8. Computer channels 1-2 are being split to two pairs of outputs: Main 1-2 and Aux 1-2.

Streaming computer audio to and from the on-board mixer

In Figure 7-1, you'll see mixer inputs across the top of the grid (main, monitor, aux, etc.) These are output busses from your interface's on-board mixer. To route one of these mix busses to your host computer software, click the grid at the intersection of the mix column and desired computer channel row. Now, the mix bus output will be routed to the computer via the channel you selected.

Conversely, you can stream audio from the computer into the mixer. Channels coming from the computer are represented across the top of the routing grid as inputs. To route a computer channel to the mixer, click the grid at the intersection of the computer channel column and the desired mix input row. Now, that computer channel will be routed to the mixer input.

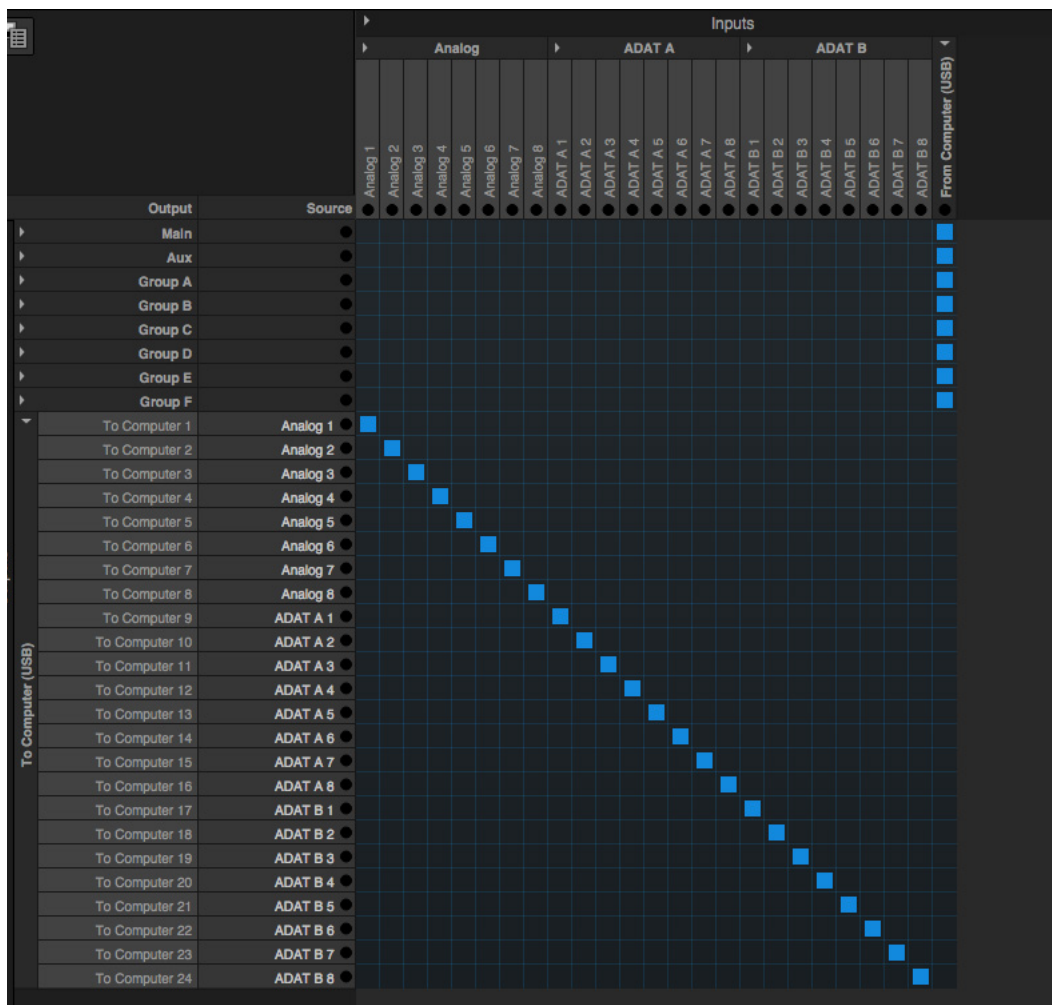

Figure 7-2: An example of routing physical inputs on the Monitor 8 to computer channels (for host audio software).

Working with AVB network streams

Audio channels going to networked AVB interfaces can be streamed to and from your host audio software through the MOTU interface connected directly to the computer. For information about how to set this up, see “Mapping computer channels to network streams” on page 67.

Mirroring computer channels to multiple outputs

Figure 7-1 shows an example of mirroring one stereo audio stream from host audio software to several outputs. In the example, computer channels 1-2 are being sent to Main 1-2 and Aux 1-2. To route an input to multiple outputs, click multiple boxes in its column, (see computer channels 1-2 in Figure 7-1).

Combining multiple inputs to one output

To merge (mix) any channels in the grid (computer streams or otherwise), route them to mixer inputs and then use the on-board mixer (“Mixing tab” on page 17).

Routing grid tutorials

For further information about using the routing grid, including many useful tips and techniques, visit:

www.motu.com/techsupport/technotes/avbrouting

and

www.motu.com/avb

CHOOSING THE MOTU AVB AUDIO DRIVER

Once you’ve made the preparations described so far in this chapter, you’re ready to run your audio software and enable the MOTU AVB audio driver.

Digital Performer and AudioDesk

In MOTU Digital Performer or AudioDesk, choose *Configure Audio System > Configure Hardware Driver* from the Setup menu. Choose *Monitor 8* (or other MOTU interface model) from the list of CoreAudio drivers.

Pro Tools

Go to the Setup menu and choose *Playback Engine*. Choose *Monitor 8* or other MOTU interface model) from the Current Engine menu. For information about the *H/W Buffer Size* setting, see “Reducing monitoring latency” on page 53.

🔊 Pro Tools 9 or later is required.

Logic Pro

Open the Preferences window, (click *Audio* tab -> *Devices* tab -> *Core Audio* tab). Choose *Monitor 8* (or other MOTU interface model) from the Output and Input device menus.

Garage Band

In Garage Band, go to the *Audio/MIDI* preferences (Garage Band drop-down menu -> Preferences -> *Audio/MIDI*) and choose *Monitor 8* (or other MOTU interface model) from the *Audio Output* and *Audio Input* menus.

Cubase and Nuendo

Open the *Device Setup* window. Click the *VST Audio System* item in the Devices list and choose *Monitor 8* (or other MOTU interface model) from the *VST Audio System* menu. Activate the inputs and outputs within Cubase or Nuendo as usual.

Live

Open the Preferences window and click the *Audio* tab. Choose *Core Audio* from the *Driver Type* menu. Choose *Monitor 8* (or other MOTU interface model) from the *Input Audio Device* and *Output Audio Device* menus. To enable or disable input or output channels, click the *Input Config* or *Output Config* buttons.

Reason and Record

Open the Preferences window, choose *Audio* preferences from the menu and choose *Monitor 8* (or other MOTU interface model) from the *Audio Output* menu.

Reaper

Open the Preferences window and click *Devices* under the *Audio* preferences. Choose *Monitor 8* (or other MOTU interface model) from the Audio Device menu.

Other audio software

Consult your software's manual for further information.

REDUCING MONITORING LATENCY

Monitoring latency is a slight delay caused by running an input signal through your host audio software and back out. For example, you might hear it when you drive a live guitar input signal through an amp modeling plug-in running in your audio sequencer.

This delay is caused by the amount of time it takes for audio to make the entire round trip through your computer, from when it first enters an input on your MOTU interface, passes through the interface hardware into the computer, through your host audio software, and then back out to an output.

Monitoring through your MOTU interface

If you don't need to process a live input with plug-ins, the easiest way to avoid monitoring latency is to disable your DAW's live monitoring feature and instead use the digital mixer in your MOTU interface to route the input directly to your outputs. For details, see "Mixing tab" on page 17. The mixer in your MOTU interface even provides zero latency effects processing (EQ, compression and reverb), which can be applied to the signal.

Direct hardware playthrough / Direct ASIO monitoring

When managing your live monitor mix through your MOTU interface mixer, remember to disable your DAW's live monitoring features, so that you won't hear record-enabled tracks in your DAW.

Also note that your MOTU AVB interface does not support *Direct Hardware Playthrough* in Digital Performer, or the *Direct ASIO Monitoring* feature (or similar) offered and other DAWs, which lets you control no-latency hardware monitoring from within the host application. Instead, you can use the MOTU AVB Control web app mixer ("Mixing tab" on page 17) to make these live monitoring connections manually.

If you don't require any effects processing on the input signal (no reverb or compression, for example), all this takes is one click in the routing grid to route the input being recorded to the output you are using for monitoring.

If you are recording a mono input that you'd like to monitor in stereo, or if you need to apply effects to the monitored signal, you can simply route the input to the mixer in your MOTU interface. This is done by opening the *Mix In* group in the *Outputs* column along the left side of the grid, and clicking the tile at the intersection of the input's column and the desired mixer input's row. Once routed to the mixer, use the input channel, reverb bus, and monitor bus in the mixer to apply effects as desired, and perhaps include other channels to the mix, and then assign the monitor bus output in the routing grid to the output you are using for monitoring.

In either case (routing directly in the grid or routing through the mixer), be sure to maintain the input's connection to the computer as well, so the input signal can be recorded in your host software. In other words, you'll want to make sure there are two tiles enabled in the input's column in the grid: one tile for the connection to the computer and another tile for your monitoring output (or a mixer input, if you are using the mixer to apply effects). If you need to route the input signal to other destinations, too, you can certainly do so (you can route the input to multiple destinations).

Monitoring through your host audio software

If you *do* need to process a live input with host software plug-ins, or if you are playing virtual instruments live through your MOTU audio hardware, you can significantly reduce latency by adjusting the audio buffer setting in your host audio software, as explained in the next section.

It is important to note that monitoring delay has no effect on the recording, or playback, of audio data from disk. The actual recording and playback is extremely precise, it is only the monitoring of your live input signal which may be delayed.

Adjusting your host software audio buffer

Buffers are small bundles of audio data. Your interface “speaks” to your computer in buffers, rather than one sample at a time. The size of these buffers determine how much delay you hear when monitoring live inputs through your audio software: larger buffers produce more delay; smaller buffers produce less.

Under Mac OS X, audio I/O buffer size is handled by the host audio application (not by your MOTU interface’s Core Audio driver). Most audio software applications provide an adjustable audio buffer setting that lets you control the amount of delay you’ll hear when monitoring live inputs or processing them with software plug-ins. Here are a few examples.

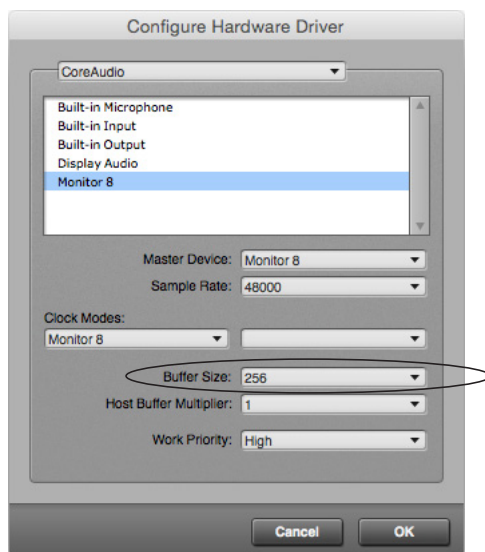

Figure 7-3: In Digital Performer and AudioDesk, choose Setup menu > Configure Audio System > Configure Hardware Driver to open the dialog shown above and access the Buffer Size setting. Refer to your Digital Performer or AudioDesk manual for information about the Host Buffer Multiplier setting.

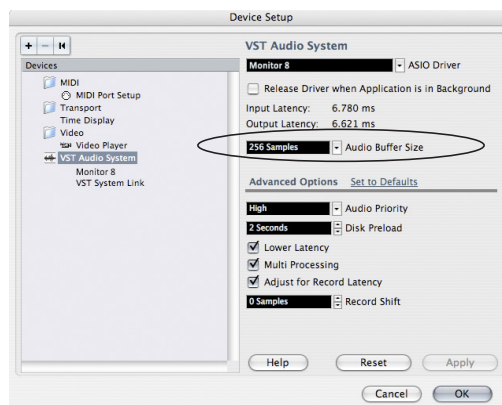

Figure 7-4: In Cubase or Nuendo, choose Devices menu > Device Setup. Select your interface (Monitor 8), then click the Control Panel button to access the window above and the Buffer Size setting.

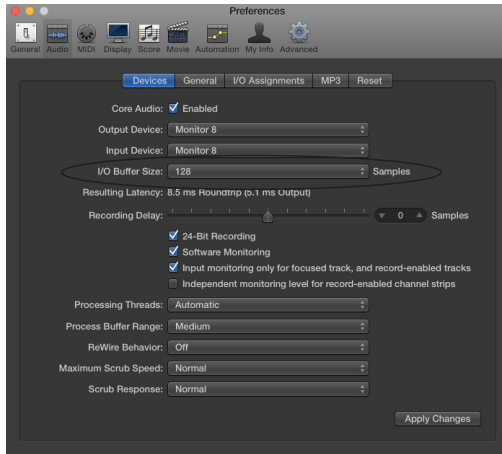

Figure 7-5: In Logic Pro, go to the Audio Driver preferences to access the Buffer Size option shown above.

Lower latency versus higher CPU overhead

Buffer size has a large impact on the following:

- Monitoring latency
- The load on your computer's CPU
- Responsiveness of transport controls and effect knobs in AudioDesk, Digital Performer or other audio software.
- Real-time virtual instrument latency.

The buffer setting presents you with a trade-off between the processing power of your computer and the delay of live audio as it is being patched through your software. If you reduce the size, you reduce monitoring latency, but significantly increase the overall processing load on your computer, leaving less CPU bandwidth for things like real-time effects processing. On the other hand, if you increase the buffer size, you reduce the load on your computer, freeing up bandwidth for effects, mixing and other real-time operations.

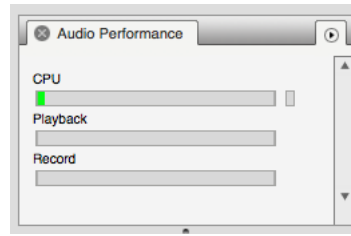

Figure 7-6: When adjusting the buffer size to reduce monitoring latency, watch the 'processor' meter in Digital Performer or AudioDesk's Performance Monitor. If you hear distortion, or if the Performance meter is peaking, try raising the buffer size.

If you are at a point in your recording project where you are not currently working with live, patched-thru material (e.g. you're not recording vocals), or if you have a way of externally processing inputs, choose a higher buffer size. Depending on your computer's CPU speed, you might find that settings in the middle work best (256 to 1024).

Transport responsiveness

Buffer size also impacts how quickly your audio software will respond when you begin playback, although not by amounts that are very noticeable. Lowering the buffer size will make your software respond faster; raising the buffer size will make it a little bit slower.

Effects processing and automated mixing

Reducing latency with the buffer size setting has another benefit: it lets you route live inputs through the real-time effects processing and mix automation of your audio software.

WORKING WITH ON-BOARD MIXING AND EFFECTS

Your MOTU interface provides powerful mixing, EQ, compression and reverb, which can operate hand-in-hand with your host's mixing environment. For example, your MOTU interface can serve as a monitor mixer, routing channels to musicians, or it can serve as an integrated extension of your host's mixing environment. You can even save a particular mixing configuration as a preset for future recall. For details, see "Mixing tab" on page 17.

CHAPTER 8 Mixer Effects

OVERVIEW

This chapter provides further information about the effects processors available in the DSP mixer in your MOTU AVB interface. For basic mixer operation, see:

- Mixing tab 17
- Aux Mixing tab 18
- Mixer input channel strips 19
- Main Mix and Monitor channel strips 20
- Aux bus channel strips 21
- Group and Reverb channel strips 22

Powerful DSP-driven mixing and effects

The mixer is driven by a powerful DSP that delivers 32-bit floating point precision and plenty of processing bandwidth for no-latency effects, including parametric EQ, dynamics, and reverb. Effects can be applied when operating as an audio interface or as a stand-alone mixer without a computer. Input signals to the computer can be recorded wet and/or dry, or recorded dry while a real-time wet monitor mix is sent to musicians. Effects include:

- High Pass Filter 57
A conventional high pass filter
- Gate..... 71
A standard gate with threshold/attack/release controls
- Four-band parametric EQ..... 58
Multi-band parametric EQ modeled after British analog consoles
- Compressor..... 59
A standard compressor with threshold/ratio/attack/release/gain controls

- Leveler 60
The Leveler™, an accurate model of the legendary LA-2A optical compressor, which provides vintage, musical automatic gain control

- Reverb 61
Classic reverb with tail lengths up to 60 seconds

Advantages over host-based mixing and processing

The hardware mixer in your MOTU AVB interface provides several major advantages over mixing and processing in your host audio software:

- No buffer latency. The DSP-mixer provides the same near-zero latency throughput performance as a conventional digital mixer. Effects processing doesn't impact your computer's CPU.
 - DSP mixing and routing can be maintained independently of individual software applications or projects.
 - DSP-driven mixing can function without the computer, allowing your MOTU AVB device to operate as a portable, stand-alone mixer with effects.
- ☛ Effects are disabled when operating at 4x sample rates (176.4 or 192 kHz).

HIGH PASS FILTER

All input channel strips provide a 12 dB per octave high pass filter. High Pass filters are often used to remove unwanted mic rumble, for example.

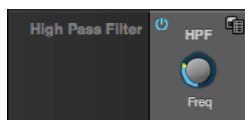

Figure 8-1: The High Pass Filter.

GATE

All input channel strips provide a Gate module.



Figure 8-2: The Gate module.

The gate silences the signal when the input signal's level drops below the *Threshold*.

The rate at which the gate responds, (opens to let signal through) is determined by the *Attack* parameter. With a short Attack time, the gate will open as soon as the signal crosses the Threshold; with longer Attack times, the gate will gradually open, much like a fade-in.

When the input level falls back below the Threshold, the time it takes for the gate to close (how quickly the signal is attenuated), is determined by the *Release* parameter. Short Release times will close the gate quickly, abruptly attenuating your signal, versus longer release times, which will gradually attenuate your signal, like a natural fade-out.

FOUR-BAND PARAMETRIC EQ

All mixer channel strips, (except for the Monitor bus), provide modeled, four-band parametric EQ.

Vintage EQ

Inspired by legendary British large console EQs, the *EQ section* (Figure 8-3) models the sound of the most sought-after classic equalizers. Four bands of center frequency parametric EQ filtering are provided, each with a bandwidth control. The High and Low bands include a shelf filtering option. With 32-bit floating point precision, the vintage EQ has been carefully crafted and meticulously engineered to produce musical results in a wide variety of applications.

Enabling EQ

Each band has an *enable/disable* button (Figure 8-3), allowing you to enable as few or as many bands as needed for the channel strip.

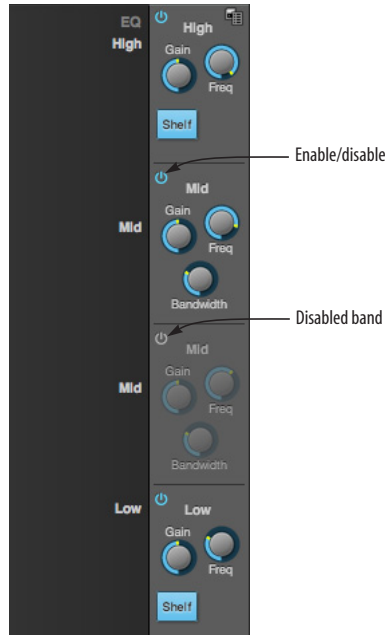

Figure 8-3: The Four-band parametric EQ module.

EQ filter controls

The EQ filters have three controls:

Control	unit	range
Gain	dB	-20.00 to +20.00
Frequency	Hertz	20 to 20,000
Bandwidth	Octaves	0.01 to 3.00

Double-click a knob to return to its default position.

EQ filter characteristics

EQ is one of the most widely used processing tools and can be applied to many different situations, from minor corrective tasks to creative tone sculpting. The four-band EQ has been designed to

be flexible enough to cover a broad range of applications. By adjusting Gain and Bandwidth together, you can emulate the smooth and musical character of classic analog EQ circuits, in which the Gain/Bandwidth dependency was dictated by the actual circuit design and electrical components used.

Low and high shelf filters

The Low and High bands offer a shelf option that is similar to those found in most conventional parametric EQs.

COMPRESSOR

All mixer input channel strips provide a compressor module.



Figure 8-4: The Compressor module.

The *Compressor* (Figure 8-4) lowers the level of the input when amplitude of the signal is above the Threshold. The amount of attenuation is determined by the *Ratio* and the input level. For example, if the input is 6 dB above the *Threshold* and the *Ratio* is 3:1, the compressor will attenuate the signal to 2 dB above the Threshold. When the input level goes above the threshold, the attenuation is added gradually to reduce distortion. The rate at which the attenuation is added is determined by the *Attack* parameter. Likewise, when the input level falls below the Threshold, the attenuation is removed gradually. The rate at which the attenuation is removed is determined by the *Release* parameter. Long Release times may cause the audio to drop out briefly when a soft passage

follows a loud passage. Short Release times may cause the attenuation to “pump”, a term used to describe the sound of the compressor when the average input level quickly fluctuates above and below the Threshold. These types of issues can be addressed by adjusting the compressor’s parameters, or applying the Leveler instead. *Gain* adjusts the overall output level of the compressor, post processing. The Level meter (Figure 8-4) shows the level of the input signal entering the compressor. It shows either the Peak envelope or the RMS level, if enabled.

Gain reduction meter

The Gain reduction meter (Figure 8-4) displays the current amount of attenuation applied by the compressor, before the makeup gain stage.

RMS mode

By default, the compressor operates in Peak mode, which uses signal peaks to determine the input level. In RMS mode, the compressor measures the input signal’s loudness, using the root-mean-square computational method. When RMS is disabled, RMS mode will let brief peaks through because the detector sidechain is only looking at the average signal level. By contrast, peak mode will catch those brief peaks. Peak mode is generally used for drums, percussion and other source material with strong transients, while RMS mode is mostly used for everything else.

The level meter shows either the peak level or the RMS level, depending on the mode.

LEVELER

The Leveler™ (Figure 8-5) provides an accurate model of the legendary Teletronix™ LA-2A® optical compressor, known for its unique and highly sought-after Automatic Gain Control (AGC) characteristics.



Figure 8-5: The Leveler module.

The Leveler is available on the Main Mix bus and all Group busses, including the Reverb bus.

A model of an optical compressor

An optical leveling amplifier works by shining a light on a photoresistor. The intensity of the light source is proportional to the audio signal, and the resistance of the photoresistor is in turn inversely proportional to the intensity of the light. Photoresistors respond quite quickly to increases in light intensity, yet return to their dark resistance very slowly. Thus, incorporation of the photoresistor into an attenuator followed by an amplifier which provides make-up gain produces a signal which maintains a constant overall loudness.

Automatic gain control using light

The AGC circuit of the LA-2A uses a vintage optocoupler known by its model number T4. The T4 contains an electroluminescent-panel (ELP) and photoresistor mounted so that the emission of the panel modulates the resistance. An ELP consists of a thin layer of phosphorescent material sandwiched between two insulated electrodes to

form a capacitor. Making one of the electrodes transparent allows the light to escape. These devices are essentially glow-in-the-dark paint on a piece of foil covered by metalized glass or plastic, and are the same devices used in low-power night lights. Unfortunately, these devices need high voltages to operate, and are best driven by tube circuits which can supply voltage swings of several hundred volts.

Response characteristics

Once the light has faded away, the photoresistor then decays back to its dark state. The shape of the decay curve varies depending on how bright the light was, and how long the light lasted. A general rule of thumb is that the louder the program, the slower the release. Typically, the release can take up to and over one minute. One thing to keep in mind when using these types of devices is that the typical concepts of compression ratio, attack, release, and threshold do not apply. The light intensity is determined by the highly non-linear interactions of the input signal, AGC circuit, and ELP, and thus exhibit a strong program dependence that is impossible to describe without the mind-numbing mathematics of statistical mechanics. The actual results, however, can be almost mystical: even when you feed the same material (a loop perhaps) through the Leveler twice, you'll often see a new response the second time through a loop, complete with unique attack times, release times and compression ratios. Furthermore, two different input signals with the same RMS levels may be leveled in a drastically different manner.

It is precisely this self-adjusting behavior that makes optical compressors the tool of choice for smoothing out vocals, bass guitar and full-program mixes without destroying perceived dynamics.

Enabling or disabling the Leveler

The Leveler models the LA-2A so closely, it also models the time it takes for an actual LA-2A to “warm up” after it is turned on. Therefore, when you enable the Leveler, give it a moment to “settle” before you begin processing signals with it.

Gain Reduction

Gain Reduction (Figure 8-5) sets the strength of the signal sent to the AGC model.

Makeup Gain

Makeup gain (Figure 8-5) amplifies the output signal to make up for gain reduction.

Limit button

The *Limit* button (Figure 8-5) models the original LA-2A Limit/Compress mode switch. The effect is very subtle, with the Limit option behaving only slightly more like a limiter than a compressor. The switch increases the level of the input to the AGC model and runs the attenuator at a slightly lower level. The Leveler then responds more strongly to transients, but otherwise still behaves like a leveling amplifier.

REVERB

Use the enable/disable button (Figure 8-6) to turn the reverb processor on or off. Since reverb uses considerable DSP resources, it is best to leave it off when you are not using it.



Figure 8-6: The Reverb processor.

Routing inputs and groups to the reverb processor

The reverb processor is a single, independent unit that provides stereo reverb. You can route any input channel or Group bus to the Reverb processor with the Reverb send on its channel strip. All incoming signals to the reverb processor are merged and processed together. The resulting stereo output from the reverb can then be merged into the Main Mix bus with the Main send on the Reverb channel strip (item #6 on page 22).

Reverb Time

Reverb time (Figure 8-6) determines the length of decay, or *tail*, of the reverb. The knob's range is from 100 milliseconds to 60 seconds.

Predelay

Predelay is the amount of time before the acoustic energy from the source returns to the listener, after reflecting off the surfaces of the listening space. The very first reflections helps you perceive information about the listening space, (size, distance, surface type, etc.). In large rooms, it takes a while (on the order of milliseconds) before the first reflections return to the listener. Predelay is useful for adding clarity, as it delays these reflections, before the onset of full reverberation. For example, with vocals, the reflections won't start until after the initial sound of a word has been sung.

Spread

Spread controls stereo imaging. A position of 12 o'clock produces essentially a mono image. Turning the control all the way to the left completely swaps the stereo image.

High and Mid frequency bands

The High and Mid frequency bands let you independently control the reverb time for separate frequency bands, relative to the low frequency reverb time. The *High* setting represents the bottom frequency of the High band; the *Mid*

setting represents the bottom frequency of the Mid band. The *Ratio* determines the length for each band specified in a percentage of the low frequency reverb time.

DSP USAGE

The DSP Usage meter (item #26 on page 19) shows how much of the available DSP processing power is currently being used by the mixer for the mix and for effects processing. If there aren't enough DSP resources for all effects to be enabled on a channel, effects are disabled for that channel and all subsequent channels.

☛ Unlike other effects, HPF and EQ on a stereo channel requires approximately twice the DSP resources as on a mono channel.

CHAPTER 9 Networking

OVERVIEW

The Audio Video Bridging (AVB) network port on your MOTU interface opens up a world of possibilities for creating expanded, customized audio network systems.

About AVB	63
MOTU's AVB implementation	64
Networking examples	64
A quick guide to networking	66
Setting up a MOTU AVB interface for networking....	67
Mapping audio to network streams	67
Mapping computer channels to network streams ...	67
Bridging to Ethernet	67
The MOTU AVB Switch	67

ABOUT AVB

Audio Video Bridging (AVB) is an extension of the Ethernet standard developed by the IEEE (802.1 standards committee) specifically to add high-performance audio and video networking. AVB brings together the worlds of networking technology and high-end audio. Here is a brief summary of some of the immediate benefits of AVB for you, as a MOTU AVB interface user:

- An open industry standard — AVB has been developed by the IEEE as an international standard specification. It is not proprietary or controlled by one company.
- High channel counts — AVB provides hundreds of network channels.
- Extremely low latency — AVB guarantees low-latency, real-time performance.
- Guaranteed Quality of Service (QoS) — AVB's Stream Reservation Protocol provides Guaranteed Quality of Service for each and every audio stream. If the network cannot continuously maintain every

bit of every sample in the audio stream, it will not allow you to make the network connection in the first place. AVB streams are prioritized over other network traffic to ensure high performance.

- Network-wide clocking and sync — AVB devices all clock together over your network for better-than-sample-accurate phase lock across all connected devices. Timing accuracy is down to the nanosecond.
- True plug-and-play operation — AVB has been designed from the ground up to provide automatic device discovery, enumeration, and connection management. Just plug your MOTU AVB interfaces into a standard AVB switch and go. If you wish to make stream connections and have the ability to select media clock, you must use the Web app, or some other AVB controller. You don't need an IT professional to configure the network. AVB is a self-managing network protocol.
- Bridging to standard Ethernet — AVB cooperates with standard Ethernet networks, for connecting traditional Ethernet devices like wireless routers, switches, or any other non-AVB-aware device.
- Support for existing network infrastructure — Replace your existing switches with standard AVB-compatible switches, and your CAT-5e or CAT-6 wired infrastructure now supports AVB.
- Long cable runs — a single AVB network connection can run up to 100 meters with a standard copper wire CAT-5e or CAT-6 cable. Fiber-optic cable runs can be much longer. With multiple switches, you can create a network that covers very large distances, if necessary. You can use up to seven “hops” (switch-to-switch connections).

- AVB is already shipping on current Macs — Apple supports AVB on all current shipping Macs, and your MOTU AVB interface can operate as a standard AVB audio interface when connected to your Mac's AVB-equipped Ethernet port.

MOTU'S AVB IMPLEMENTATION

MOTU engineering has faithfully implemented the IEEE 802.1 AVB standard for the MOTU AVB products. This means that MOTU devices are fully interoperable with any 3rd party AVB-compatible device. In addition, MOTU has fine-tuned AVB operation among MOTU AVB devices for optimum performance, within the AVB specification. Here is a brief summary of advantages you will enjoy when using MOTU AVB devices together in a network:

- 256 channels of host I/O — Over Thunderbolt or AVB Ethernet, each MOTU AVB interface support 256 simultaneous channels of audio I/O (128 in, 128 out) to and from the entire network.
- Support for multiple computer hosts — All computers and all network devices run in sync with each other, resolved to the network's master clock.
- Gigabit Ethernet — The MOTU AVB Switch delivers 1 Gbit Ethernet performance, which provides substantially higher bandwidth than 100 Mbit Ethernet. This allows you to have many more devices on the AVB network.
- Over 500 channels of network audio — MOTU's AVB network can stream over 500 channels of audio throughout the network. Depending on the model, some MOTU AVB devices can broadcast sixteen 8-channel network streams and simultaneously listen to sixteen 8-channel network streams.
- Exceptionally low network latency — Standard AVB network latency is 2 ms. MOTU AVB network latency is an astonishing 0.6 ms, even over seven

“hops” (switches) and hundreds of meters of cable. By comparison, other commercially available, proprietary audio network protocols have variable (unpredictable) network latency in the range of 2-5 ms.

- Star configuration — MOTU AVB supports a star network configuration, which is much more flexible than daisy-chain scenarios, which depends on all devices in the chain.
- Web interface — MOTU AVB devices can be controlled from the MOTU AVB Control Web App, which runs within any web browser on any networked laptop, tablet, or smart phone. Although the web app shares the network with AVB, AVB audio streams are never compromised because AVB streams over the network traffic.
- Bridging to standard Ethernet — the MOTU AVB Switch provides an extra standard Ethernet port for bridging to your local Ethernet network, Wi-Fi, etc. for command and control, internet access, and other standard network traffic. All ports allow connection to standard (non-AVB) network devices, however, the “Ethernet” port is suggested because it does not support AVB.

NETWORKING EXAMPLES

Networking comes into play as soon as you hook up a second MOTU interface to your first one, as explained in “Setup for two interfaces” on page 32, to add more I/O to your studio. Here are just a few examples of what is possible.

Personal studio expansion

Let's say you have a Monitor 8 mounted in a rack next to your computer. You could add an 8M interface and position it across the room, near your drum kit, for placing up to 8 mics on the drums. All the mic cabling is kept near the drums, and you have one simple, clean network cable running back to your computer system. Despite the distance, the two interfaces operate as a seamless system, controlled from your computer or iPad.

Studio installation

A studio installation of three to five interfaces can be handled with a single MOTU AVB Switch. See “Setup for three to five interfaces” on page 33.

Networking is ideal for studio installation because you can position interfaces at strategic locations. Running cables becomes much simpler and more cost effective. Not only does a setup like this give you access to all I/O from your computer, even multiple computers, you can also route audio from any input to any output across devices with near zero latency. You can also route audio from one computer to another with very low latency. As a simple example, you could deploy several interfaces in a studio as follows:

Interface	Location	Purpose
24Ao	Control room	Multi-channel output in control room for main monitors, secondary monitors, surround, etc.
1248	Iso booth	Local mic and instrument I/O in the iso booth.
Monitor 8	Studio room	Monitoring system for musicians.
8M	Studio room	More mic inputs, or additional mic inputs for drum kit
8M	Studio room drum kit	8 more mics on the drum kit
24Ai	Machine room	Analog inputs for hardware synths, outboard returns, etc.

Large studio facility

In a larger studio facility, you could build audio network neighborhoods similar to the studio installation described earlier in multiple rooms, even multiple floors, with multiple computers and Wi-Fi control from anywhere in the facility. All computers and devices can see each other and you can stream audio anywhere on the network with near-zero latency, as if any two devices were connected directly to each other.

Concert systems

Concert systems must be flexible so they can adapt to each new venue while on tour. Because of its modular nature, AVB networking allows you to design systems that are scalable and easy to adapt to each venue. You can easily bring devices on and offline, rerouting audio stems as needed.

Because MOTU AVB networking employs a star configuration, instead of daisy-chaining, you can set up backup computer playback systems on a shared network. For example, in a concert setting, if one computer system goes down, the backup system can be brought on line instantly through the same network infrastructure.

Traditionally, live performance setups often have separate domains for front of house mixing, monitor mixing, computer backline, and other systems. With MOTU AVB networking, these systems can be unified on the same network, opening up many possibilities for shared resources and mixing/routing responsibilities, especially from multiple sources (laptops, iPads, tablets, etc.) MOTU AVB networking handles audio in convenient 8-channel stems, making large-scale network management more manageable. MOTU AVB’s very low latency makes it particularly suitable for line arrays and sound reinforcement.

Large-scale venues

With long cable runs and industry standard networking infrastructure, MOTU AVB systems are well-suited for large-scale commercial installations such as arenas, stadiums, theme parks, clubs, casinos, houses of worship, broadcast facilities, schools, universities, and so on. Audio streams can travel long distances with sub-millisecond latency through as many as seven switches. Audio can be distributed from a centralized location to anywhere in the venue.

A QUICK GUIDE TO NETWORKING

MOTU AVB networking has been designed to be powerful, yet straightforward to set up and use. Here are a few things that are useful to know.

Networking basics

- Before proceeding below, review the networking connection diagrams on pages 32-34.
- To make network connections, use shielded CAT-5e or CAT-6 cables (a higher grade cable).
- Network cable lengths can be long: 100 meters with standard copper wire cables; much longer with fiber-optic network cables.

Working with AVB switches

- Networks of three or more interfaces require an AVB-compatible switch. You can use any standard AVB switch on the market. MOTU offers the five-port MOTU AVB Switch™ (sold separately).
- ☞ A non-AVB compatible switch will not work.
- Connect MOTU AVB interfaces to any AVB Switch using their NETWORK ports.
- On the MOTU AVB Switch, connect MOTU interfaces to the five AVB NETWORK ports (not the Ethernet port). Connect the Ethernet port to a Wi-Fi router, your Local Area Network (LAN) or your computer (for running web app only).

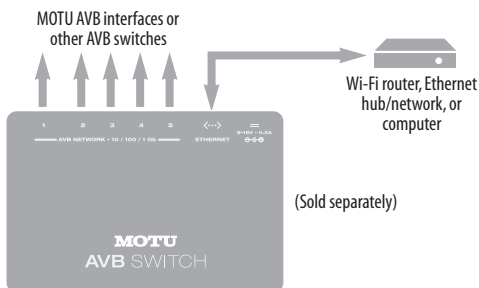

- Expand the network by adding more switches. Make a single connection from one switch to the other. On MOTU AVB Switches, use their AVB NETWORK ports, NOT the Ethernet port.

- You can daisy-chain switches in serial fashion, but don't create loops. For example, in the network below, do not make any additional connections between any two switches.

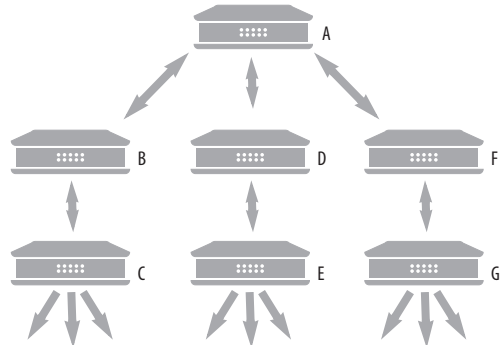

- AVB audio can't pass through more than seven switches. However, you can daisy-chain more than seven switches and route audio freely among them. You just won't be able to create point-to-point connects that span more than seven switches.

Working with computers on a network

- Computers are not required for network operation, as you can control the network from iPads, tablets and smart phones.
- To add computers to the network, connect them to any interface using Thunderbolt. If Thunderbolt is not available, use USB or AVB Ethernet.
- All computers and interfaces on the network have full access to each other.
- MOTU employs a 1 Gbit AVB implementation in the MOTU AVB Switch. The switch allows routing of many audio channels on the network.

SETTING UP A MOTU AVB INTERFACE FOR NETWORKING

Depending on the model, MOTU AVB interfaces have the ability to broadcast up to sixteen 8-channel streams to the rest of the network. Conversely, it can “listen” to as many as sixteen 8-channel streams from anywhere else in the network.

For each device on the network, set it up for network operation as follows:

- 1 In the MOTU AVB Control web app, choose the device (item #1 on page 14).
- 2 Go to the Device tab (item #5 on page 14), go to the *AVB Stream Setup* section (item #24 on page 15), and type in the number of 8-channel input and output streams you want for that device.
- 3 Go to the *AVB Stream Connections* section (item #10 on page 15), and choose the network stream you want the device to listen to for each bank.
- 4 Use the Routing tab to map specific I/O channels within each MOTU AVB interface to its network input and output streams, as explained in the next section.

MAPPING AUDIO TO NETWORK STREAMS

Once you’ve configured a device’s AVB streams, as explained above, use the Routing tab (page 16) to map audio channels to network input and output streams.

Input streams (coming from the rest of the network) are listed across the top of the routing grid. Expand the stream and click on the grid to map incoming network channels to local destinations, including physical outputs on the device, computer channels (to a connected computer), or mixer channels.

Output streams being broadcast to the rest of the network are listed in rows along the left side of the grid. Expand each stream bank and map individual network output channels to local sources, such as physical inputs on the interface, channels coming from the computer, or channels coming from the device’s mixer.

MAPPING COMPUTER CHANNELS TO NETWORK STREAMS

If a host computer is connected to an interface (through USB), mapping network input and output streams is accomplished as described in the previous two sections. Simply enable AVB streams as desired, and map them to computer channels in the Routing grid.

If, while mapping, you run out of computer channels, enable more in the *Computer Setup* section of the Device tab (item #21 on page 15). If the computer is connected with Thunderbolt, you can enable a maximum of 128 channels in and out. If the computer is connected with USB, performance will vary, depending on the sample rate and other factors.

BRIDGING TO ETHERNET

The Ethernet port on the MOTU AVB Switch allows you to connect standard network devices, such as:

- A Wi-Fi router
- An Ethernet hub or switch connected to a local home, studio, or office network
- Any other standard networking device

THE MOTU AVB SWITCH

The heart of a MOTU AVB network is the MOTU AVB Switch (sold separately). For a brief overview of the switch and its features, see “MOTU AVB Switch” on page 11.

Part 3

Appendices

APPENDIX A Troubleshooting

Some or all of my MOTU interface inputs and outputs are not available in my host audio software.

Make sure that the inputs and outputs are enabled in the Device tab (“Device tab” on page 14) and routed to and from the computer in the Routing tab (“Routing tab” on page 16). For details, see “Making inputs and outputs available to your host software” on page 50.

I have absolutely no audio input or output happening to or from my interface. Why?

Make sure that the unit has a stable sample rate (the sample rate will flash if the clock hasn’t settled yet). Try setting the unit’s clock source to *Internal* if you can’t sync to any external clock sources. Check that audio is working with Internal sync, and if so, then work on establishing a stable external clock.

I can't hear computer audio output through my MOTU AVB interface.

In the Sound panel of System Preferences, your MOTU AVB interface should be selected as the output device. Almost all applications will use just the first two output channels, so make sure that *From Computer 1* and *From Computer 2* are routed to the physical outputs that you are listening to in the Routing tab (e.g. Phones 1-2 or Analog 1-2).

How do I monitor live inputs?

Please refer to the documentation for the audio application that you are using. If your application does not support input monitoring, you will need to use the mixer in your MOTU interface. Please see “Monitoring through your MOTU interface” on page 53.

How do I control monitoring latency?

See “Reducing monitoring latency” on page 53.

The Routing tab (page 16) doesn't display some of the inputs or outputs on my interface.

The Routing tab only displays input and output banks that are enabled in the Device tab (page 14), so be sure any banks you wish to work with are enabled there. However, to conserve DSP resources and help consolidate screen-space in the other tabs, it is efficient practice to disable unused input or output banks (ADAT banks, for example, when only working with analog banks, or all output banks when only working with Phones).

I'm getting a "Could not enable this effect because DSP is overloaded" error. What should I do?

Disable other effects or reduce the number of mixer inputs to conserve DSP resources. If there are audio input and output banks on your interface that you are not using (such as the ADAT optical banks), disable them in the Device tab (page 14).

I accidentally deleted my factory presets. How do I restore them?

In the Device tab (page 14), click the *Restore Factory Presets* button to restore all factory presets.

How do I factory reset my device?

Push the SELECT knob/button to enter the main menu. Navigate to *Settings > Factory Default* and push the SELECT knob/button twice to reset.

Clicks and pops due to hard drive problems...

If you have checked your clock settings and you are still getting clicks and pops in your audio, you may have a drive related problem. Set your Clock Source to *Internal* and try recording just using the analog inputs and outputs on your MOTU interface. If you encounter the same artifacts you may want try using another drive in your computer. Clicks and pops can also occur when the drive is severely fragmented or there are other drive-related issues.

Connecting or powering gear during operation...

It is not recommended that you connect/disconnect, or power on/off devices connected to your MOTU interface while recording or playing back audio. Doing so may cause a brief glitch in the audio.

CUSTOMER SUPPORT

We are happy to provide complimentary customer support to our registered users. If you haven't already done so, please take a moment to register online at MOTU.com, or fill out and mail the included registration card. Doing so entitles you to technical support and notices about new products and software updates.

TECHNICAL SUPPORT

If you are unable, with your dealer's help, to solve problems you encounter with your MOTU device, you may contact our technical support department in one of the following ways:

- Tech support hotline: (617) 576-3066 (Monday through Friday, 9 a.m. to 6 p.m. EST)
- Online support: www.motu.com/support

Please provide the following information to help us solve your problem as quickly as possible:

- The serial number of your MOTU device. This is printed on a label placed on the bottom of the rack unit. You must be able to supply this number to receive technical support.
- A brief explanation of the problem, including the exact sequence of actions which cause it, and the contents of any error messages which appear on the screen.
- The pages in the manual that refer to the features or operation of your MOTU AVB Device or AudioDesk with which you are having trouble.
- The version of your computer's operating system.

We're not able to solve every problem immediately, but a quick call to us may yield a suggestion for a problem which you might otherwise spend hours trying to track down.

If you have features or ideas you would like to see implemented, we'd like to hear from you. Please write to the Development Team, MOTU Inc., 1280 Massachusetts Avenue, Cambridge, MA 02138, or use our online suggestion box at www.motu.com/suggestions.

APPENDIX B Audio Specifications

Line Out

Connector Type	1/4" Female, TRS XLR 1/4" Female, TS	Balanced, tip hot Pin 2 hot Summed mono
Output Impedance	100 ohm	Per leg
Dynamic Range	123 dB	A-weighted
THD+N	-110 dB (0.0003%)	-1 dBFS, Unweighted, 1 kHz
Frequency Response	+0, -0.1 dB, 20 Hz/20 kHz	Ref. 1 kHz
Max Level Out	+22 dBu	
Trim Range	128 dB	-127 to 0 dB in 1 dB steps

Line In

Connector Type	1/4" Female, TRS	Balanced/unbalanced, Tip hot
Specification	Complies with EBU-R68 / SMPTE RP-155	
Impedance Load	10 k ohm	
Dynamic Range	110 dB	A-weighted
THD+N	-104 dB	-1 dBFS, Unweighted
Frequency Response	+0, -0.1 dB, 20 Hz/20 kHz	Ref. 1 kHz
Max Level In	+24 dBu	
Trim Range	118 dB	-96 to +22 dB in 1 dB steps

Phones

Connector Type	1/4" Female, TRS Stereo	Tip Left, Ring Right
Dynamic Range	108 dB	A-Weighted
THD+N	-100 dB	Unweighted
Frequency Response	+0 -0.15 dB, 22 Hz/20 kHz	Ref. 1 kHz
Drive	Max. 80 mw	16/32/55 ohms
Trim Range	128 dB	-127 to 0 dB (muted) in 1 dB steps

Power Supply

Connector Type	IEC 3-conductor receptacle	For AC mains connection
Configuration	Internal, Universal	
Power Input	100 V to 240 V, 50 Hz or 60 Hz	
Power Usage	35 watts	

APPENDIX C Mixer Schematics

MONO INPUT CHANNEL

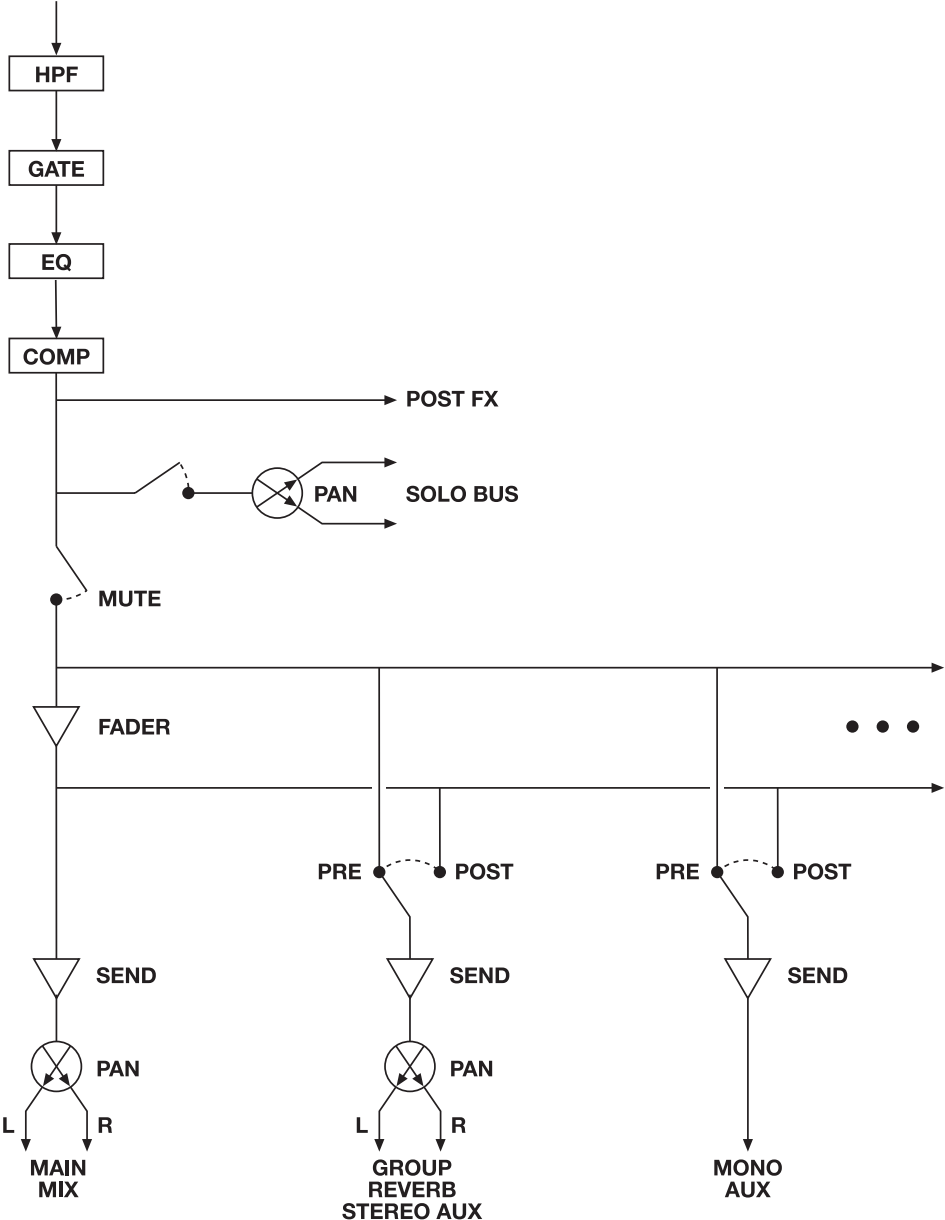

STEREO INPUT CHANNEL

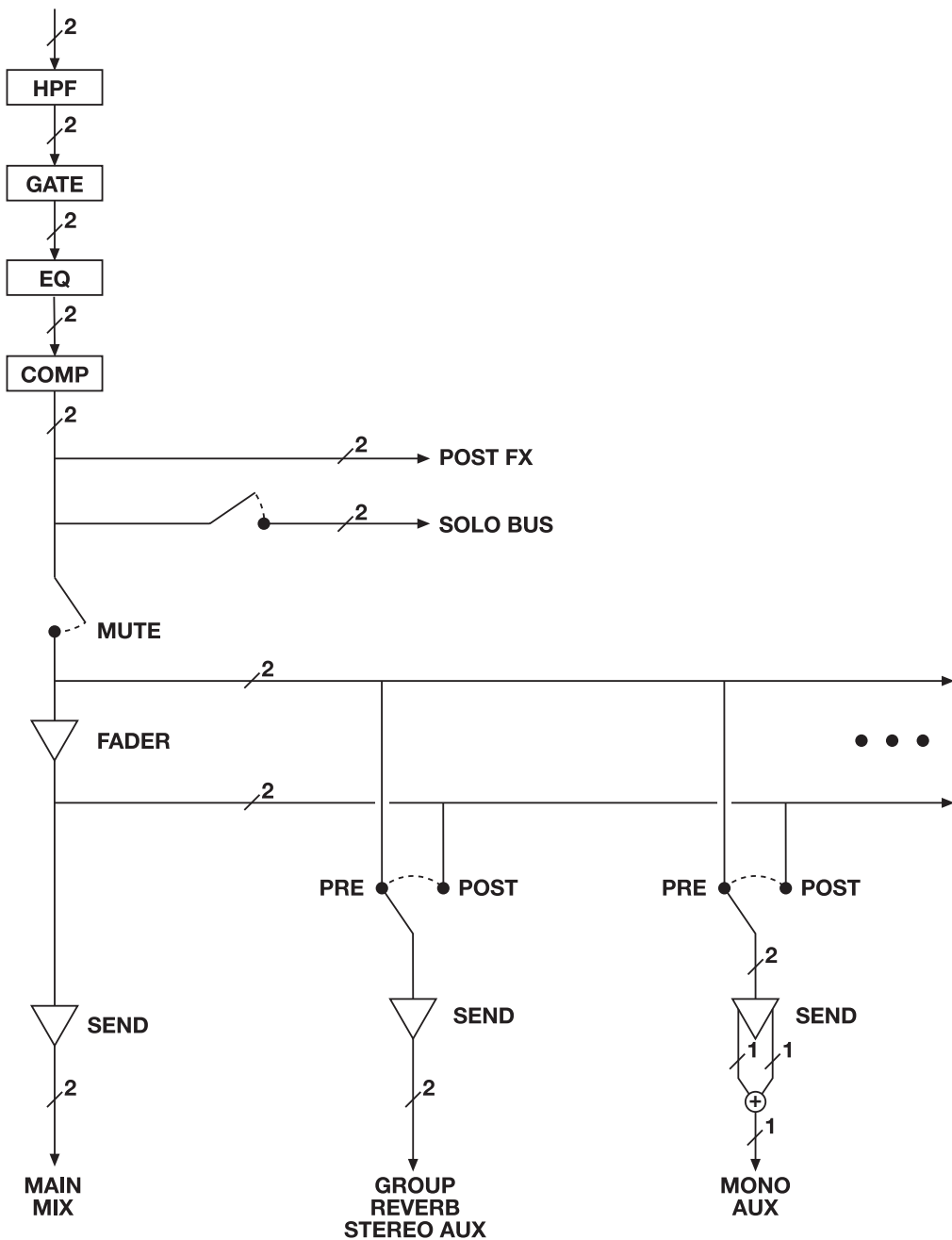

GROUP BUS

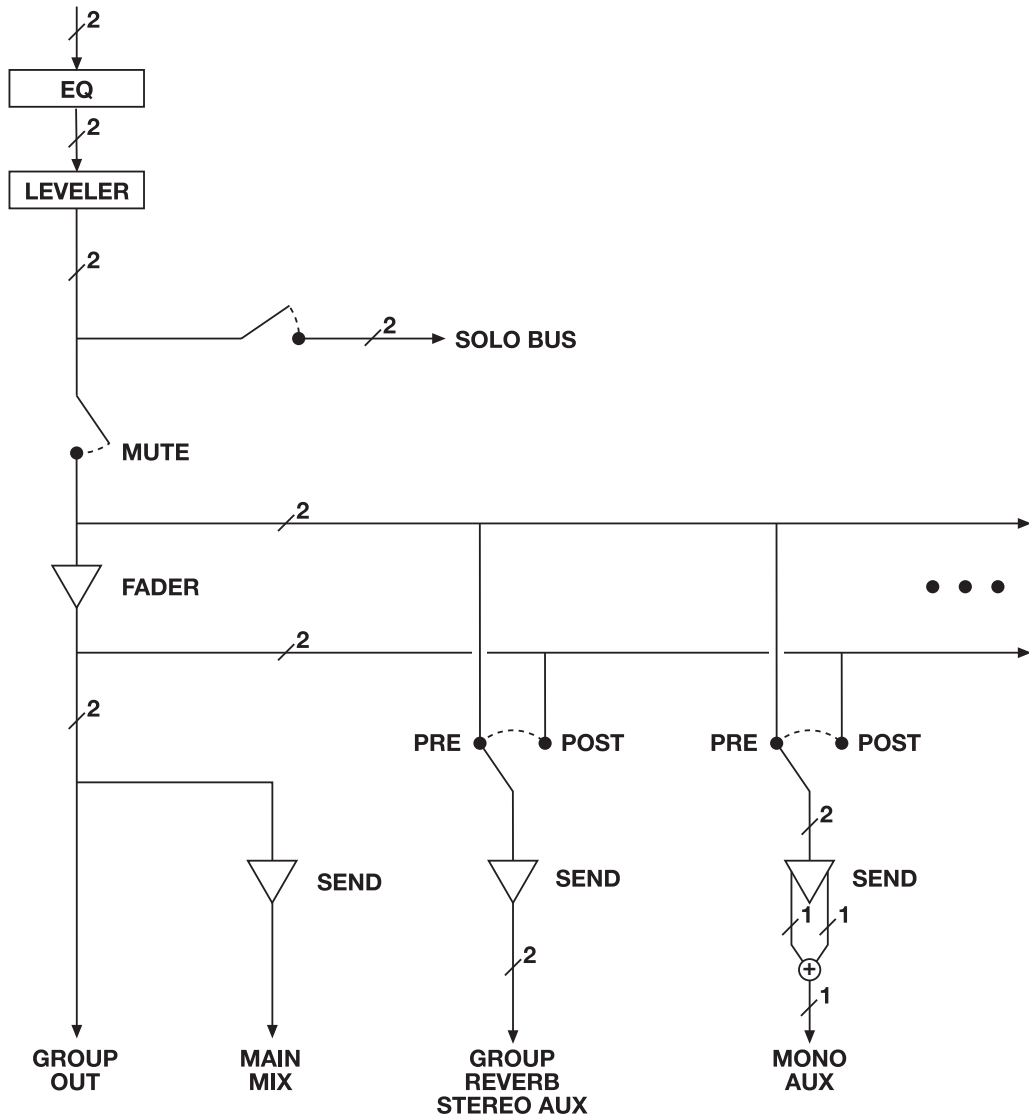

MONITOR BUS

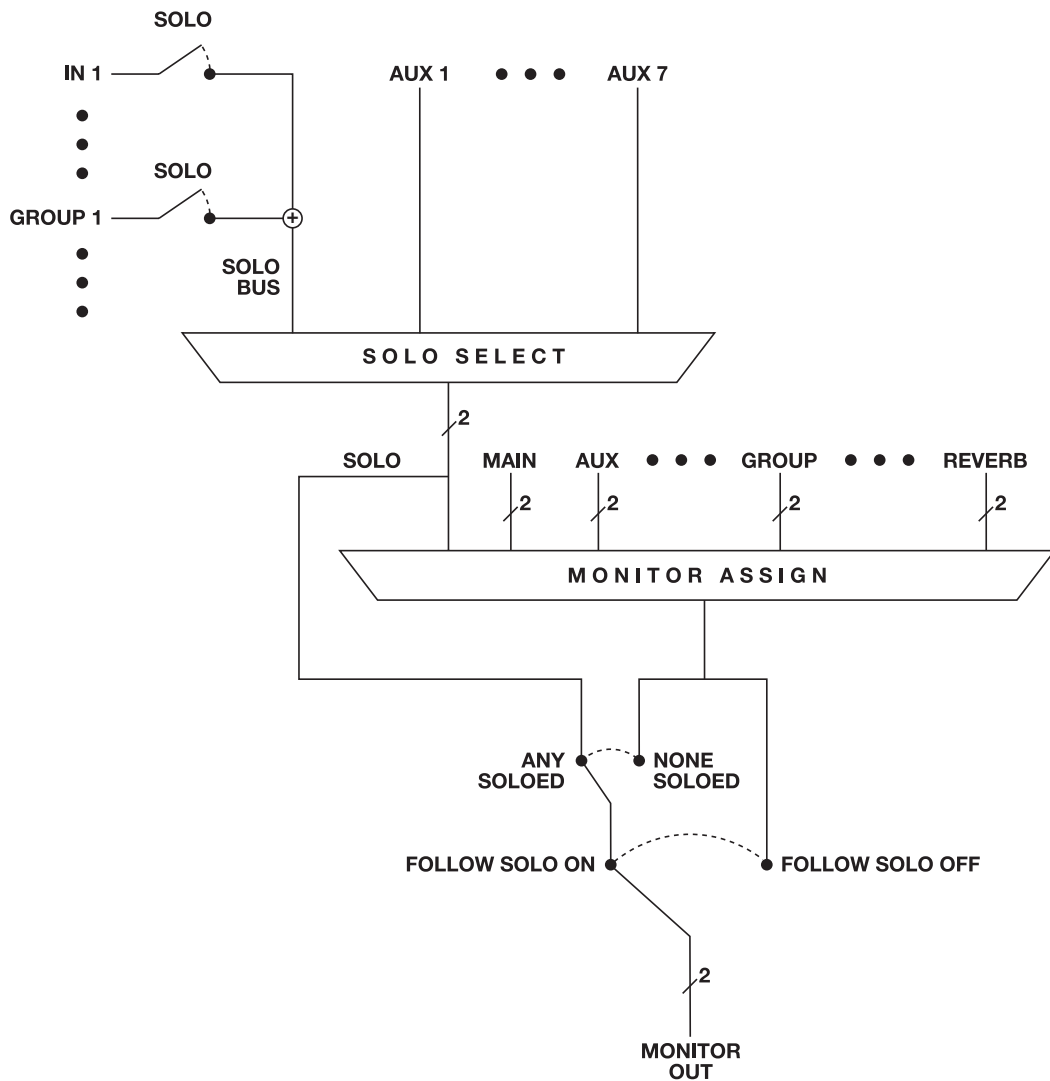

APPENDIX D **Updating Firmware**

MOTU periodically posts firmware updates for your MOTU AVB interface. These updates may include bug fixes, enhancements, and new features.

Updates are posted on MOTU's servers. If your computer or Wi-Fi device has access to the internet, the MOTU AVB Control app notifies you as soon as an update is made available. Otherwise, you can check motu.com/avb periodically for the latest firmware update.

A network cable connection is required

Firmware updating requires a network cable connection, so before you begin, connect a standard CAT-5 or CAT-6 network cable from the network port on your MOTU interface to one of the following:

- Your computer's network port (or a Thunderbolt-to-Ethernet adapter)
- Your home, studio, or office network (with internet access)
- An AVB port on a MOTU AVB switch (connected to your office network through the Ethernet port)

Updating with internet access

You are now ready to update:

- 1** Launch the MOTU AVB Control web app on your computer, iPad, or iPhone, as usual.
- 2** Go to the Device tab.
- 3** In the *New Update Available* banner (Figure D-1), click *More Info*.
- 4** After reviewing the list of enhancements, click OK to start the update.
- 5** Wait a few moments for the update to finish, then click OK to return to the Device tab.

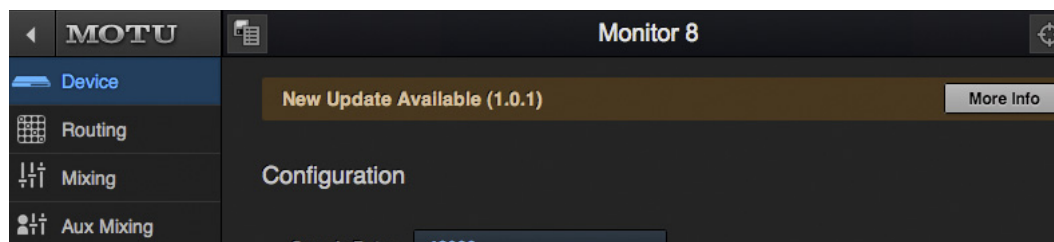

Figure D-1: The firmware update banner appears automatically at the top of the Device tab when your web host has internet access and MOTU posts an update.

Updating off-line, without internet access

If your MOTU AVB interface (and the computer it is connected to) has no internet access, you can download a firmware update file from another computer that does have internet, and then use the file to update your MOTU interface, as follows:

- 1 Download the firmware file.
- 2 Transfer the file to a computer with a network cable connection to your MOTU interface.
- 3 Launch the MOTU AVB Control web app on the computer, as usual.
- 4 Go to the Device tab.
- 5 Scroll down to the bottom and click *Update from File*.
- 6 Locate the file on your hard drive and click OK to start the update.
- 7 Wait a few moments for the update to finish, then click OK to return to the Device tab.

Viewing the latest firmware version information

You can confirm the firmware version at the bottom of the Device tab (Figure D-2).

Why does the firmware update require a network cable?

Firmware updating was designed to use ethernet mostly for convenience. If you have lots of networked devices, you can upgrade them all from a distance (even over Wi-Fi) without having to plug in directly and without having to download or run an updater application.

This approach was also taken for engineering reasons, with reliability foremost in mind. When installing an update, the device reboots into a stripped-down recovery partition to guarantee that the update process can always be completed, even if the power goes out mid-update. Since updates can also affect the Thunderbolt or USB chips, they cannot be used during the update.

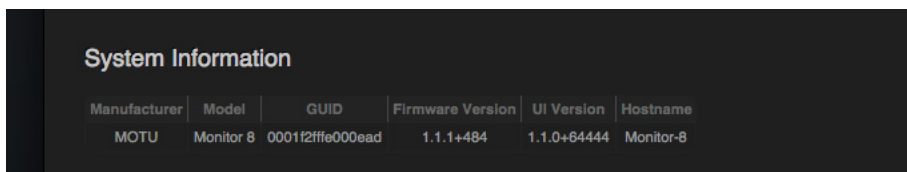

Manufacturer	Model	GUID	Firmware Version	UI Version	Hostname
MOTU	Monitor 8	0001f2ffe000ead	1.1.1+484	1.1.0+64444	Monitor-8

Figure D-2: The currently installed firmware version is displayed at the bottom of the Device tab.

APPENDIX E **OSC Support**

Open Sound Control (OSC) is a protocol for communication among computers and other multimedia devices that is optimized for modern networking technology.

MOTU AVB audio interfaces support OSC, which provides remote control of all device settings and mixer controls from any OSC-enabled controller.

For further details about remote control through OSC, along with complete documentation for the MOTU AVB OSC API, visit:

<http://www.motu.com/avb#avb-osc-support>

24-bit
optical 10

A

Ableton Live 49
ADAT optical 10
SMUX Type 48
Analog inputs/outputs 39
Apple
Garage Band 52
ASIO monitoring 53
Attack
Compressor 58, 59
Audio interface preset 7, 43
AudioDesk 25, 30, 49, 52
authenticating 71
Aux Mix Target 18
Aux Mixing tab 18
AVB
Discovery app 7, 30
Ethernet explained 63
Input/Output Banks 15
networking 63-67
overview 63
Stream Connections 15
Stream Setup 15
streams (Routing tab) 16
Switch
setup 33, 37
AVB Control web app 7, 13-22
Aux Mixing tab 18
Device tab 14, 15
Mixing tab 17
Routing tab 16
AVB Switch 11

AVB Control web app 7, 13-22
Aux Mixing tab 18
Device tab 14, 15
Mixing tab 17
Routing tab 16
AVB Switch 11

B

Become Clock Master 14, 39

C

CAT-5e/6 cables 11, 32
Check for Updates 15
Chrome 13
Class compliance 29
Clock section (LCD) 48
Clock source 14
Cockos Reaper 53
Compressor effect 17, 59
Computer Setup 15
Connecting multiple interfaces 32
Control surface support (through OSC) 81
Converter mode
setup/example 46
Converters 10
Cubase 49
clock source 49
Mac OS X 52
sample rate 49
Customer
support 72

D

Device tab 14, 15
Digital converter (see Optical converter)

Digital Performer 49, 52
Direct hardware playthrough 53
Direct ASIO monitoring 53
Direct hardware playthrough 53
Driver installation 7, 13, 29
Drivers
installing USB drivers 30

DSP
effects 57
meter 62
resources 62
DSP Usage 19, 62

E

Effects 57
EQ 58
enabling 58
filter types 58
frequency 58
gain 58
Q 58
Ethernet
connecting 37
Ethernet cables 11
Expansion 32

F

Firefox 13
Firmware updates 14
Follow Solo 17, 20
Four-band EQ 58
Frequency
EQ 58
From Computer 16
Front panel 47
menu navigation 47
metering 47

G

Gain
EQ 58
reduction 59
reduction (Leveler) 61
Garage Band 49, 52
clock source 49
sample rate 49
Gate effect 17, 58
GR (gain reduction) 59

H

Headphones
connecting 38
High pass filter 57

I

ID knob/button 13, 14, 47
IEEE 802.1 63
Input banks 15
Input Settings 14
Inputs
optical 10
Installation
hardware 31
network 33, 34

QuickStart Guide 7
software 30
Thunderbolt interface 31, 32
two interfaces networked 32

Interface + mixer preset 7, 44
Internet Explorer 13
IP address 13
iPad

QuickStart 7

L

Latency 53, 55
LCD
menu 47
Leveler 17, 60
Lightpipe
2x mode 48
Limit button 61
Live recording with monitor mixing preset
7, 45
Logic Pro/Express 49
clock source 49
sample rate 49

M

Mac OS X 49
input and output names 50
Makeup gain 61
Mixer
accessing 17
aux bus 21
connecting 38
effects 57
group bus 22
input channel strip 19
main mix channel strip 20
Monitor channel strip 20
overview 17
Reverb bus 22
schematics 75
Setup 15
stand-alone operation 57
Mixing tab 17
Monitor 8
expansion 32
installing 31
setup example 38
specifications 73
summary of features 23

MOTU

AudioDesk 52
AVB
Switch 11
AVB Control web app 7, 13-22
Aux Mixing tab 18
Device tab 14, 15
Mixing tab 17
Routing tab 16
AVB Discovery app 7, 30
AVB Installer 7, 13, 29
AVB Switch
setup 33, 37
Digital Performer 52

N

- Networking 63-67
 - installation 33, 34
 - MOTU AVB Switch 11
- Nuendo 49
 - clock source 49
 - Mac OS X 52
 - sample rate 49

O

- Optical
 - 2x mode 48
 - connectors 10
- Optical converter mode 48
- Optical Converter preset 7, 46
- Optical converter preset
 - setup/example 46
- Optical converter with mixing preset 46
- Optimization 55
- OS X audio software
 - clock source 49
 - sample rate 49
- OSC support 81
- Output banks 15
- Output settings 14
- Outputs
 - optical 10

P

- Packing list 27
- Patch thru
 - latency 55
- Performance 55
- PRE switch 17
- PreDelay 61
- Prefader button 18
- Presets 7, 14
 - Mixer tab 17
 - overview 43
 - Routing tab 16
- Pro Tools 49
- Processing 57

Q

- Q 58
- Quick Setup window 7
- QuickStart Guide 7

R

- Ratio
 - Compressor 59
- Reaper 49, 53
- Reason 49
- Record 49
- Registration 27
- Release
 - Compressor 58, 59
- Remote control (through OSC) 81
- Restore Factory Presets 15
- Reverb 61-62
 - design section 61
 - enabling/disabling 61
 - predelay 61
 - routing to/from 61
 - time 61, 62
 - width 62
- RMS mode 59
- Routing tab 16

S

- S/MUX 48
- S/PDIF
 - optical 10
- Safari 13
- Sample rate 14
- Samplers
 - connecting 38
- SC button 20
- Schematics 75
- Software
 - installation 30
- Software installer 7, 13, 29
- Solo bus 20
- Solo Clear button 19
- Soundtrack Pro

- clock source 49
- sample rate 49

- Stage I/O preset 7, 45
- Stage I/O with mixing preset 45
- Stage monitors
 - connecting 38
- Stand-alone mixer preset 7, 44
- Stand-alone operation 47, 48
- Studio Input Expander preset 7, 46
- Studio Output Expander preset 7, 46
- Studio setup (example) 38
- Synchronization
 - Become Clock Master 39
- Synths
 - connecting 38
- System requirements
 - minimum 27
 - recommended computer 27

T

- Technical support 72
- Threshold
 - Compressor 59
- To Computer 16
- TOSLink 10
- Troubleshooting 71
- TRS analog inputs/outputs 39
- Type I, II optical mode 48

U

- Update From File 15
- USB
 - class compliance 29
 - installing drivers 30

V

- View Personal Mix 18

W

- Width
 - reverb 62
- Wi-Fi
 - setup 37