

iConnectAUDIO²⁺_{TM}

Owner's Manual



Interference with other electrical devices Radios and televisions placed nearby may experience reception interference. Operate this unit at a suitable distance from radios and televisions.

Indoor use only To avoid the risk of electrocution and/or damage to other connected equipment, this equipment must not be used under wet or high moisture conditions. All interconnecting cabling must also be indoors. Should moisture suddenly increase, immediately disconnect power to the equipment.

Power sources Ensure that correctly rated power outlets are used with the supplied power supply.

Heat Keep this equipment away from all heat sources. Ensure that sufficient ventilation and/or heat dissipation is provided for the equipment and all connected devices.

Packaging Keep all packaging materials away from children. Properly dispose of unwanted packaging.

Handling To avoid breakage, do not apply excessive force to the switches, connectors or directly to the equipment. Do not apply excessive bending force to the cables. Use the connector casings of cables to attach and detach cables from their receptacles to avoid damage to the cable and/or its receptacles.

Ingestion Do not ingest the packaging, equipment, attachments, or accessories. Do not ingest paint or removed parts from the equipment or accessories. If this occurs, immediately seek medical attention.

Care If the exterior becomes dirty, wipe with a clean, dry cloth. Do not use liquid cleaners such as benzene or thinner, or cleaning compounds or flammable polishes.

Keeping foreign matter out of your equipment Never set any container with liquid in it near this equipment. If liquid gets into the equipment, it could cause electrical damage, breakdown, fire, or electrical shock. Be careful not to let metal objects get into the equipment.

Keep this manual After reading this manual, please save it for later reference.

Notice regarding disposal (EU only) Disposal of this product, package, or cables must be done in an approved manner. Do not discard this product, package, or cables along with ordinary household waste. Disposing in the correct manner will prevent harm to human health and potential damage to the environment. Since the correct method of disposal will depend on the applicable laws and regulations in your locality, please contact your local administrative body for details.

FCC (USA)/IC (Canada) Regulation Warning

This equipment has been tested and found to comply with the limits for a Class B digital device, pursuant to Part 15 of the FCC Rules. These limits are designed to provide reasonable protection against harmful interference in a residential installation. This equipment generates, uses, and can radiate radio frequency energy and, if not installed and used in accordance with the instructions, may cause harmful interference to radio communications. However, there is no guarantee that interference will not occur in a particular installation. If this equipment does cause harmful interference to radio or television reception, which can be determined by turning the equipment off and on, the user is encouraged to try to correct the interference by one or more of the following measures:

- Adjust the receiving antenna
- Increase the separation between the equipment and receiver
- Connect the equipment into an outlet on a circuit different from that to which the receiver is connected
- Consult the dealer or an experienced radio/TV technician for assistance

Unauthorized changes or modifications to this system can void the user's authority to operate this equipment.

Important notice to consumers

This product has been manufactured according to strict specifications and voltage requirements that are applicable in the country in which it is intended that this product should be used. If you have purchased this product via the Internet, through mail order, and/or via a telephone sale, you must verify that this product is intended for use in the country in which you reside.

WARNING

Use of this product in any country other than that for which it is intended could be dangerous and could invalidate the manufacturer's or distributor's warranty. Please also retain your receipt as proof of purchase; otherwise, your product may be disqualified from the manufacturer's or distributor's warranty.

CAUTION

Always keep children and pets under constant adult supervision. The packaging, equipment, and included accessories are not toys and must be kept out of reach of children and pets. Use only under constant adult supervision.

Warranty

iConnectivity warrants to the original purchaser that this unit is free of defects in materials and workmanship under normal use and maintenance for a period of one (1) year from the date of original purchase. The warranty applies only to registered iConnectivity users that register their product(s) within fourteen (14) days of time of original purchase. To register iConnectivity products, visit iConnectivity.com. If the unit qualifies for warranty service during the one (1) year period, it will be repaired, or replaced, at iConnectivity's option, at no charge, when returned prepaid to the iConnectivity Technical Service Center with proof of purchase – the sales receipt may be used for this purpose. Installation labor is not covered under this warranty.

All replacement parts, whether new or re-manufactured, assume as their warranty period for only the remaining time of this warranty. This warranty does not apply to damage caused by improper use, accident, abuse, improper voltage service, fire, flood, lightning, or other acts of God, or if the product was altered or repaired by anyone other than iConnectivity Technical Service Center. Consequential and incidental damages are not recoverable under this warranty.

Some regions do not allow the exclusion or limitation of incidental or consequential damages, so the above limitation or exclusion may not apply. This warranty gives you specific legal rights, and you may also have other rights, which vary from state to state. No portion of this warranty may be copied or duplicated without the expressed written permission of iConnectivity. THIS WARRANTY IS NOT TRANSFERRABLE.

For warranty service please [contact iConnectivity](#).

Compatibility

Please visit www.iConnectivity.com/support for the latest compatibility requirements, as they are subject to change.



iPad, iPhone, and iPod touch are trademarks of Apple Inc., registered in the US and other countries.

"Made for iPod," "Made for iPhone," and "Made for iPad" mean that an electronic accessory has been designed to connect specifically to iPod, iPhone, or iPad, respectively, and has been certified by the developer to meet Apple performance standards. Apple is not responsible for the operation of this device or its compliance with safety and regulatory standards. Please note that the use of this accessory with iPod, iPhone, or iPad may affect wireless performance.

iConnectAUDIO2+ and iConnectivity are trademarks of iKingdom Corp. Features of this product are protected under patent pending. For more details see <http://www.iConnectivity.com/patents>.

Table of Contents

Warranty.....	3
Compatibility	3
What's in the Box	6
Quick Start	7
Windows Driver Installation	13
The iConnectAUDIO2+ hardware.....	15
Front Panel	15
Rear Panel	16
Interactive Display.....	18
Meter Modes	18
Basic Operation.....	18
Rotary Knob Push functions	19
LED Meter Levels	19
iConfig Software.....	20
Launching iConfig.....	20
Device Menu	21
Device Info.....	22
Audio Patchbay and Audio Mixer.....	23
Audio Info	30
MIDI Info.....	34
MIDI Port Routing.....	35
MIDI Management.....	36
MIDI Port Filters.....	37
MIDI Channel Remap.....	38
MIDI Controller Data Filter	38
MIDI Controller Remap.....	39
Troubleshooting	40
Audio Specifications.....	41
Contact iConnectivity	41

iConnectAUDIO²⁺_{TM}

Thank you for purchasing the iConnectAUDIO2+ Audio + MIDI Interface. Your iConnectAUDIO2+ is a member of the most flexible interface line available, with unique features that make it ideal for the stage, studio, and club.

Here are its major features:

- Supports two computer devices simultaneously. Multi-host Device ports for connecting one or two Mac/PC computers, or one computer plus an iPad.
- In addition to the 2 x 6 analog I/O, it supports up to 10 channels of bi-directional digital audio on each of the two device ports, and includes Audio passThru™ capability from one computer to another.
- 2 XLR - ¼" Combo mic/line/instrument analog inputs, with individual +48V phantom power toggle and line/instrument mode selection.
- 4 ¼" TRS balanced analog outputs
- ¼" stereo headphone output with independent mix
- 5-pin MIDI DIN in/out
- iConfig software (Mac, Windows, iPad) for easy audio mixing/routing, and MIDI routing/processing; set-ups stored in FLASH memory on the device
- Onboard audio mixer/patchbay.
- Interactive Display for touch control of all input/output levels and +48V phantom power and line/instrument mode.
- High-resolution audio - up to 24-bit/96kHz AD/DA conversion
- USB audio and MIDI Class-Compliant.
- USB bus-powered, or use the optional power supply (sold separately) to charge an iPad as well.



What's in the Box

- The iConnectAUDIO2+.
- One USB-A to USB-B cable to connect the interface to a Mac or PC computer.

Quick Start

This Quick Start guide will get audio and MIDI in and out of your interface as simply as possible.

NOTES ABOUT THE DEFAULT SETUP:

YOU WILL NOT HEAR ANYTHING UNTIL YOU BRING UP THE LEVELS as shown below. The output levels come set all the way down for protection.

THE ANALOG COMBO INPUTS ARE ROUTED TO THE COMPUTERS, NOT THE OUTPUTS. The default setup is for recording (or processing, or monitoring). You will only hear the audio coming from the computer(s), unless you change the audio routing as explained later.

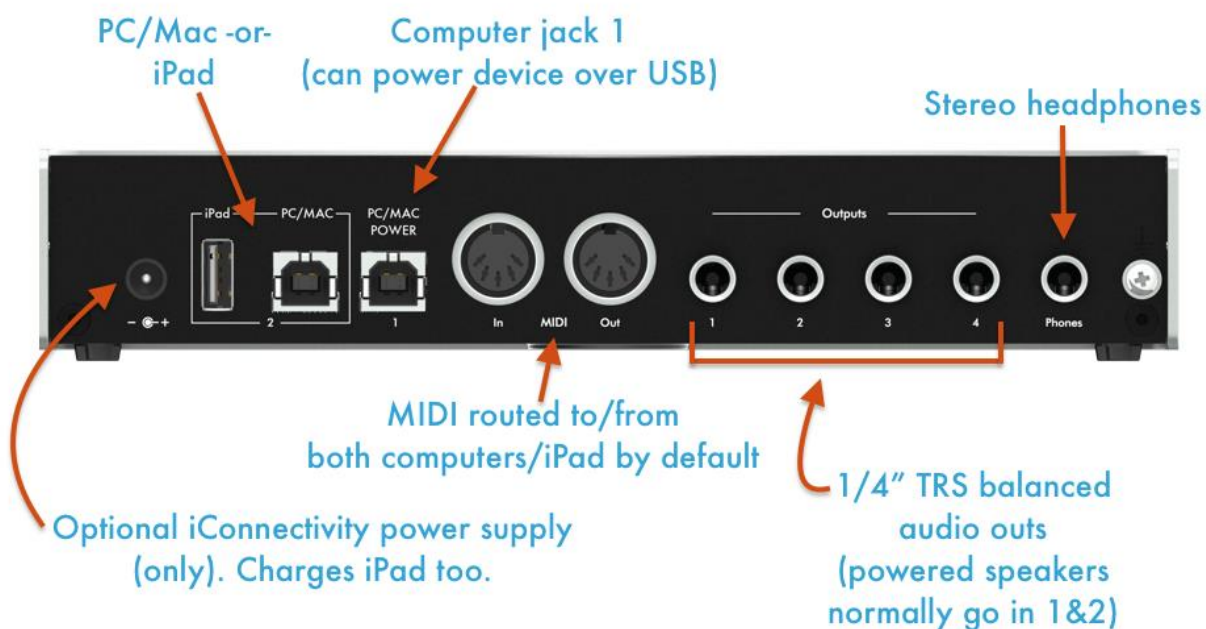

Audio hookup – connecting a Mac, PC, and/or iPad

1. Connect one or two computer devices. You can power the interface from a Mac or PC connected to Device jack 1 over the USB bus or from the optional 9V power supply connected to the DC power jack. The power supply allows operation without a Mac or PC, and it will charge an iPad connect to the interface.
2. Connect your powered monitors or power amp and speakers to Analog Out jacks 1&2, and/or plug in some headphones.

Software installation

1. If you're using a Mac or iPad, no driver is required. To run system audio (iTunes, YouTube, Skype, etc.) through your interface, select it in System Preferences -> Sound.

For Windows, please [download the driver](#) and install it. (Installation is straightforward, but for details please see [here](#).)

2. Download and install the [iConfig Software](#) to a Windows or Mac computer. This will automatically let you update your interface's firmware to the latest version, and the software accesses all the interface's functions and configuration options. Note: for successful firmware upgrade the computer must be connected to USB Device jack 1.
3. Select the iConnectAUDIO2+ as the audio output device in your DAW (or other audio software). The default 16-bit/44.1kHz audio setting ensures compatibility with iPad software that doesn't operate at higher rates, but it can be changed up to 24-bit/96kHz in the iConfig software's [Audio Info](#) tab.
4. Play some test audio, preferably in a loop. You should hear your test audio in your speakers or headphones after you raise the output level as explained in the following section.

Sound check - raising/adjusting the output level

There are two ways to adjust the output level: directly on the front panel Interactive Display, or using the iConfig software's [Audio Mixer](#).

Adjusting output levels using the Interactive Display:

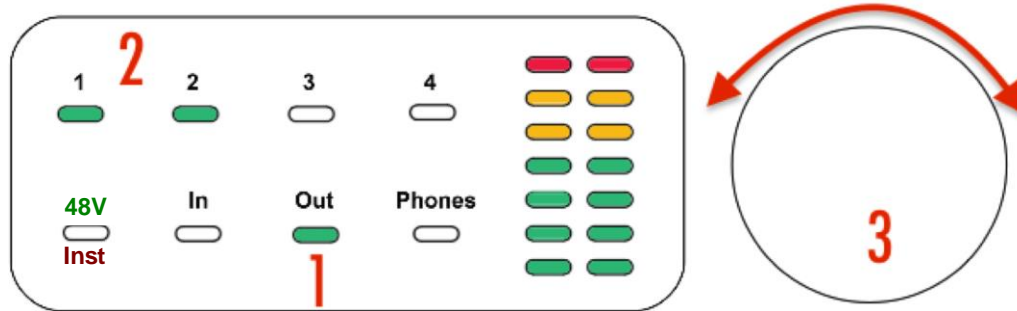

Simply touch Out (#1) (selecting the Outputs for adjustment), then 1 and 2 (#2) to select Analog Outputs 1&2, which are linked for stereo in the default setup. Then turn the Rotary control knob (#3) to raise or lower the monitor speaker level.

To adjust the headphones level, follow the same procedure, selection Phones instead of Out.

The first time you touch Out or Phones, the LED will turn green, indicating the meters are in Signal Level viewing mode . Touch a second time and the LED will turn red, indicating the meters are in Gain Set viewing mode, which shows the position of the Rotary Control rather than the audio signal level.

Adjusting output levels using the Audio Mixer:

- Launch iConfig. (If you have additional iConnectivity interfaces connected, select the iConnectAUDIO2+ in the Device Selection dialog.)

- Select the Audio Mixer tab. Mix A, the first of the available mixes in the Sub Mix/Bussing section, should already be selected.

- Bring up the two stereo faders as shown below (the SOURCE one is probably raised already). The Analog Output 1&2 fader is your monitor volume control.

You can also bring up the headphones here. In the default setup they carry the same signal as analog outs 1&2, but they have their own Sub Mix on the third Audio Mixer tab.

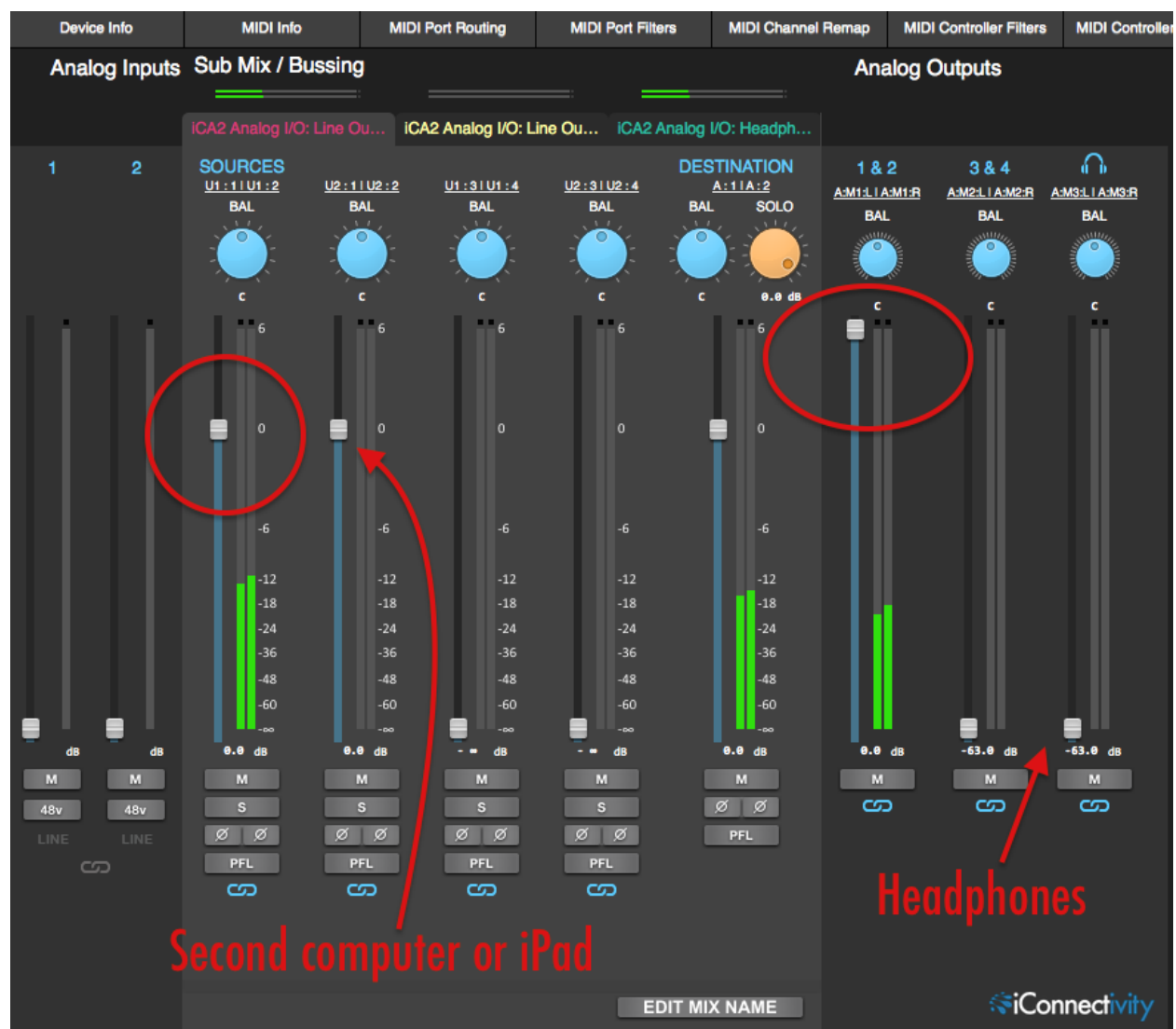

Recording to computer devices

The two Analog In combo jacks on the front panel are routed to inputs 1&2 of both computer devices in the default setup. Your music software will see them as available inputs for recording (or just monitoring or processing).

- Connect your mics, instruments, or line-level sources into the Analog combo jacks.
- Bring up the input levels and, if needed for condenser mics, turn on phantom power. You can do this in the Audio Mixer or with the Touch Panel.

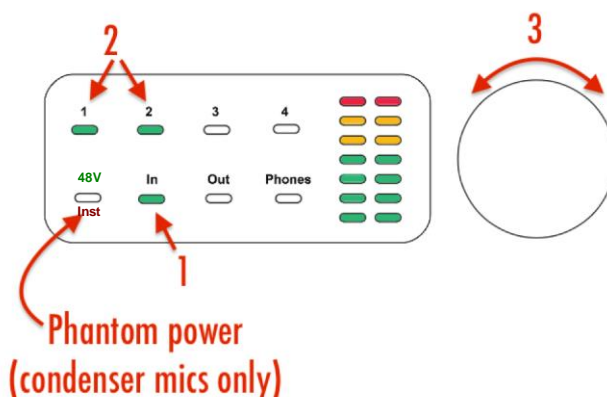
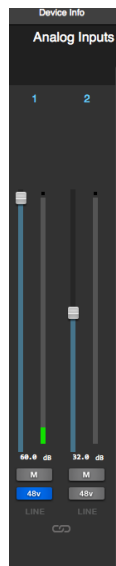

This is on the left side of the mixer.

OR: Touch In (#1) to select input levels for adjustment, touch 1 and/or 2 (#2) to select either or both inputs, then turn the Rotary Control (#3) to raise or lower the selected inputs.

Turn on phantom power if needed for condenser mics (only). This is done by touching 48V so that the indicator turns green, then touching the input numbers for which you want to apply phantom power.

MIDI

Each USB Device jack has 2 (16 channel) MIDI ports. In the default configuration, one port is for routing MIDI data to and from the 5-pin MIDI DIN jacks, and the second port is for routing MIDI data to and from the other USB Device jack.

So your music software will see two 16-channel MIDI ports available for input and output. This is Apple Logic Pro X, for example:

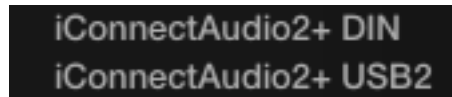

Quick Start Notes

- No additional drivers are required for Mac or iOS. Windows driver available [here](#). [Set-up instructions are in the following section](#).
- No Mac or iPad drivers are needed. The iConnectAUDIO2+ is USB class-compliant, so it's recognized automatically by Mac OS X and iOS for applications to pass audio and MIDI as soon as it's connected.
- IF YOU HEAR NOTHING FROM YOUR SPEAKERS OR HEADPHONES: please check that levels are turned up, either using the [Interactive Touch Display](#) or [Audio Mixer](#) tab in the [iConfig software](#). This is explained in the [Quick Start Guide](#).
- If you've made changes in iConfig, check that the output source you're monitoring is routed correctly in the [Audio Patchbay](#).
- The default 16-bit/44.1kHz audio setting ensures compatibility with iOS software that doesn't operate at higher rates, but it can be changed up to 24-bit/96kHz in the iConfig software's [Audio Info](#) tab.

Windows Driver Installation

Download the Windows drivers [here](#). You will see the following dialogs.

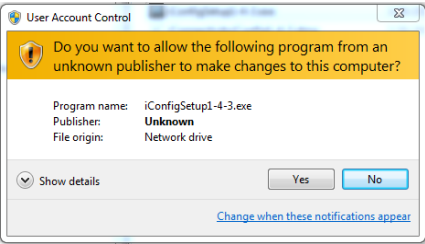
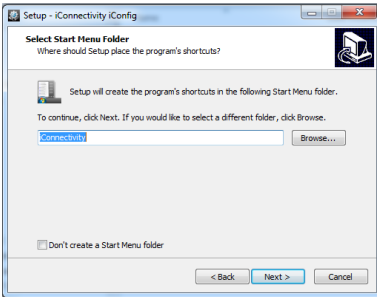
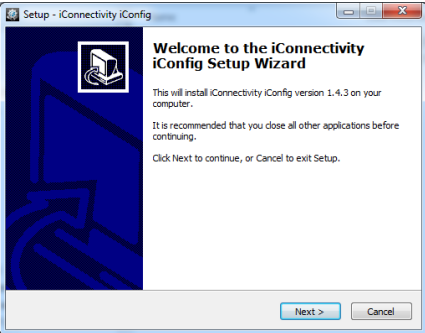
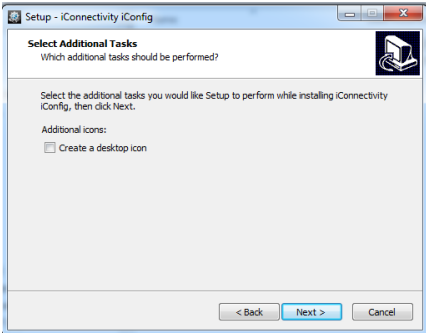
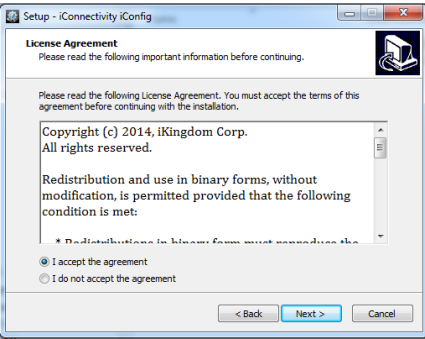
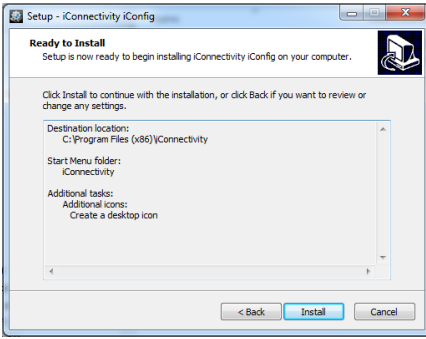
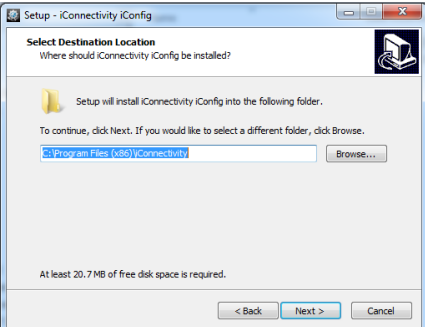
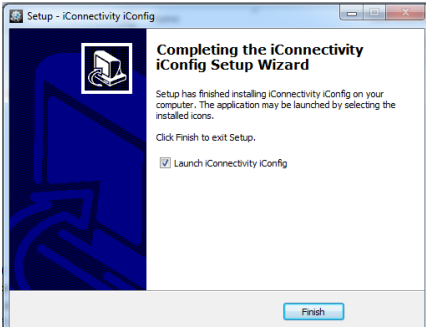
 <p>Do you want to allow the following program from an unknown publisher to make changes to this computer?</p> <p>Program name: iConfigSetup1-4-3.exe Publisher: Unknown File origin: Network drive</p> <p>Show details Yes No</p> <p>Change when these notifications appear</p>	 <p>Select Start Menu Folder</p> <p>Where should Setup place the program's shortcuts?</p> <p>Setup will create the program's shortcuts in the following Start Menu folder.</p> <p>To continue, click Next. If you would like to select a different folder, click Browse.</p> <p>Connectivity Browse...</p> <p>Don't create a Start Menu folder</p> <p>< Back Next > Cancel</p>
<p>Yes. ↓</p>	<p>Next. ↓</p>
 <p>Welcome to the iConnectivity iConfig Setup Wizard</p> <p>This will install iConnectivity iConfig version 1.4.3 on your computer.</p> <p>It is recommended that you close all other applications before continuing.</p> <p>Click Next to continue, or Cancel to exit Setup.</p> <p>Next > Cancel</p>	 <p>Select Additional Tasks</p> <p>Which additional tasks should be performed?</p> <p>Select the additional tasks you would like Setup to perform while installing iConnectivity iConfig, then click Next.</p> <p>Additional icons:</p> <p><input type="checkbox"/> Create a desktop icon</p> <p>< Back Next > Cancel</p>
<p>Next. ↓</p>	<p>Desktop icon is optional. ↓</p>
 <p>License Agreement</p> <p>Please read the following important information before continuing.</p> <p>Please read the following License Agreement. You must accept the terms of this agreement before continuing with the installation.</p> <p>Copyright (c) 2014, iKingdom Corp. All rights reserved.</p> <p>Redistribution and use in binary forms, without modification, is permitted provided that the following condition is met:</p> <p>* Redistributions in binary form must reproduce the</p> <p><input checked="" type="radio"/> I accept the agreement <input type="radio"/> I do not accept the agreement</p> <p>< Back Next > Cancel</p>	 <p>Ready to Install</p> <p>Setup is now ready to begin installing iConnectivity iConfig on your computer.</p> <p>Click Install to continue with the installation, or click Back if you want to review or change any settings.</p> <p>Destination location: C:\Program Files (x86)\Connectivity</p> <p>Start Menu folder: iConnectivity</p> <p>Additional tasks: Additional icons: Create a desktop icon</p> <p>< Back Install Cancel</p>
<p>Accept the agreement. ↓</p>	<p>Visual Studio Redistributable installed if needed. ↓</p>
 <p>Select Destination Location</p> <p>Where should iConnectivity iConfig be installed?</p> <p>Setup will install iConnectivity iConfig into the following folder.</p> <p>To continue, click Next. If you would like to select a different folder, click Browse.</p> <p>C:\Program Files (x86)\Connectivity Browse...</p> <p>At least 20.7 MB of free disk space is required.</p> <p>< Back Next > Cancel</p>	 <p>Completing the iConnectivity iConfig Setup Wizard</p> <p>Setup has finished installing iConnectivity iConfig on your computer. The application may be launched by selecting the installed icons.</p> <p>Click Finish to exit Setup.</p> <p><input checked="" type="checkbox"/> Launch iConnectivity iConfig</p> <p>Finish</p>
<p>Next. ↗</p>	<p>Finish.</p>

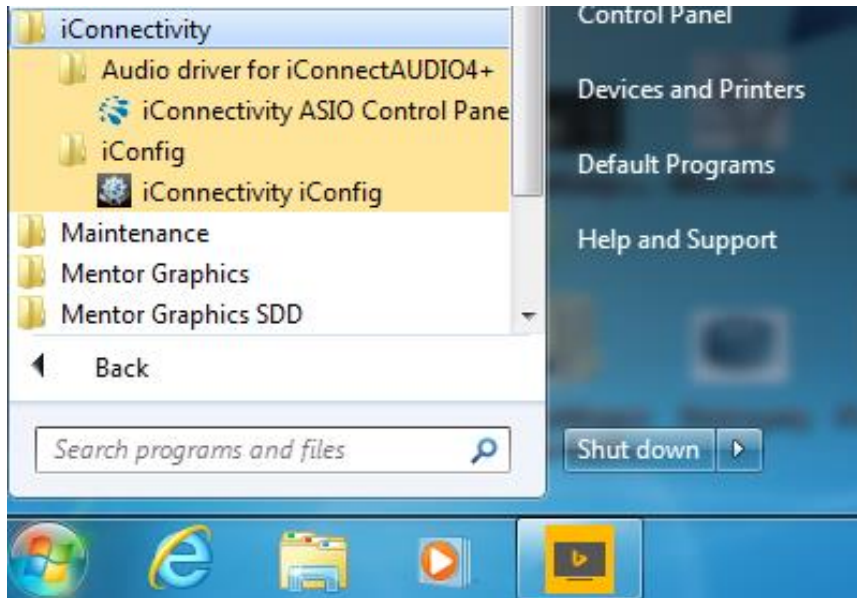

The Start Menu after installing the Windows driver and the iConnectivity iConfig software.

The iConnectAUDIO2+ hardware

Front Panel



1 & 2 Analog In Jacks 1 & 2

XLR - 1/4" Combo balanced mic/line/instrument inputs.

Connect microphones with XLR plugs. The gain range is 60dB in 1dB increments.

The 1/4" inputs offer balanced/switchable low and high impedance.

Connect Hi-Z instrument inputs (electric guitars, basses, etc.) with 1/4" plugs; they go through a -20dB pad, with a gain range of -20dB to +40dB in 1dB increments.

Connect line-level inputs (synthesizers, DJ rigs, etc.); they go through a -20dB pad, with a gain range of -20dB to +40dB in 1dB increments.

Select +48V phantom power if needed for condenser mics.

3 Interactive Display, 4 Rotary Control Knob

(For details see [Interactive Display section.](#)) Easy capacitive touch interface lets you adjust, view, and store analog audio levels, select the input impedance, and turn +48V phantom power on/off for condenser mics.

Rear Panel



5 Power jack for the optional iConnectivity Power Transformer (sold separately)

Please use only the iConnectivity 9V center positive transformer, or you risk damaging the device.

The iConnectivity Power Transformer operates over a range of 100-240V/50 or 60Hz, so it can be used internationally with wall plug adapters.

6 Computer Device jack 2

Connect the interface to a Mac or PC with the included iConnectivity USB-B to USB-A cable. Or connect an iPad using the Apple Lightning cable that came with your iPad.

The iPad will charge if you use the optional iConnectivity 9V Power Transformer.

7 Computer Device jack 1

Connect the interface to a Mac or PC with the included iConnectivity USB-B to USB-A cable.

Only this jack will power the device over the USB bus, so please use it if you're only connecting one Mac or PC.

8 MIDI DIN In & Out

These jacks accept 5-pin MIDI DIN plugs for standard MIDI hardware. MIDI is transmitted at the standard MIDI rate (31.25 Kbps).

9 Analog Out Jacks 1 – 4

¼" balanced TRS outputs. The output is 13dBu/11dBV, a very high level, so please use caution to avoid overloading subsequent equipment in the signal path.

Normally Analog Outs 1 & 2 would be connected to powered monitors or a stereo amp + speakers.

10 – Headphone Jack

For stereo headphones with a ¼" TRS plug.

11 – Chassis grounding screw

In case of grounding issues when connecting multiple electronic devices.



12 – Security Lock Port

Interactive Display

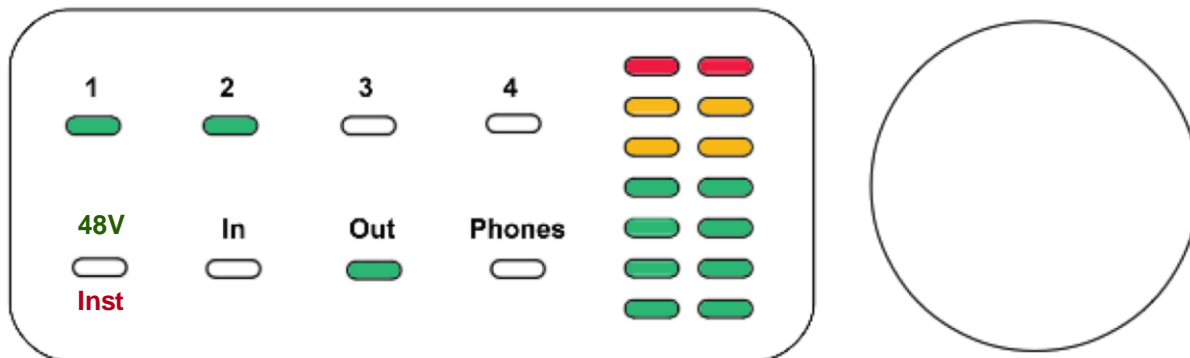

The iConnectAUDIO2+'s Interactive Display makes it simple to view and adjust analog input and output levels, enable/disable 48V phantom power for condenser mics, and perform various utility functions without using the iConfig software.

It consists of a capacitive touch panel with eight touch zones and dual 8-stage LED meters, and a Rotary Control Knob that also performs various functions when it's pushed/double-pushed.

Meter Modes

There are two meter viewing modes. Successive touches of In, Out, or Phones toggles between the two modes:

Signal Level mode, indicated by a green bottom row LED. The LED meters display VU (the signal level).

Gain Set mode, indicated by a red bottom row LED. This is like showing the position of a volume control in the meters (the Rotary Knob is continuous, so you can't tell the position by looking at the knob).

The 48V/Inst touch zone has no effect on the viewing mode, since it's an on/off function.

Basic Operation

1. Touch the region centered around one of the four indicators on the bottom row to select a function: 48V/Inst, In, Out, or Phones. Note that the 48V/Inst indicator has two states: red and green. Green indicates the mode for changing 48V phantom power settings, while red indicates the mode for for changing between line and instrument impedance settings. Subsequent touches of the 48V/Inst indicator toggles between these two modes.
2. Touch numbers 1 through 4 on the top row to select an analog input or output for adjustment (or to change 48V phantom power or line/inst mode for the inputs).
3. Turn the Rotary Knob to adjust the In, Out, or Phones level.

Example: adjust the level of Analog Outs 1&2, which are connected to your powered monitors.

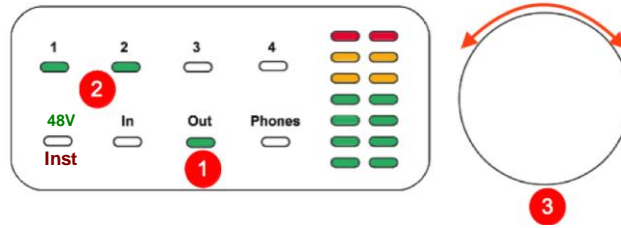

1. Touch “Out” on the bottom row.

- The LED turns green (Signal Level mode); you may want to touch it again to toggle it to Gain Set mode.

2. Touch “1” and “2” on the top row (or either one if they’re configured as a stereo pair).

3. Turn the Rotary Knob to adjust the level.

Rotary Knob Push functions

FUNCTION	ROTARY KNOB PUSH COMMAND
Mute all outputs	Double push
Save all settings to internal memory	Single push
Power down	Push and hold until each meter shows a single red and a single amber LED
Power up	Single push (when powered down)
Bootloader mode (for manual firmware updates)	Push and hold until each meter shows a single red LED, then release
Reset	Push and hold until all LEDs turn off, then release

LED Meter Levels

Gain/Attenuation

Ins	Outs/phones
60 dB	0 dB
50, 60	-10, 0
40, 50	-20, -10
30, 40	-30, -20
20, 30	-40, -30
10, 20	-50, -40
1, 10	-63, -50

Ch 1/3 Ch 2/4
phones L phones R

iConfig Software

iConfig, the included software program for Mac and Windows provides access to the set-up and routing features in your iConnectAUDIO2+, as well as any other iConnectivity interfaces connected to your system.

The active settings "snapshot" is stored in the interface's onboard flash memory. It can be copied into the iConfig software for editing (the "Restore from FLASH" command).

iConfig works the same on Mac, iPads, and Windows.

Launching iConfig



When you have multiple iConnectivity interfaces connected to your computer, the Device Selection dialog will appear; simply select the one to be configured. If you have only the iConnectAUDIO2+, it will be selected automatically in the dialog without intervention.

iConfig checks for firmware updates every time it's launched.

Device Menu

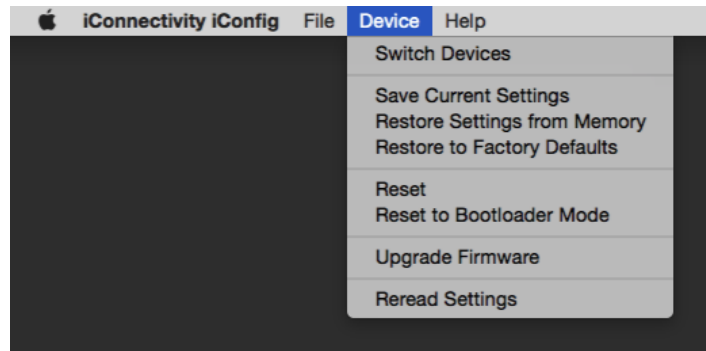

Switch Devices – Brings up the Device Selection dialog, allowing you to choose a different iConnectivity interface to be configured.

All the following have a confirmation dialog, so you have a chance to cancel before the operation:

Save Current Settings – Write the current iConfig settings to the iConnectAUDIO2+'s flash memory.

Restore Settings from Memory – Transfers the current snapshot from the iConnectAUDIO2+'s flash memory into iConfig.

Restore to Factory Defaults – Removes all user changes to the iConnectAUDIO2+'s configuration.

Reset – All digital devices can get “confused” and require resetting.

Reset to Bootloader Mode – When the device restarts it will be in Bootloader Mode, ready to receive firmware changes. This lets you load specific firmware files.

Upgrade Firmware – Checks whether your firmware is current. If not, it installs it from www.iConnectivity.com. iConfig checks for updates each time it's launched, and can install them automatically if you give permission.

Reread Settings – Redraws the application screen.

Device Info

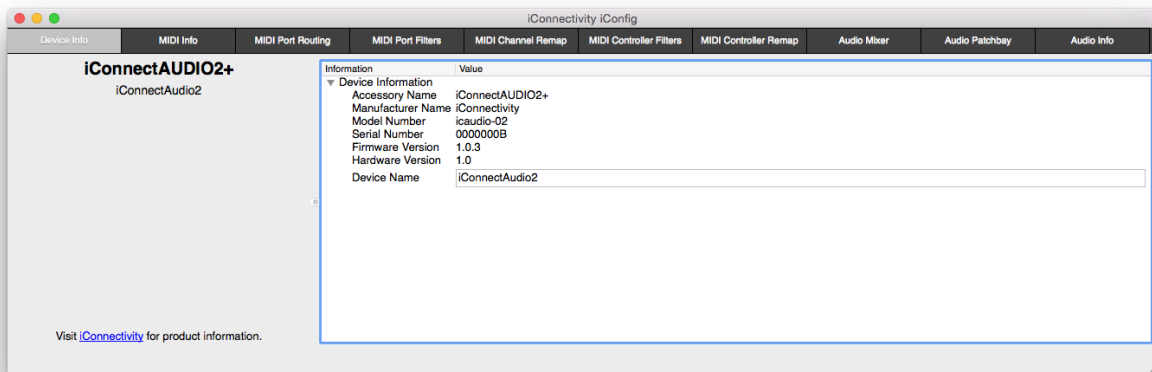

This displays information about the connected audio interface, including the firmware version. Note that the Device Name field can be edited, so you can give your interface a custom name.

Audio Patchbay and Audio Mixer

The Audio Patchbay and Audio Mixer are powerful tools for configuring the iConnectAUDIO2+ interface. They allow you to:

- Define the routing of any analog or digital inputs to any analog or digital outputs.
- Route any input to multiple outputs.
- Combine multiple inputs and route them to a single output using internal mixers.

The easiest way to understand the Audio Patchbay and Audio Mixer is just to follow this short tutorial.

iConfig's Audio Patchbay is a routing matrix. It has sources horizontally across the top and destinations vertically on the right. Touch the grid to add or remove a routing.

NOTE: THE PATCHBAY WILL LOOK DIFFERENT IF IT'S BEEN CHANGED FROM THE FACTORY DEFAULT SETUP SHOWN HERE!

We'll start with the default setup, annotated to help make it clear what's going on. Assume two computers are connected. Computer #1 is connected to USB port 1 on the rear panel, and Computer (or iPad) #2 is connected to USB port 2.

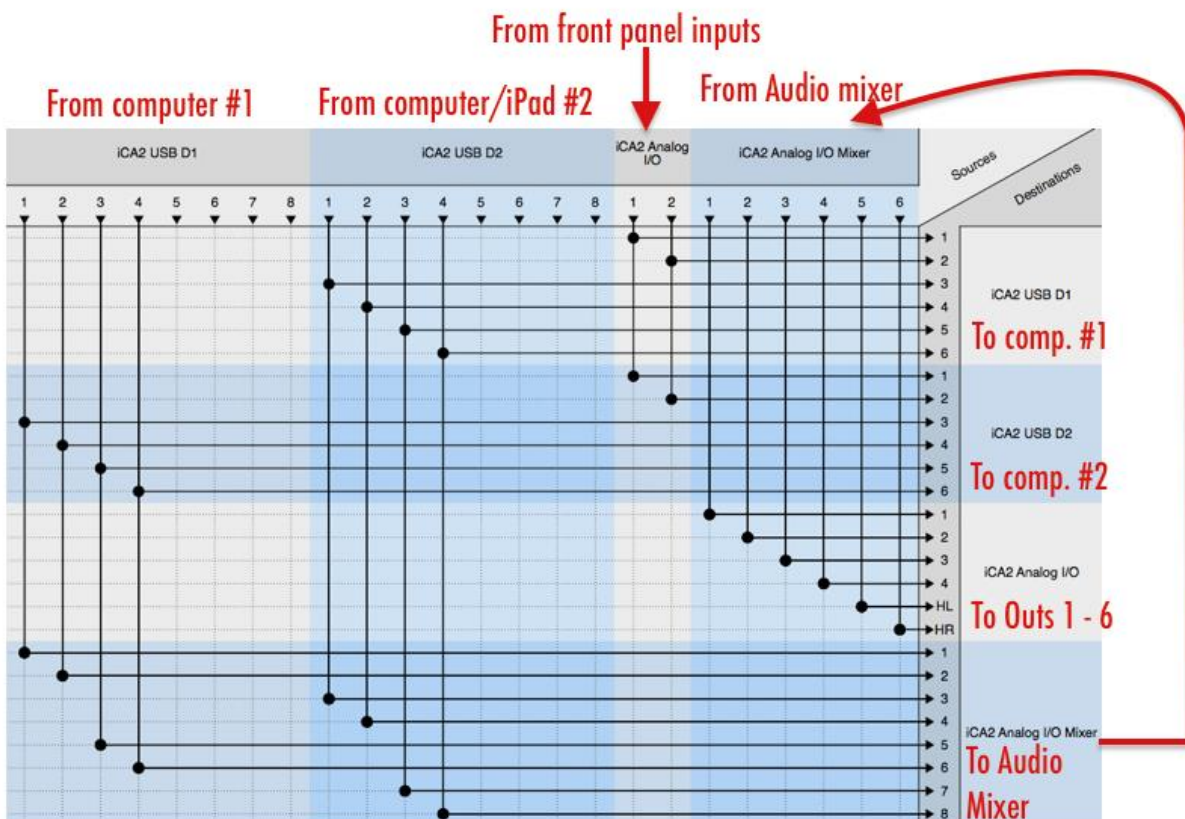

iCA2 USB D1: iConnectAUDIO2+ USB device jack 1. There are eight bi-directional audio ports available on this USB connection.

iCA2 USB D2: USB device jack 2, with another eight bi-directional audio ports.

iCA2 Analog I/O: The two analog inputs on the front panel (shown on the “Sources” axis, and the six analog outputs on the back panel (shown on the “Destinations” axis).

iCA2 Analog I/O Mixer: The internal mixer section in the iConnectAUDIO2+. Eight mixer inputs are available on the “Destinations” axis, and three pairs of independent submixes are available on the “Sources” axis. These three pairs of submixes appear as three separate mixer tabs on the Audio Mixer control panel, explained later.

Input routings:

Referring to the view of the Audio Patchbay above, here is an explanation of how the iConnectAUDIO2+ inputs have been routed in the default configuration:

- The front panel Combo inputs are routed to ports 1&2 of both computers. That's so they're available in your music software for recording (or processing, or just monitoring).
- Ports 1 through 4 from **Computer #1** are routed to two destinations: to Computer/iPad #2 ports 3,4,5,&6; and to inputs 1&2 and 5&6 of the iConnectAUDIO2+ internal Audio Mixer.
- Ports 1 through 4 from **Computer #2** are also routed to two destinations: Computer #2 ports 3,4,5,&6; and to inputs 3&4 and 7&8 of the Audio Mixer.

Audio Mixers:

The internal mixers allow signals to be combined within the interface for uses such as low-latency monitoring. The analog mixer inputs can be mixed independently on three separate stereo mix buses. The diagram below illustrates how the internal mixers are used.

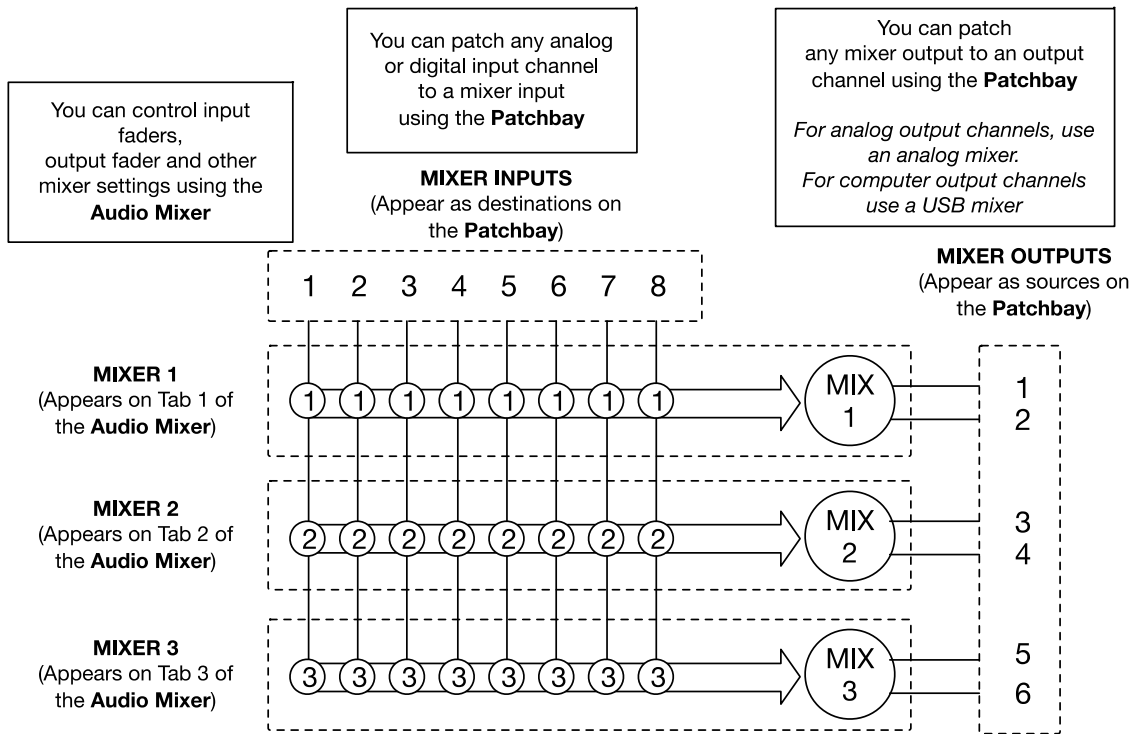

Using iConnectAUDIO's Internal Mixers

Audio Mixer Routing:

The Patchbay shows which input channels are routed to the eight inputs of the mixer section, and which output channels are connected to the three pairs of mixes from the mixer section. The drawing below shows the relationship between the Patchbay mixer inputs and the Audio Mixer control section, used to set the mixing levels.



In the screen shot above, we're looking at the mix going to **Analog Outs 1&2** on the **red tab**.

But sometimes you want each output pair to have an independent mix, maybe for stage and house, or cueing, or studio and control room - there are all kinds of reasons.

The same four pairs from the patchbay are available in the same positions on the **yellow tab**, which is going to **Analog Outs 3&4**, and the **green tab** has the same ones for the **headphones**.

Note that the mixer sources and outputs shown on the Patchbay can also be viewed in the audio Mixer, as shown on the next page.

The cutout Source and Destination choice boxes shown on the page are accessed one at a time by clicking on the white source name (e.g. U1:1|U1:2). Changes made here are reflected in the Audio Patchbay and vice versa.

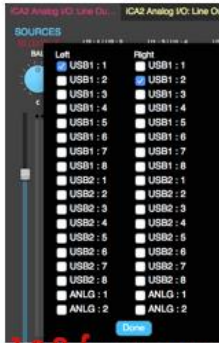

Analog outs
5&6/phones mix
(green tab)



outs 1&2 from comp. #1

to Analog outs 3&4
mix (yellow tab)

To Analog outs 1&2

Input channel
faders

Output channel
faders

Other info about the mixer:

- Double-click most faders and the BAL (Balance) knobs to set them to 0.
- The rest of the controls are as follows:

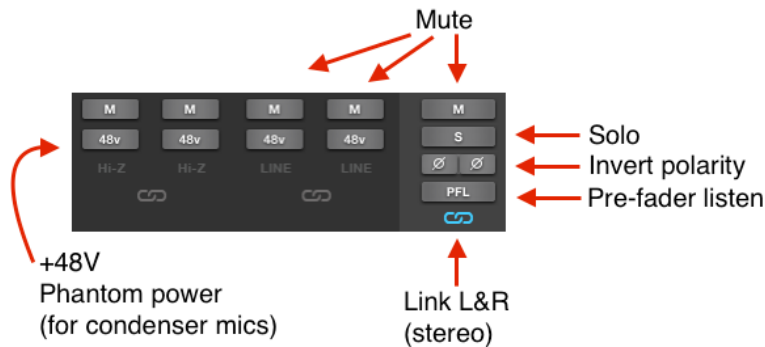

The USB Mixers

There are two USB mixers, one for each computer device. These are for mixing analog and/or computer input channels to send to a computer output channel. Each USB mixer can accept inputs from either computer/iPad or any analog input, but it can only be routed to one computing device.

To enable one or both USB mixers, go to the Audio Information tab. In this example we've set up four channels on computer #1 (AKA "iCA2 USB D1 domain" in the software). We're not using the other USB mixer, since it's not needed.

Click source	Monitor level
▼ Mixer Information	
Mixer configuration	2 - 8 Input Buses per Mixer, 6 Mix Buses
Input channels for mixer on iCA2 USB D1 domain	4
Mixes to outputs on iCA2 USB D1 domain	4
Input channels for mixer on iCA2 USB D2 domain	0
Mixes to outputs on iCA2 USB D2 domain	0
Input channels for mixer on iCA2 Analog I/O domain	8
Mixes to outputs on iCA2 Analog I/O domain	2

After clicking Commit and Reset, the iConnectAUDIO2+ restarts. The Patchbay is cleared and you will need to define the routing for your new configuration.

In the routing example below, we're sending Computer #1's outputs 3 through 6 into the USB mixer, then back into inputs 5&6 for recording.

(Remember: the USB D1 Mixer's outputs can only go to Computer #1; if we'd enabled the D2 Mixer, it could only go to Computer/iPad #2.)

To complete a realistic setup example, we've also routed Computer #1 and Computer #2 outs into the analog mixer. The two analog submixes are routed to analog outs 1&2 and 5&6 (the headphones).

Finally, we've routed the audio inputs are routed to computer #1's inputs 1&2.

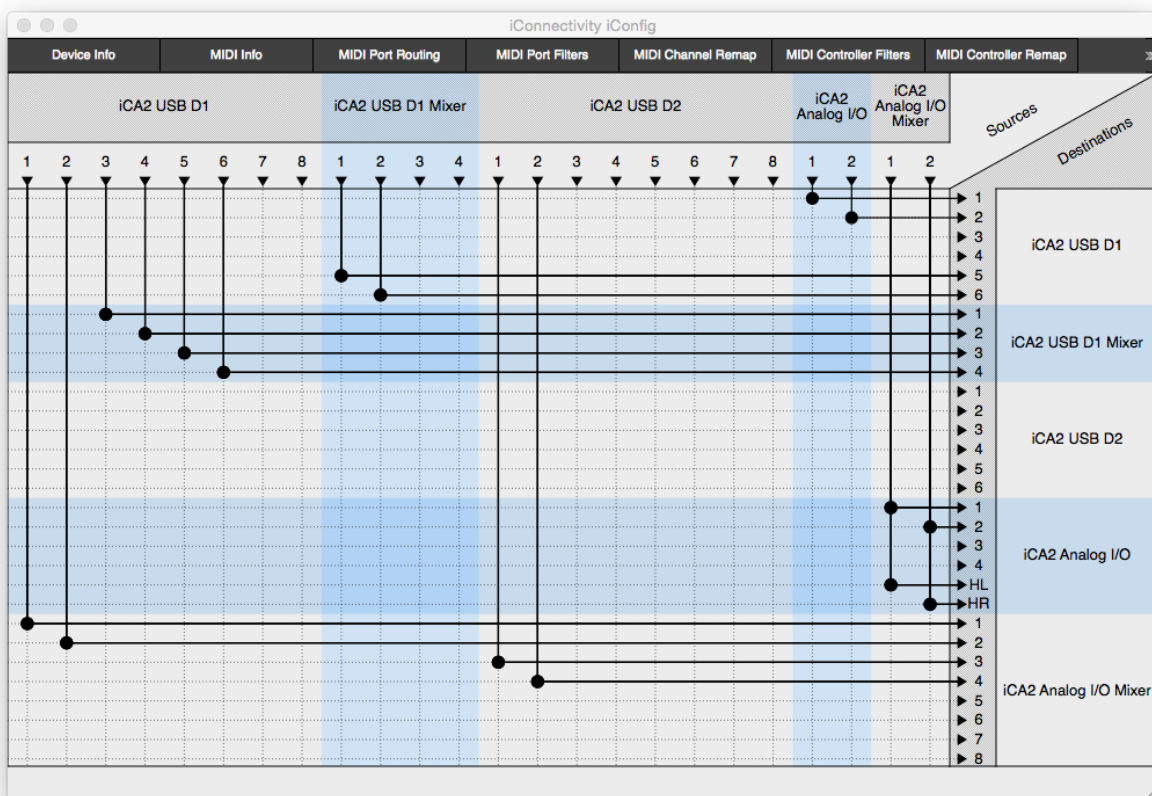

Please check the iConnectivity website for videos and blog posts for more information.

Audio Info

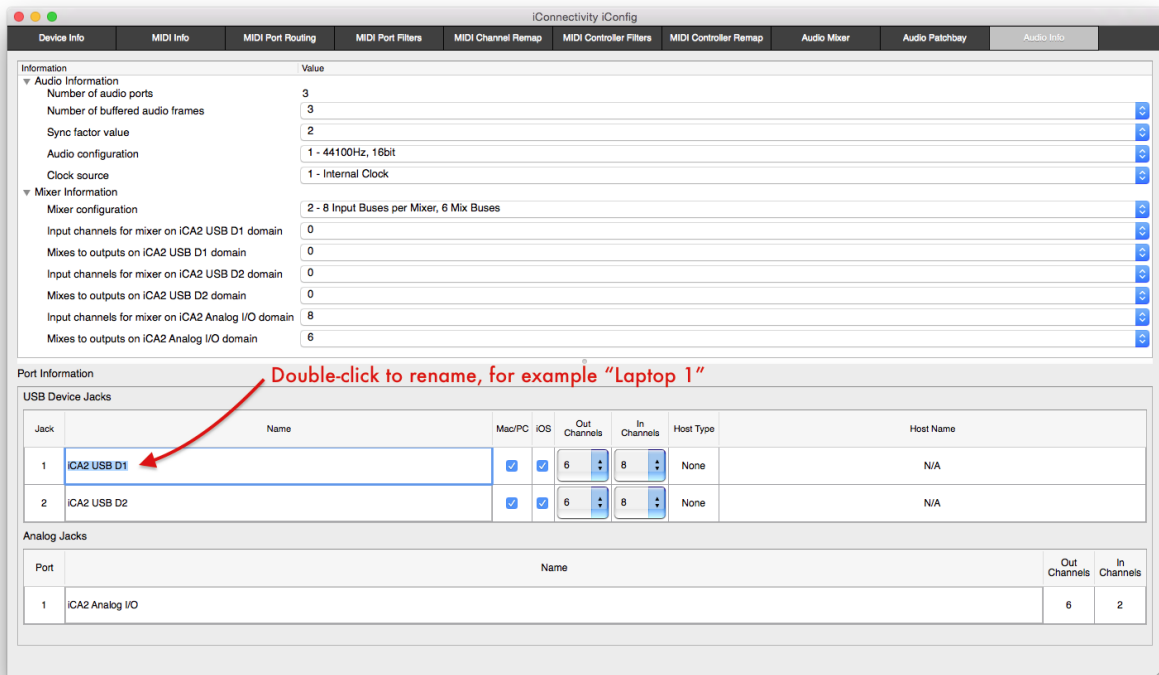

This is the iConnectAUDIO2+'s information and settings screen. As soon as you make a change, you will have the opportunity to commit your edits to the interface or to cancel:

For changes to take effect perform a "Commit & Reset".

Commit & Reset

Abandon Changes

Audio Information

Number of audio ports (fixed) – 3: two USB Device ports for computer devices, one 2x6 analog port.

Number of buffered audio frames and *Sync factor value*: as with every device that processes digital audio, audio goes into a buffer before it is processed, and it takes a small fraction of a second for audio to fill the buffer as it streams through. This latency is compensated for with the Sync factor value parameter so that incoming and outgoing audio is in sync.

The larger the audio frame buffer, the longer this takes, but the lower the strain is on the device; conversely, smaller buffers lower the processing latency and require more computing horsepower.

The default settings offer low latency and solid audio performance. However, you may wish to experiment with faster settings; or if you hear glitches, increase the buffer.

Audio Configuration – the sample rate and bit depth setting. This defaults to the CD-standard 16-bit/44100Hz setting to ensure compatibility with all iPad software. Higher bit and (to a lesser degree) sample rates offer higher sound quality in some applications, but they use more processing resources.

- ✓ 1 - 44100Hz, 16bit
- 2 - 48000Hz, 16bit
- 3 - 88200Hz, 16bit
- 4 - 96000Hz, 16bit
- 5 - 44100Hz, 24bit
- 6 - 48000Hz, 24bit
- 7 - 88200Hz, 24bit
- 8 - 96000Hz, 24bit

The following **Audio Configuration Table** shows the processing footprints for every possible configuration.

Audio Configuration	1	2	3	4	5	6	7	8
Frequency (KHz)	44.1	48	88.2	96	44.1	48	88.2	96
Bit Depth (USB)	16	16	16	16	24	24	24	24
Max USB Audio Channels	20	20	12	12	20	20	12	12
Opt 1 Mixer Max Src	8	8	6	6	8	8	6	6
Opt 1 Mixer Max Dst	6	6	4	4	6	6	4	4
Opt 2 Mixer Max Src	6	6	4	4	6	6	4	4
Opt 2 Mixer Max Dst	8	8	6	6	8	8	6	6
Clock Sources	1 - Internal Clocking							
	2 - USB jack 1							
	3 - USB jack 2							

Mixer Information

Mixer Configuration — There are two options: 8 input Buses per Mixer, 6 mix Buses (the default); and vice versa, as shown below. This comes down to a choice between more sources and more destinations.

Device Info	MIDI Info	MIDI Port Routing	MIDI Port Filters	MIDI Channel Remap
Information		Value		
▼ Audio Information				
Number of audio ports	3			
Number of buffered audio frames	3			
Sync factor value	2			
Audio configuration	1 - 44100Hz, 16bit			
Clock source	1 - Internal Clock			
▼ Mixer Information				
Mixer configuration	1 - 6 Input Buses per Mixer, 8 Mix Buses ✓ 2 - 8 Input Buses per Mixer, 6 Mix Buses			
Input channels for mixer on iCA2 USB D1 domain	0			
Mixes to outputs on iCA2 USB D1 domain	0			
Input channels for mixer on iCA2 USB D2 domain	0			
Mixes to outputs on iCA2 USB D2 domain	0			
Input channels for mixer on iCA2 Analog I/O domain	8			
Mixes to outputs on iCA2 Analog I/O domain	6			
Port Information				

Enabling USB mixer Destination Busses – The USB Mixers are not enabled in the iConnectAUDIO2+'s factory default set-up. Since most DAWs and other software programs have mixing built in (and the factory default is intended for use with DAWs), they aren't needed.

When you do need the USB1 or USB2 Mixers, for example in a live situation, the way to enable them is to change the number of "Mixes to outputs on USB1 [and/or USB2] domain" from 0 to an available number. as shown below:

Device Info	MIDI Info	MIDI Port Routing	MIDI Port Filters	MIDI Channel Remap
Information		Value		
▼ Audio Information				
Number of audio ports	3			
Number of buffered audio frames	3			
Sync factor value	2			
Audio configuration	1 - 44100Hz, 16bit			
Clock source	1 - Internal Clock			
▼ Mixer Information				
Mixer configuration	2 - 8 Input Buses per Mixer, 6 Mix Buses			
Input channels for mixer on iCA2 USB D1 domain	0			
Mixes to outputs on iCA2 USB D1 domain	✓ 0			
Input channels for mixer on iCA2 USB D2 domain	2			
Mixes to outputs on iCA2 USB D2 domain	4			
Input channels for mixer on iCA2 Analog I/O domain	8			
Mixes to outputs on iCA2 Analog I/O domain	6			
Port Information				

Port Information - On the two USB Device Jacks, enable/disable Mac/PC and/or iOS support; and set the number of input and output channels available.

The number of Analog Jacks is fixed, of course: 6 outputs (4 Analog Out Jacks + 2 for Headphone Jacks 1&2); and Analog In Jacks 1 & 2.

Note that the names of the devices can be edited.

MIDI Info

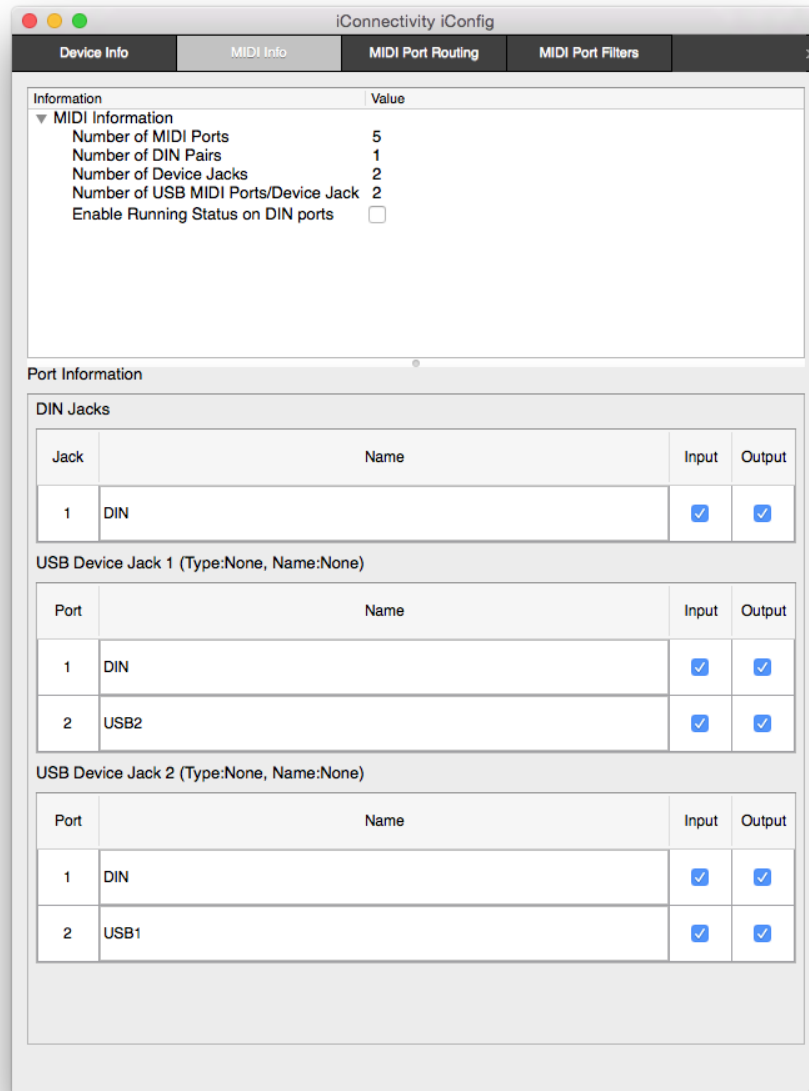

MIDI Information: Summary MIDI information about the iConnectAUDIO2+'s physical ports, as well as the 16-channel MIDI Ports available on each connected computer for routing.

Running Status on DIN ports (defaults to off) – Running status is a way of reducing the amount of MIDI data that must be sent. It works by assuming that the first part of the MIDI message - the status byte that identifies what it is (for example a note) – remains the same until further notice. Running status must be implemented correctly by the receiving device to work; we recommend enabling it only if you can confirm that this is the case.

Port Information: Enable/disable MIDI in and out for the 5-pin DIN jacks and each of the two USB computer devices individually. All default to on, and each can be renamed (e.g. DIN could be changed to the name of the MIDI instrument you have connected).

Port Names: The MIDI ports have been named to reflect the default port routing. For example, the second port on USB Device Jack 1 is named “USB2” because it is routed to USB Device Jack 2 (see MIDI Port Routing section). The ports can be custom named to your liking on the MIDI info tab. The names assigned to the MIDI ports will also appear in music applications running on a connected computing device. If you change the names of the MIDI ports you will need to remove and re-install the iConnectAUDIO2+ on the computing device in order to have the new names reflected there.

MIDI Port Routing

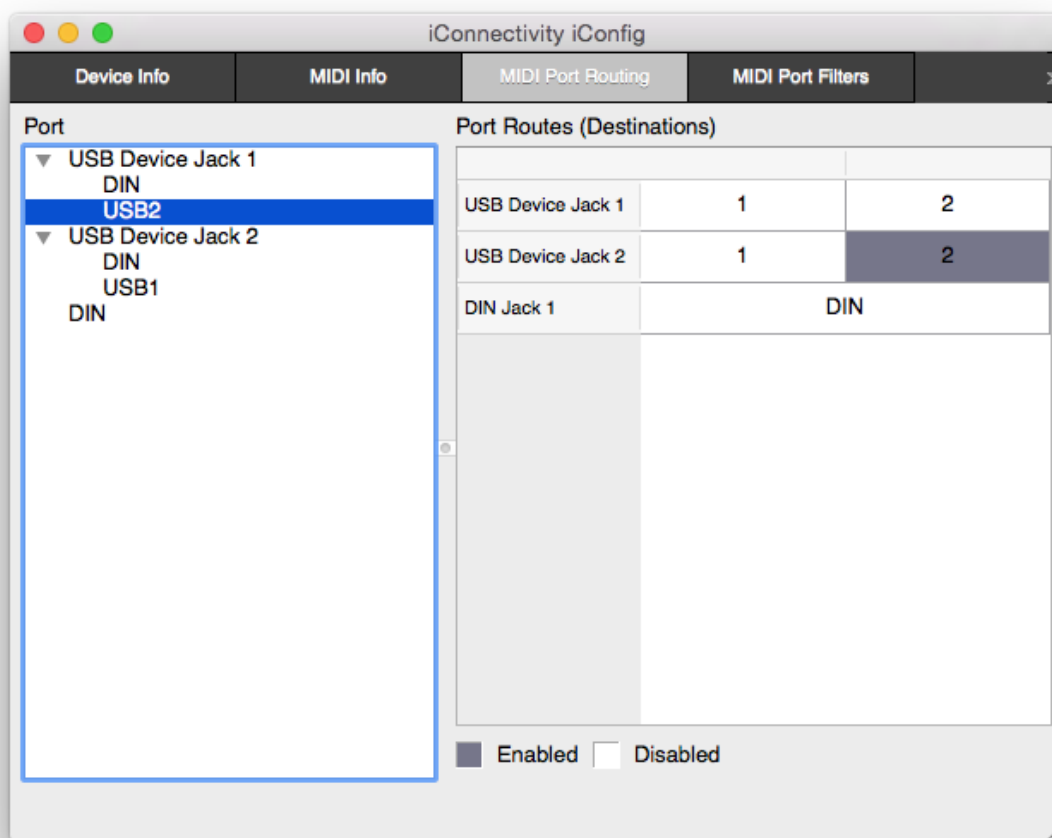

This matrix is for routing the 16-channel bi-directional MIDI Ports, with sources on the left and destinations on the right. You can re-route or duplicate MIDI ports going in and out.

To view the routing for any input (source) port, select that port in the left hand pane labelled “Port.” The right hand pane labelled “Port Routes” will indicate destination ports

with dark shading. You can select or deselect destination ports by clicking on the port in the right hand pane.

In the screen shot above, the blue shading indicates that the second port on USB Device Jack 1 has been selected and is routed to MIDI port 2 on USB Device Jack 2.

In the default configuration, the rear-panel MIDI DIN In is routed to both computer devices; and each computer device has one MIDI Port going to the other computer device, and another to the MIDI DIN out.

MIDI Management

In addition to the MIDI routing capability, four types of processing for both MIDI input and output streams are available to manage the MIDI data in your setup. These are described in the following sections. Note that the processing and routing is applied in the following order:

1. Input port filtering
2. Input controller filtering
3. Input channel remapping
4. Input controller remapping
5. Routing (distribution and merging of input data to output paths)
6. Output port filtering
7. Output controller filtering
8. Output channel remapping
9. Output controller remapping

MIDI Port Filters

The screenshot shows the MIDI Port Filters interface. The 'Filter Type' dropdown is set to 'Input'. The 'Filtered Ports' list shows 'USB Device Jack 1' selected, with 'DIN' and 'USB2' as sub-items. The 'Filtered Ports' table has columns for Channel (1-16) and rows for various MIDI event types. 'Active Sensing Events' is highlighted in grey, indicating it is enabled. A legend at the bottom shows a grey square for 'Enabled' and a white square for 'Disabled'.

Channel	1	2	3	4	5	6	7	8	9	10	11	12	13	14	15	16
Pitch Bend Events																
Channel Pressure Events																
Program Change Events																
Control Change (CC) Events																
Poly Key Pressure Events																
Note On/Off Events																
Reset Events																
Active Sensing Events																
Realtime Events																
Tune Request Events																
Song Select Events																
Song Position Pointer Events																
Time Code (MTC) Events																
System Exclusive Events																

This is where you can filter out various types of MIDI messages on each individual incoming and outgoing MIDI port, and (when applicable for the data type) on individual MIDI channels.

Select the Port to apply MIDI data filtering to from the column on the left. In this screen shot, the MIDI DIN port to and from the computer connected to USB Device Jack 1 is selected.

In the factory default setup, shown here, only Active Sensing Events are being filtered (it's grey, indicating that filtering is enabled). The MIDI data types at the top of the list, starting with Pitch Bend, are performance controls that can be applied to individual channels. Reset Events and the data types below it don't carry channel information.

Remap Type (top left) selects whether you're filtering the input going to or the output coming from each Port.

MIDI Channel Remap

The screenshot shows the MIDI Channel Remap interface. On the left, the 'Remap Type' is set to 'Input' and the 'Port' is 'USB Device Jack 1' with 'DIN' selected. The main area is a 'Remap Channels' table with 16 columns (Channels 1-16) and several rows of data types. All data types are currently mapped to Channel 1.

Channel	1	2	3	4	5	6	7	8	9	10	11	12	13	14	15	16
Remap to Channel	1	1	1	1	1	1	1	1	1	1	1	1	1	1	1	1
Pitch Bend																
Channel Pressure																
Program Change																
Control Change																
Poly Key Pressure																
Note On/Off																

Legend: Enabled Disabled

This matrix is for remapping – changing - entire MIDI channels to different ones, or just various data types (Pitch Bend, Channel Pressure, etc.).

Remap Type (top left) selects whether to modify the input going to or the output coming from each Port.

Everything is assigned to MIDI Channel 1 in the default setup.

MIDI Controller Data Filter

The screenshot shows the MIDI Controller Data Filter interface. On the left, the 'Filter Type' is set to 'Input' and the 'Port' is 'USB Device Jack 1' with 'USB2' selected. The main area is a 'Continuous Controller Filters' table with 16 columns (Channels 1-16) and 8 rows (Controller Filter 1-8). Each filter is currently set to '0 - Bank Select (coarse)'.

Channel	1	2	3	4	5	6	7	8	9	10	11	12	13	14	15	16	Controller ID
Controller Filter 1																	
Controller Filter 2																	0 - Bank Select (coarse)
Controller Filter 3																	0 - Bank Select (coarse)
Controller Filter 4																	0 - Bank Select (coarse)
Controller Filter 5																	0 - Bank Select (coarse)
Controller Filter 6																	0 - Bank Select (coarse)
Controller Filter 7																	0 - Bank Select (coarse)
Controller Filter 8																	0 - Bank Select (coarse)

Legend: Enabled Disabled

For each MIDI port, this matrix is for filtering (removing from the datastream) any MIDI controller on any of the 16 MIDI channels.

Filter Type (top left) selects whether to modify the input going to or the output coming from each port.

Click where it says 0 - Bank Select (coarse) for a pop-up choice of all 128 MIDI Controllers.

MIDI Controller Remap

For each MIDI port, this matrix is for remapping (converting) any MIDI controller on any of the 16 MIDI channels to a different one. The entire list of 127 MIDI controllers is available as a Source and a Destination under the drop-down menu s.

Remap Type (top left) selects whether to modify the input going to or the output coming from each port.

Here the Mod wheel from a MIDI instrument in the DIN Port is being converted to Breath Control.

Troubleshooting

No sound from speakers or headphones connected to the interface

Please check that levels are turned up in the Audio Mixer tab in the iConfig software. In addition, check that the output source you're monitoring is routed correctly in the Audio Patchbay tab.

MIDI is not being received by the expected destination

Please check the routing in the iConfig software MIDI Port Routing tab.

No sound from an iPad's speaker/earphones/microphone

The iOS device automatically uses the iConnectAUDIO2+ when it's connected. This deactivates the built-in speaker, usually the built-in mic, and often the headphones and/or headset mic when it's plugged into the device's 1/8" TRRS jack.

iPad's device's battery isn't charging

Please purchase the optional Power Supply! There isn't enough power available on the USB bus to power the device and charge an iPad.

Audio Specifications

Digital Performance

24-bit resolution

A-D Dynamic Range: 102dB (fs=49kHz, 20Hz - 20kHz A-25, 24 bit)

D-A Dynamic Range: 104dB (fs=44.1kHz, 20Hz - 20kHz, A-wt, 24 bit)

Supported sample rates: 44.1 kHz, 48 kHz, 88.2kHz, 96 kHz

Microphone Inputs

Gain: 0- 60 dB (1 dB steps)

Frequency Response (flatness): 20 Hz - 20kHz (+/- 0.02 dB)

SNR: +104 dB (1kHz, 1 Vrms, 22Hz-22kHz, A-wt, lowest gain)

THD+N: -90 dB (1kHz, 1 Vrms, 22Hz-22kHz, A-wt, lowest gain)

Line/Instrument Inputs (Balanced Input)

Attenuator: 20 dB (fixed)

Impedance: 800kOhms (Hi-Z), 45 kOhms (Lo-Z)

Frequency Response: 20 Hz - 20kHz

SNR: +104 dB (1kHz, 2 Vrms, 22Hz-22kHz, A-wt)

THD+N: -88 dB (1kHz, 2 Vrms, 22Hz-22kHz, A-wt)

Maximum input level: 8 Vrms, 20 dBu, 18 dBV (1kHz, 22Hz-22kHz, A-wt, 1% THD+N, SNR=+116 dB)

Line/Instrument Inputs (Single-Ended Input)

Attenuator: 20dB (fixed)

Impedance: 800kOhms (Hi-Z), 45kOhms (Lo-Z)

SNR: +104 dB (1kHz, 2 Vrms, 22Hz-22kHz, A-wt)

THD+N: -88 dB (1kHz, 2 Vrms, 22Hz-22kHz, A-wt)

Maximum input level: 8 Vrms, 20 dBu, 18 dBV (1kHz, 22Hz-22kHz, A-wt, 1% THD+N, SNR= +116dB dB)

Line Outputs

Maximum Output Level: 3.1 Vrms, 12 dBu, 9.8 dBV

Frequency response (flatness): 20 Hz - 20 kHz (+/- 0.1 dB)

SNR: +98 dB (1kHz, 22Hz-22kHz, A-wt)

THD+N: -98 dB (1kHz, 22Hz-22kHz, A-wt)

Headphone

Frequency response (flatness): 20 Hz - 20 kHz (+/- 0.1 dB)

SNR: +100 dB (1kHz, 22Hz-22kHz, A-wt)

THD+N: -99 dB (1kHz, 22Hz-22kHz, A-wt)

Power output into 30 Ohms per channel: 34 mW per channel

Features of iConnectAUDIO2+ are patent pending. For more details see www.iConnectivity.com/patents.

Product features are subject to change.

iPad is a trademark of Apple Inc., registered in the U.S. and other countries.

iConnectivity, iConnectMIDI, iConnectAUDIO, and passThru are trademarks of iKingdom Corp. Copyright (c) iKingdom Corp. 2016

www.iConnectivity.com

support@iConnectivity.com

+1 403.457.1122

Monday to Friday 9:00 am to 5:00 pm (Mountain Time)

iConnectivity

#100, 925 26th Street NE

Calgary, AB T2A 6K8

Canada

