

monologue

MONOPHONIC ANALOGUE SYNTHESIZER

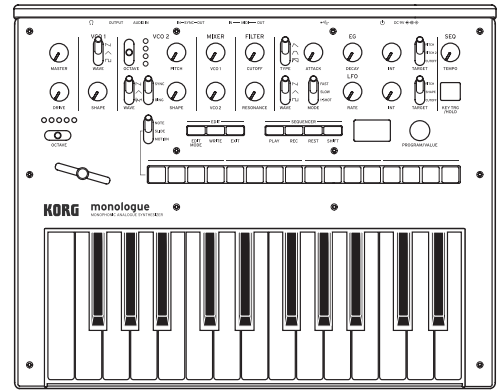

Owner's Manual

Table of contents

Introduction	2	Edit Mode	28
monologue Key Features	2	How to enter the Edit mode	28
Block Diagram	3	Edit Mode Parameter List	30
Controls and Connections	4	PROGRAM EDIT mode	31
Front Panel Controls	4	SEQ EDIT mode	35
Rear Panel Connections	5	GLOBAL EDIT mode	38
Turning the monologue On and Off	6	Other functions	46
Playing Programs and Sequences	9	Tuning	46
Selecting and Playing a Program	9	Restoring the Factory settings	48
Playing the Sequencer	10	Shortcuts using the SHIFT button	49
Programs	12	Understanding MIDI	50
Program Architecture	12	Connecting Devices via MIDI and USB	50
Creating Sounds	13	MIDI-Related Settings	52
Saving a Program	14	Program List	54
Basic Parameter Editing	15	Specifications	55
Sequencer	22	MIDI Implementation Chart	57
Mortion Sequence	24		

Introduction

monologue Key Features

- The monologue is a monophonic synthesizer, which features an analog synthesizer circuit based on the design of the popular minilogue.
- The VCF has been tuned for use in mono synths. Also, a drive circuit allows you to produce more aggressive sounds.
- The monologue is compact and lightweight, and can be powered by batteries, letting you enjoy making sound wherever you go.
- Instant recall of 80 factory presets plus 20 additional user programs.
- Real-time oscilloscope provides visual feedback of parameter changes.
- 16-step monophonic sequencer can automate up to 4 synth parameters.
- Sync In and Sync Out jacks allow you to expand your session setup.

Block Diagram

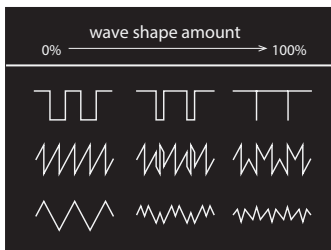
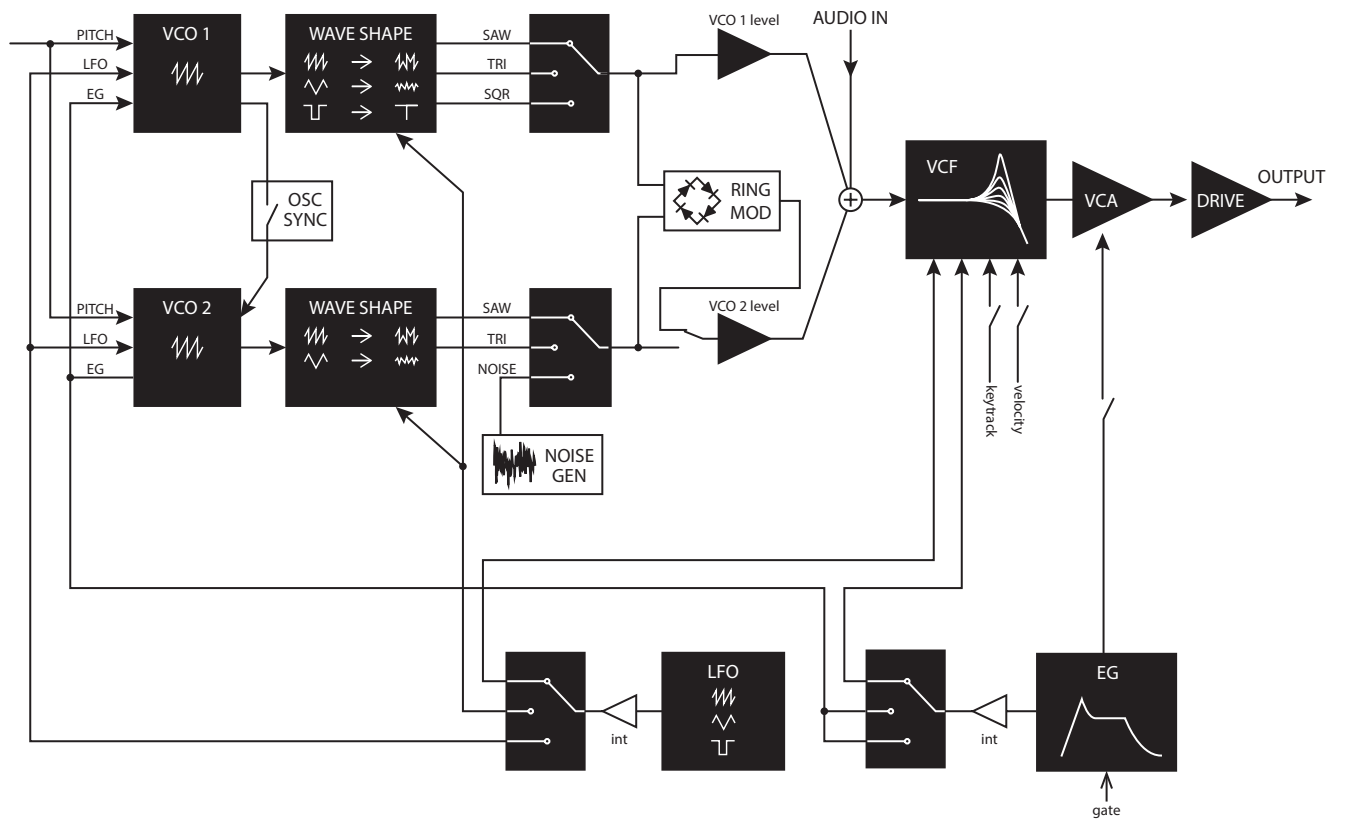

Controls and Connections

Front Panel Controls

This diagram shows the layout of the front panel knobs, switches, and buttons.

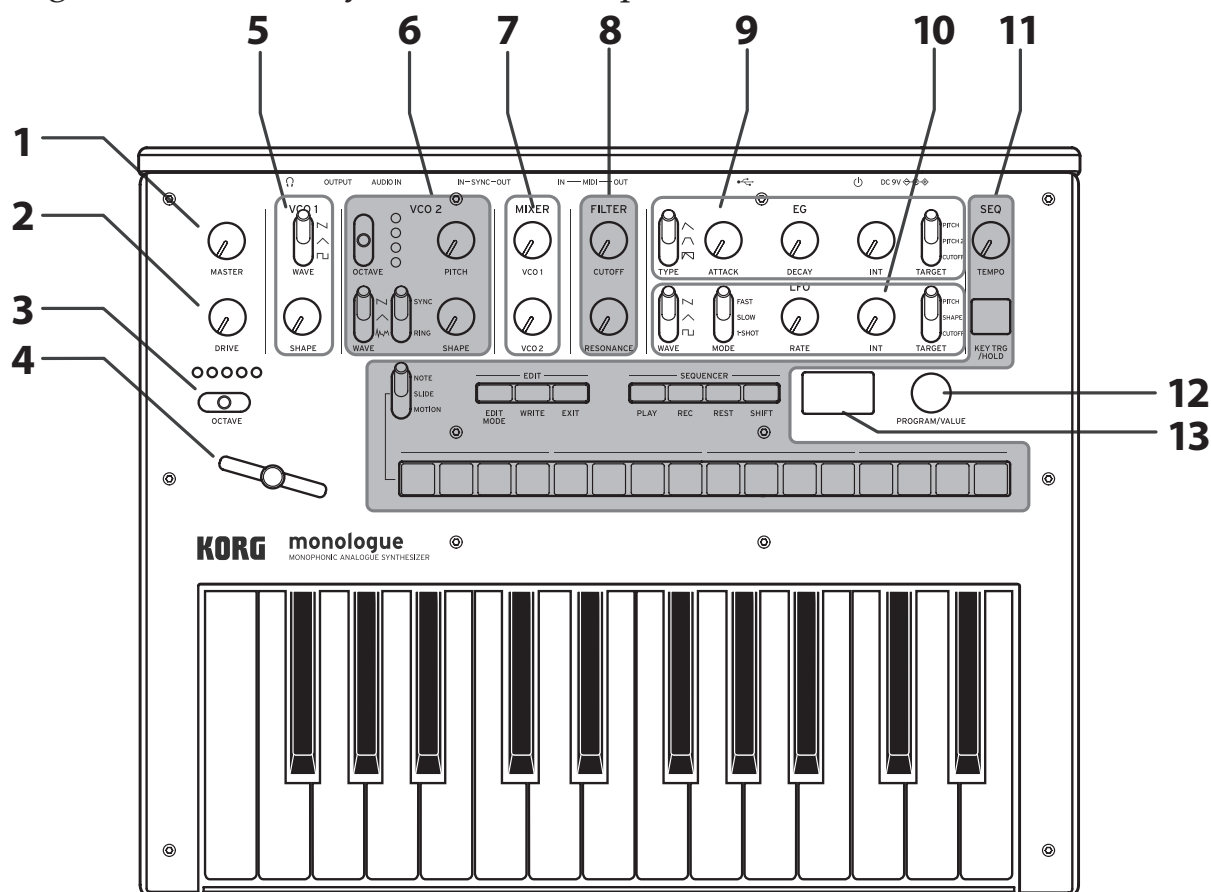

1. **MASTER knob**

2. **DRIVE knob**

3. **OCTAVE switch**

4. **Slider**

5. **VCO 1**

WAVE switch
SHAPE knob

6. **VCO 2**

OCTAVE switch
PITCH knob
WAVE switch
SYNC/RING switch
SHAPE knob

7. **MIXER**

VCO 1 knob
VCO 2 knob

8. **FILTER**

CUTOFF knob
RESONANCE knob

9. **EG**

TYPE switch
ATTACK knob
DECAY knob
INT knob
TARGET knob

10. **LFO**

WAVE switch
MODE switch
RATE knob
INT knob
TARGET switch

11. **SEQUENCER**

TEMPO knob
KEY TRG/HOLD button
MOTION/SLIDE/
NOTE switch
EDIT

EDIT MODE button
WRITE button
EXIT button

SEQUENCER

PLAY button
REC button
REST button
SHIFT button

Buttons 1-8

12. **PROGRAM/VALUE knob**

13. **Display**

Rear Panel Connections

The illustration below shows a typical example of connections for the monologue. Connect your equipment according to the needs of your own system.

- ⚠ Be sure that the power on all of your devices is turned off before you make connections. Leaving the power on when you make connections may cause malfunctions, or damage your speaker system and other components.

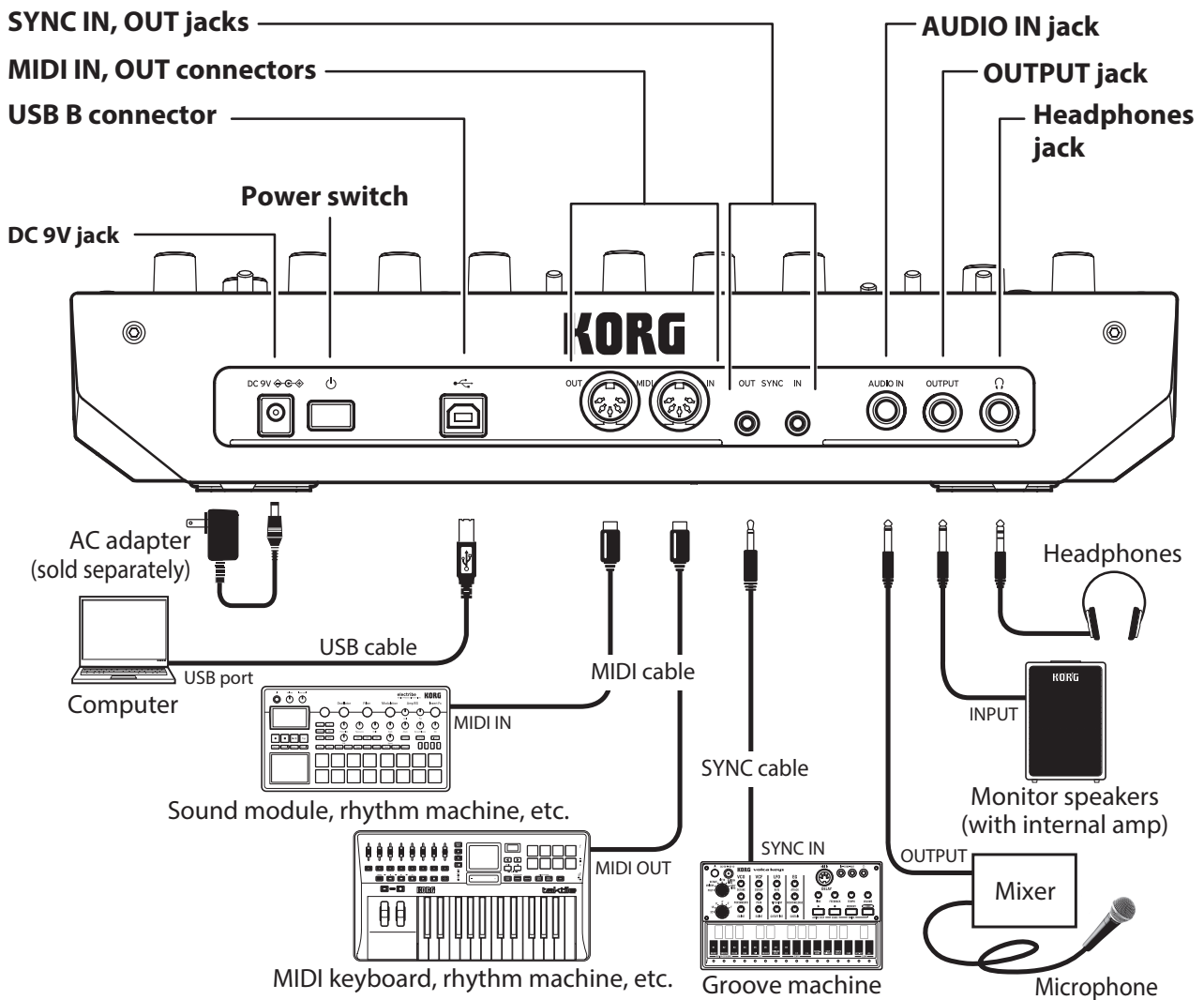

Connecting to audio devices

- Connect your powered monitor speaker, mixer or other components to the OUTPUT jack (monaural output) of the monologue. Adjust the volume level using the MASTER knob.
- Connect your headphones to the headphones jack. This jack outputs the same signal as that of the OUTPUT jack.
- Connect external sound sources, such as another synthesizer, to the AUDIO IN jack (monaural input).

Connecting to a computer or MIDI devices

- To exchange MIDI messages with your computer, connect your computer to the USB B connector on the monologue.
- To exchange MIDI messages with an external MIDI device, connect the device to the MIDI IN/OUT connectors on the monologue.

TIP For details, refer to “Understanding MIDI” (p. 50)

Connecting the SYNC IN and OUT jacks

- Use the SYNC IN and OUT jacks of the monologue when you want to synchronize to the output pulses and steps from the audio output jacks of sources such as the Korg volca series or a DAW. Connect using a Sync cable.
- The SYNC OUT jack sends a 5 V pulse of 15 ms at the beginning of each step.

TIP Refer to “Button 5 (GLOBAL 3)” (p. 41) of GLOBAL EDIT mode for the settings to turn on the monologue.

Turning the monologue On and Off

Before you turn the monologue On:

Installing batteries

Make sure that the monologue’s power is turned off.

1. **Open the battery cover on the monologue’s bottom panel.**
While pressing the latch, pull upward and remove.
2. **Insert six AA batteries, taking care to observe the correct polarity (+/- orientation).**
Use alkaline or nickel-metal hydride batteries.

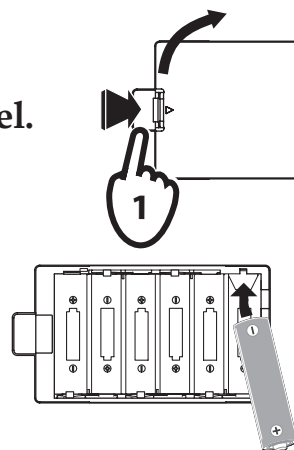

3. **Reattach the battery cover.**

▲ In order for the remaining battery amount to be detected and shown correctly, you must use the parameter in GLOBAL EDIT mode to specify the type of batteries that you’re using. By default, this setting is set to “Alkaline.” For details, refer to “Battery Type” (p. 43).

When the batteries become depleted, “Battery Low” will appear on the display. When this occurs, it’s time to replace the batteries.

▲ Remove old batteries immediately. Otherwise, battery leakage may occur, resulting in a malfunction. If you don’t think that you’ll be using the unit for a long period of time, you should remove the batteries.

TIP The monologue can also be used with the separately sold AC adapter connected to the DC 9V jack.

- 4. Make sure that any external output devices such as powered monitor speakers are turned off before connecting them to the monologue.**

TIP If you want to connect a MIDI device or computer to the monologue's MIDI connectors or USB B connector in order to use the monologue's keyboard and controllers to control an external MIDI tone generator, or if you want to use another MIDI keyboard or a sequencer to play the monologue's sound generator, you will need to configure the settings. For details, refer to "Understanding MIDI" (p. 50).

Turning the monologue On

- 1. Make sure that both the monologue and any external output devices such as powered monitor speakers are turned off, and turn the volume of all devices all the way down.**
- 2. Hold down the Power switch on the rear panel of the monologue; once the "monologue" logo appears in the display, take your finger off the Power switch.**
- 3. Turn on any external output devices such as powered monitor speakers.**
- 4. Adjust the volume of your external output equipment, and adjust the monologue's volume using the MASTER knob.**

Turning the monologue Off

Any Program data in the monologue that has not been saved will be lost when the power is turned off. Be sure to save any Program and other important data that you have edited ("Saving a Program", p. 14).

- 1. Turn the MASTER knob of the monologue to the left to turn the volume all the way down.**
Also, turn the volume all the way down on any external output devices that might be connected, such as powered monitor speakers.
- 2. Hold down the Power switch on the rear panel of the monologue; to turn off the power after the display goes blank, take your finger off the power switch.**
 Once you have turned the monologue off, wait about 10 seconds before turning the monologue on again.

Auto Power Off Feature

The monologue features an Auto Power Off feature that can automatically turn the monologue off after 4 hours have elapsed with no operation of the knobs, switches, buttons, or keyboard of the monologue. By default, the factory setting for the Auto Power Off is enabled. The Auto Power Off can be disabled using the steps below.

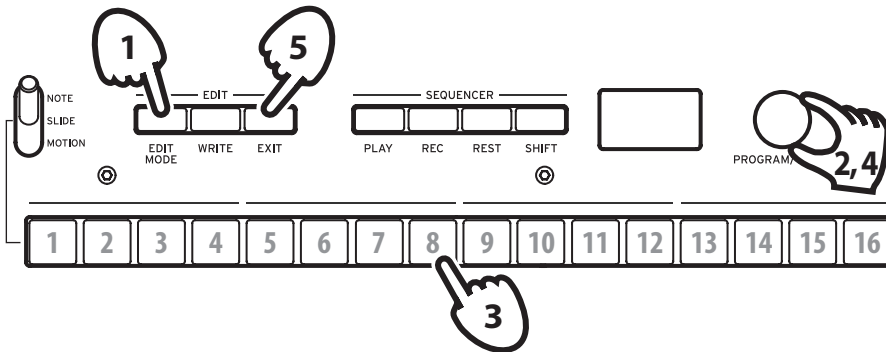

1. Press the EDIT MODE button.

The monologue will enter the Edit Mode, and the display will look like the illustration shown below.



2. Turn the PROGRAM/VALUE knob, and select GLOBAL EDIT.

TIP GLOBAL EDIT can also be selected by pressing the EDIT MODE button.

3. Press button 8 twice.

“Auto Power Off” will be displayed.

4. Turn the PROGRAM/VALUE knob, and select “Off”.

5. Press the EXIT button.

The monologue will enter the Play mode, and the display will indicate the current Program.

TIP Settings in GLOBAL EDIT are saved automatically.

Playing Programs and Sequences

Selecting and Playing a Program

The monologue comes equipped with 100 Programs. Of those, 80 are ready-to-play preset Programs and 20 locations are available to save your own sounds and custom edits.

Each Program includes settings for the sound, as well as sequence data settings.

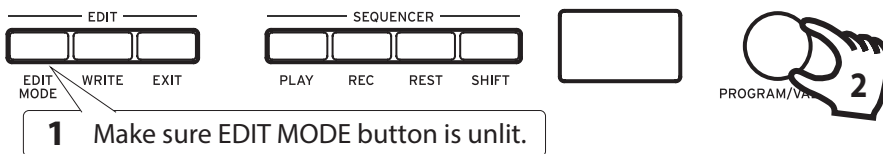

1. Enter the Play mode.

When the monologue is turned on, it will automatically enter the Play mode.

In the Play mode, verify that the EDIT MODE button on the front panel are unlit.

TIP If the EDIT MODE button is lit, press the EXIT button. The PLAY or REC buttons will light to indicate when the sequence data saved in a Program is being played back or is recording. You can still select other Programs in this state, but press the PLAY button if you wish to stop the Sequencer.

2. Turn the PROGRAM/VALUE knob to select a Program.

The display will indicate the Program name and number.



The monologue comes with 80 preset Programs (001–080) as part of the factory preload data. These preset Programs are instantly accessible and ready for you to enjoy. For details, refer to “Program List” (p. 54).

TIP Hold down the SHIFT button while turning the PROGRAM/VALUE knob to skip through the Program List in increments of 10.

TIP In addition to showing Program name and number, the display can also be used as an **oscilloscope**, to show the electrical signals created by the waveform of the sound. When SLIDE or NOTE is selected using the MOTION/SLIDE/NOTE switch, the waveform will be displayed.

3. Adjusting the OCTAVE range and the DRIVE knob, and the using the Slider.

As you play, you can use the five-way OCTAVE Switch to transpose the playing area of the keyboard by ± 2 octaves.

Turn the DRIVE knob to adjust the drive effect, which adds harmonics and distortion to the sound.

In addition, you can move the Slider from left to right to add real-time performance control.

TIP The parameter assigned to the slider will vary depending on the Program. Refer to “Program List” (p. 54) to see which parameter is assigned to the slider in each Program.

TIP The Slider Assign function in PROGRAM EDIT mode is used to assign parameters to the slider (“Slider Assign”, p. 31).

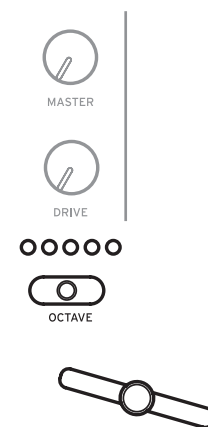

Playing the Sequencer

Each Program in the monologue includes sequence data. In this section, we'll play the sequence data saved as part of the preset Programs.

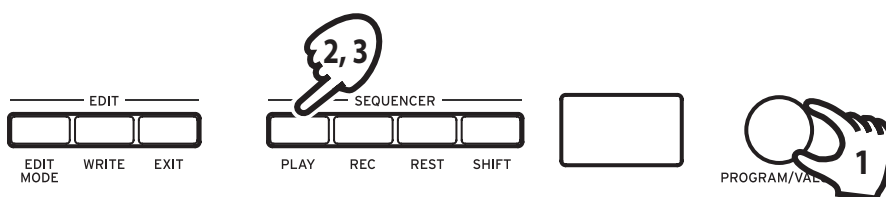

1. Turn the PROGRAM/VALUE knob to select a Program.

The display will indicate the Program name and number.

2. Press the PLAY button in the SEQUENCER section.

The sequence data that is recorded in the current Program will begin playing. The 1–16 buttons will light up in steps while the sequencer is playing.

TIP If you press the KEY TRG/HOLD button (the button will stay lit) instead of the PLAY button and then play the keyboard, the sequence data will play back while a key is being pressed. If you hold down the KEY TRG/HOLD button (the button will begin to blink) and then play the keyboard, the sequence data will keep playing back, even after you take your hand off the keyboard. Press a different key on the keyboard while holding down the KEY TRG/HOLD button as it lights or flashes, to play back the sequence data transposed.

TIP The Sequencer tempo is set for each Program in the SEQ EDIT mode and saved as part of the Program, but you can adjust the tempo from 56.0 to 240.0 BPM (Beats Per Minute) by turning the TEMPO knob.

3. Press the PLAY button once more to end the Sequencer playback.

Programs

Program Architecture

Each monologue Program includes settings for the Oscillators, Mixer, Filter, EGs and LFO, as well as a 16-Step Sequencer plus Effects.

Try editing each related parameter, and enjoy changing the sounds of the monologue.

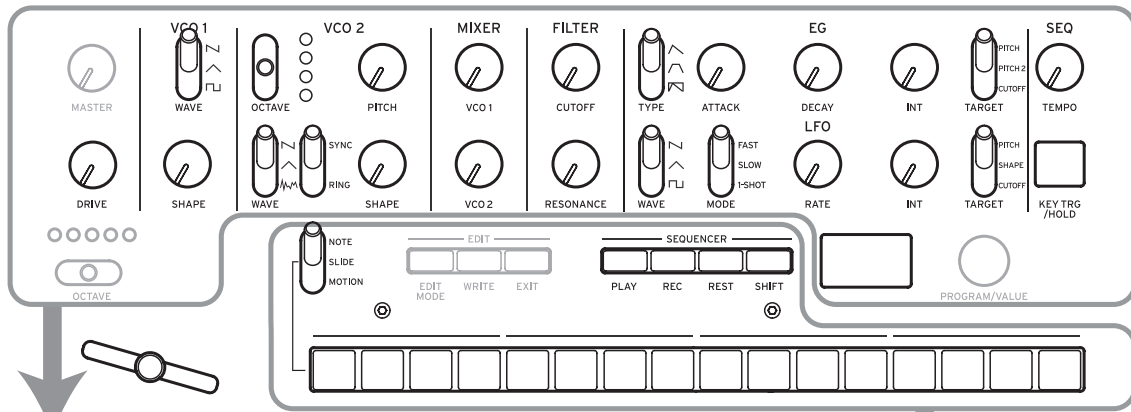

Basic Parametres

MASTER DRIVE	MIXER VCO1 VCO2	LFO WAVE MODE RATE INT TARGET
VCO 1 WAVE SHAPE	FILTER CUTOFF RESONANCE	LSEQ TEMPO KEY TRG/HOLD
VCO 2 OCTAVE WAVE SYNC/RING SHAPE	EG TYPE ATTACK DECAY INT TARGET	

Detail Parametres

Portamento Time Portamento Mode Slide Time	Microtuning Scale Key Program Tuning	Program Name
Slider Assign Bend Range + Bend Range -	LFO BPM Sync Cutoff Key Track Cutoff Velocity Amp Velocity Program Level	

Sequence Data

NOTE [STEP 1-16]
 GATE TIME [STEP 1-16]

NOTE ON/OFF [STEP1-16]
 SLIDE ON/OFF [STEP1-16]
 MOTION ON/OFF [STEP1-16]

Sequence Parameters

BPM

Step Length
 Step Resolution
 Swing
 Default Gate Time

Motion Enable (1-4)
 Motion Smooth (1-4)

Creating Sounds

Editing a program means changing the Program's parameters to alter its sound.

There are two way to create sounds on the monologue.

- Select an existing Program that's close to the sound you want, and edit that Program's parameters to achieve your own custom sound.
- You can also initialize all the Program parameters or use the Panel Load function to create your own sound from scratch.

Editing an Existing Program

1. **In Program mode, select the Program that you want to use as a starting point.**
2. **Use the knobs and switches on the front panel.**

Take a moment to consider the differences between the current Program and the sound you have in mind, and use the front panel controls to edit the necessary parameters.

TIP For details on how the pitch, sound, and volume change when using the knobs and switches, refer to "Basic Parameter Editing" (p. 15).

▲ We recommend that you save the Program on the monologue after editing the sound. Any edits that you make will be lost if you turn off the power or recall a different Program. For details, refer to "Saving a Program" (p. 14).

Creating a Program from Scratch

To create a sound from scratch, we recommend that you use the **Panel Load function**. This will load the current settings of each front panel control and provide a simple starting point for your iconic creations.

As you explore the front panel controls, you can see how each parameter will affect the sound, making it easier to understand how each section of the monologue functions and how the parameters interact.

Panel Load function

When the PLAY button is pressed while holding down the SHIFT button, the panel load function will be enabled. The sound will change to reflect the panel settings, and "Load Panel" will be indicated on the display.

Saving a Program

We recommend that you save your Program on the monologue after editing the sound.

⚠ Any edits that you make to the current program will be lost if you turn off the power or recall a different program before saving.

1. Edit the program in Play mode.

For details, refer to “Basic Parameter Editing” (p. 15).

2. Press the WRITE button; the monologue will enter the Write standby mode, and the WRITE button will blink.

The message “Where to write?” will appear in the display.

3. Turn the PROGRAM/VALUE knob to select the Program number where your new sound will be saved.

TIP Press the EXIT button to cancel the operation.

4. Press the WRITE button once more.

The Program will be saved in internal memory, and the message “Complete” will appear in the display.

⚠ Never turn off the power while Programs are being saved. Doing so may destroy the internal data.

Basic Parameter Editing

In this section, we'll explain the basic parameters that make up a program. The basic parameters are assigned to the knobs and switches on the front panel.

VCO 1, VCO 2

VCO: Voltage Controlled Oscillator

There are two oscillators in the monologue. Oscillator Parameters include the settings for the pitch of the sound (OCTAVE, PITCH) and the waveform (WAVE, SHAPE).

The PITCH for VCO 1 is locked to the main OCTAVE switch. The tuning for the entire keyboard is set using "Master Tune" in GLOBAL EDIT mode. For details, refer to "Master Tune" (p. 38).

VCO 1

WAVE switch [N, ^, □]

This sets the waveforms for Oscillator 1.

Sawtooth wave: This waveform is used to create sounds typical of analog synthesizers, such as synth basses and brass.

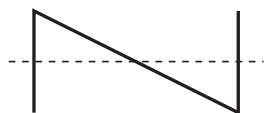

Triangle wave: This waveform has a rounder feel than the sawtooth or square wave.

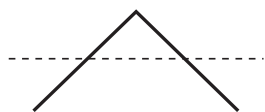

Square wave: This waveform is used for electronic and wind instrument sounds.

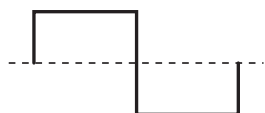

SHAPE knob

[0...1023]

This knob will determine the final shape, complexity, or duty-cycle (Square) of the selected waveform.

0 —————> 1023

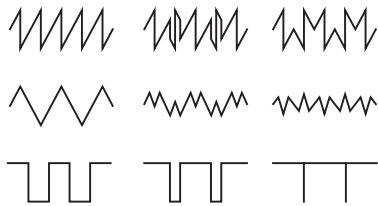

VCO 2

OCTAVE switch

[16', 8', 4', 2']

The pitch of Oscillator 2 can be set in octave steps.

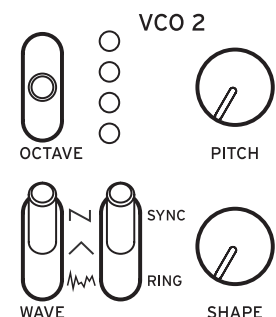

PITCH knob

[-1200...+1200]

The pitch, or tuning, of the Oscillator 2 can be set using one-cent steps.

TIP Turning the PITCH knob while holding the SHIFT button will change the tuning by semitones (100 cents).

WAVE switch

[>, ^, ~]

This sets the waveforms for Oscillator 2.

Sawtooth wave: This waveform is used to create sounds typical of analog synthesizers, such as synth basses and brass.

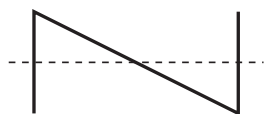

Triangle wave: This waveform has a rounder feel than the sawtooth or square wave.

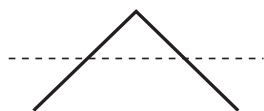

Noise wave: This waveform can be used on its own, or mixed with the Oscillator to create percussion instrument sounds, or sound effects such as surf.



RING/SYNC switch [OFF, ON]

This switch turns the Oscillator sync and ring modulator on or off. When the switch is in the center position, both the oscillator sync and the ring modulator will be turned off.

SYNC: With this type of modulation, the phase of Oscillator 2 is forcibly synchronized to the phase of Oscillator 1. This adds harmonic overtones to the frequency of Oscillator 2, making a complex waveform.

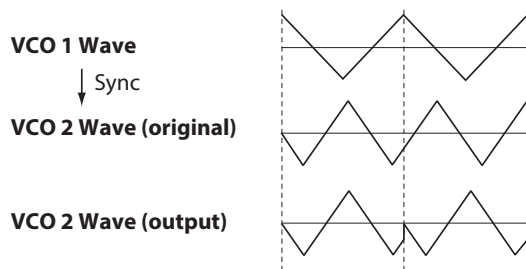

RING: This produces a ring modulation effect. Oscillator 1 is used to ring-modulate Oscillator 2. By adjusting the PITCH knob of Oscillator 2, you can create non-tonal metallic sounds.

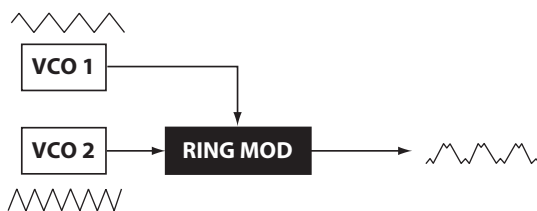

SHAPE knob [0...1023]

This knob will determine the final shape, complexity, or duty-cycle (Square) of the selected waveform.

0 —————> 1023



MIXER

The mixer is used to set the relative levels of Oscillators 1 and 2.

VCO 1 knob [0...1023]

VCO 2 knob [0...1023]

These knobs control the output levels of Oscillators 1 and 2.

MIXER



VCO 1



VCO 2

FILTER

VCF: Voltage Controlled Filter

The low-pass filter shapes the tone by selectively filtering certain parts of the harmonic spectrum of the sound generated by the Oscillators and the Noise generator.

CUTOFF knob [0...1023]

This knob is used to set the cutoff frequency. Harmonic content above the cutoff frequency will be filtered out.

Turning the knob to the left will lower the cutoff frequency, and turning the knob to the right will raise the cutoff frequency.

- ⚠ If the CUTOFF value is set too low, the volume may be extremely low.

FILTER



CUTOFF



RESONANCE

RESONANCE knob [0...1023]

Also known as Peak or Q, the RESONANCE control adds additional emphasis to the overtones occurring at the CUTOFF frequency, giving a distinctive character to the sound.

Turning the knob to the right will increase the resonance effect.

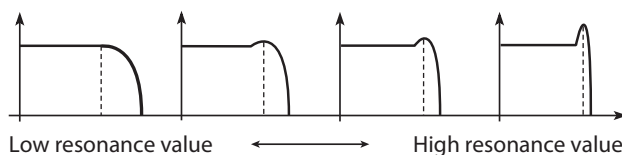

- TIP** The overtones that are emphasized will change depending on the cutoff frequency. For this reason, it's good to adjust the CUTOFF knob while adjusting the RESONANCE knob.

- ⚠ When emphasizing the overtones in this way, the sound may distort depending on the cutoff frequency or the input audio.

EG

EG: Envelope Generator

You can make time-based changes to the VCA, pitch or cutoff by using the EG.



TYPE switch [^, /, ▽]

The settings made here will change the VCA and TARGET parameters over time, as shown below.

When using GATE, time-based changes cannot be made to the VCA.

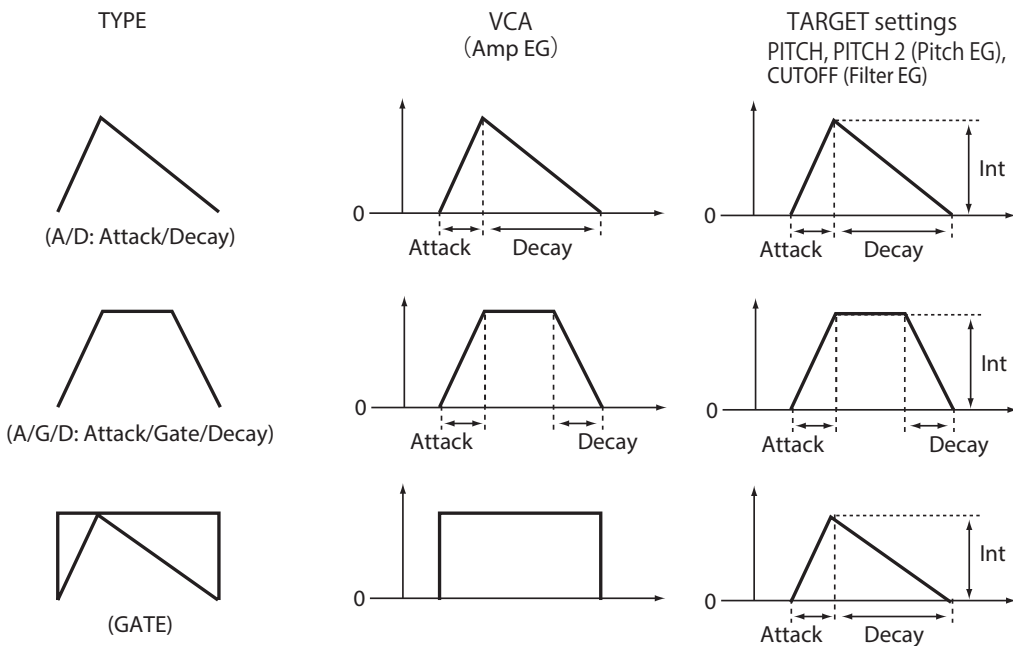

ATTACK knob [0...1023]

The ATTACK specifies the time required for the EG to reach its maximum level once a new note is played.

DECAY knob [0...1023]

When the TYPE switch is set to "A/D" or "GATE", this sets the amount of time until the level becomes 0 after the maximum level is reached.

When the TYPE switch is set to "A/G/D", this sets the time from note-off (when the key is released) until the level reaches 0.

INT knob **[-511...0...+511]**

Specifies the intensity of the EG.

Turning the knob to the right will increase the intensity.

TIP When turning the INT knob while holding down the SHIFT button, the effect will move in a negative direction.

TARGET switch **[PITCH, PITCH 2, CUTOFF]**

Selects which parameter will be affected by the EG.

PITCH: The EG will affect the PITCH of VCO 1 and VCO 2.

PITCH 2: The EG will affect the PITCH of VCO 2.

CUTOFF: The EG will affect the CUTOFF of the FILTER.

LFO

LFO: Low Frequency Oscillator

The LFO (low-frequency oscillator) is used to make cyclical changes in the pitch and volume of the sound.

Depending on its target, the LFO

can provide vibrato (PITCH); Tonal

changes to the Oscillators (SHAPE); or Wah-Wah (CUTOFF) effects.



WAVE switch **[\sawtooth , \triangle , \square]**

The LFO can be set to a sawtooth wave (\sawtooth), a triangle wave (\triangle), or a square wave (\square).

MODE switch **[FAST, SLOW, 1-SHOT]**

Specifies the range of change and action for the LFO frequency.

FAST: The range of speed for the LFO frequency will be from 0.5 Hz–2.8 kHz.

SLOW: The range of speed for the LFO frequency will be from 0.05 Hz–28 Hz.

1-SHOT: The LFO will stop one half-cycle after a sound is made. The range of speed for the LFO frequency will be from 0.05 Hz–28 Hz.

RATE knob

[0...1023 / 1/8, 1/16, 1/32...1/1024, 1/2048 / 4, 2, 1, 0, 3/4...1/64]

The rate knob adjusts the speed of the LFO.

Turning the knob to the right will increase the LFO speed.

The values indicated here depend on the LFO BPM Sync (p.33) settings in the PROGRAM EDIT mode, and the MODE switch, as shown below.

LFO BPM Sync	MODE switch	
Off		0-1023
On	FAST	1/8, 1/16, 1/32...1/1024, 1/2048
On	SLOW, 1-SHOT	4-1/64

TIP When the Parameter Disp of GLOBAL EDIT mode is set to All, you can see the value ("Parameter Disp", p. 43).

INT knob

[0...1023]

The INT knob adjusts the intensity of the LFO.

Turning the knob to the right will increase the LFO intensity.

TIP When turning the INT knob while holding down the SHIFT button, the effect will move in a negative direction.

TARGET switch

[PITCH, SHAPE, CUTOFF]

Selects the parameter where the LFO modulation will be applied.

PITCH: Modulation is applied to the VCO 1, 2 PITCH.

SHAPE: Modulation is applied to the VCO 1, 2 SHAPE.

CUTOFF: Modulation is applied to the FILTER CUTOFF.

Sequencer

In this section, we'll explore real-time recording, step recording, and motion sequence recording, as well as how to edit the recorded sequences (step edit).

Real-Time Recording

Recording a performance

This feature allows you to record your performance on the monologue keyboard in real time.

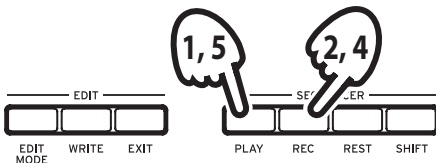

- 1. Press the PLAY button in the SEQUENCER section to play the sequencer.**
The PLAY button will light.
- 2. Press the REC button.**
Real-time recording will begin, and the REC button will light.
- 3. Play the keyboard.**
The notes that you play on the keyboard will be overdubbed (added to the recording of the sequence data).
- 4. Press the REC button once more to stop the recording.**
The REC button will go dark.
TIP Press the REC button once more to start recording again.
- 5. Press the PLAY button to finish real-time recording.**
The PLAY button will go dark.

Deleting the sequencer data

Press the REST button to erase or delete existing notes in the sequence during real-time recording.

Step Recording

1. **Press the REC button in the SEQUENCER section while the sequencer is stopped.**

“STEP REC” and “STEP 1” will be indicated in the display.

If the sequence has already been recorded, the note names will be indicated in the display.

TIP Select the step you wish to edit. For instance, use button 3 to select step 3.

2. **Use the keyboard, REST button and other controls to edit the notes.**

When you record a note, rest, or tie in step mode, the display will automatically move to the next step.

Recording notes

The note name for the keys you press on the keyboard will be indicated in the display. Check the note name in the display, and if it is correct, release your finger to record that note and to move to the next step.

If the note name is not correct, just play the correct key while continuing to hold down the wrong key. Check the note indicated in the display, and take your finger off the keyboard to move to the next step.

TIP The note length during recording is determined by the Default Gate Time value that is set in the SEQ EDIT mode. If you turn the PROGRAM/ VALUE knob while playing the keyboard, the gate time for only the note(s) you played will be changed when recording.

Recording a rest

You can record a rest by pressing the REST button.

Recording a tie

Press the REST button while holding down a key. The note will be tied to the next note and recorded.

3. **When the set number of steps have finished recording, step recording will automatically end. Pressing the REC button at any step during recording will stop the step recording at that step.**

TIP The number of steps is set for each Program, and you can change the number of steps using the Step Length function in the SEQ EDIT mode. For details, refer to “Step Length” (p. 35). Turn the PROGRAM/VALUE knob during step recording to change the Step Length.

Motion Sequence

Recording a Motion Sequence

Motion Sequencing allows you to record the flipping of switches and the turning of knobs as part of the sequence, and recreate those motions automatically during playback.

Four Motion Sequences can be recorded on the monologue, which can include changes to all knobs and switches (except for the MASTER knob, TEMPO knob, and OCTAVE switches).

1. Press the **PLAY** button to play the sequencer.
2. Set the **MOTION/SLIDE/NOTE** switch to **MOTION**.
"MOTION VIEW" will be shown on the display, and the motion that is saved to the program will be graphically displayed.

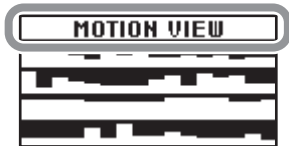

3. Press the **REC** button.
Real-time recording will begin.
4. **Move the knobs and switches on the monologue.**
A Motion Sequence of the knobs and switches you moved will be recorded. You can record up to 4 Motion Sequences for the knobs and switches.
If you exceed this limit, the message "Motion Full" will be indicated in the display, and the display will enter MOTION CLEAR in the SEQ EDIT mode. When this happens, delete a previously-recorded Motion Sequence before recording a new one ("Deleting a Motion Sequence", p. 25).
5. **After the set number of steps have finished recording, the Motion Sequence will automatically finish recording as well.**
Start at step 3 to record motion sequences for other knobs and switches. When you record a motion sequence of the knobs and switches you moved, the previous data will be overwritten.
TIP The number of steps is set for each Program, and you can change the number of steps using the "Step Length" function in the SEQ EDIT mode. For details, refer to "Step Length" (p. 35).

Deleting a Motion Sequence

If you try to record a fifth Motion Sequence, the message “Motion Full” will be indicated in the display. When this happens, the display will enter MOTION CLEAR in the SEQ EDIT mode, and you will be able to delete one of the previously recorded Motion Sequences.

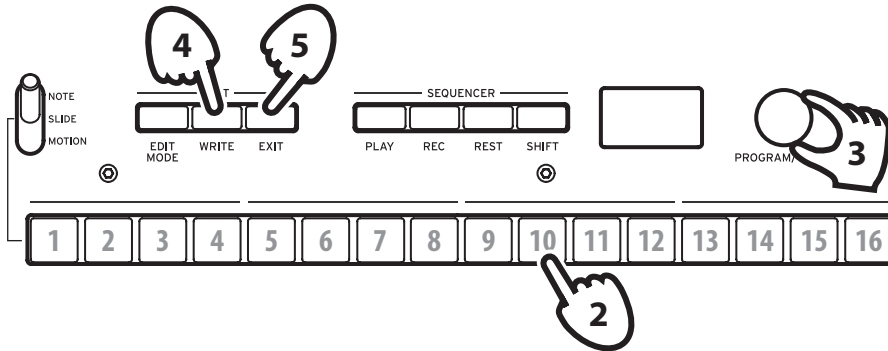

1. Check that the monologue is on the MOTION CLEAR function, in the SEQ EDIT mode.

“MOTION CLEAR” will be indicated in the display. You can delete Motion Sequences one at a time here.

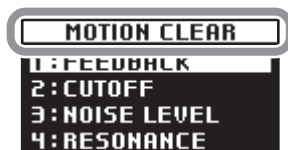

TIP Press the EXIT button to cancel deleting the Motion Sequence.

2. Press button 10, and select the motion to delete.
3. Turn the PROGRAM/VALUE knob to select the message “CLEAR...?”.
4. Press the WRITE button.
The selected Motion Sequence will be deleted.
5. Press the EXIT button.
6. To continue recording a Motion Sequence, press the REC button, and press the PLAY button to stop.

TIP To delete all Motion Sequences at once, use the “Motion Clear” function assigned to button 7 in the SEQ EDIT mode. For details, refer to “Motion Clear” (p. 36).

Editing sequence data (step edit)

With step edit, you can change and adjust notes, slides and motion sequences in the sequence data you record.

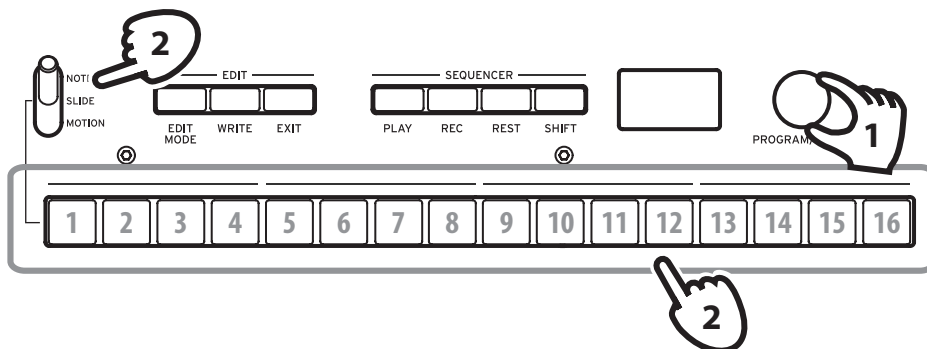

1. Select the program that includes the sequence data you wish to edit.
2. Edit the sequence data using the MOTION/SLIDE/NOTE switch and buttons 1–16.

When the MOTION/SLIDE/NOTE switch is set to NOTE

Pressing buttons 1–16 will turn the notes recorded for the corresponding steps on (the button will light) or off (the button will go dark). For steps that are turned on, the corresponding notes will play; and for steps that are turned off, the corresponding notes will not play (rest). If a note has not been recorded for a step, it cannot be turned on.

Hold down a button and press a key to input a note on the corresponding step. Holding down adjacent buttons together and then pressing a key will tie the notes belonging to those steps together.

TIP To adjust the gate time for the corresponding steps, turn the PROGRAM/VALUE knob while holding down the buttons.

When the MOTION/SLIDE/NOTE switch is set to SLIDE

Pressing buttons 1–16 will turn the slide for the corresponding steps on (the button will light) or off (the button will go dark).

When SLIDE is on for a particular step, a slide effect will be heard from that step to the next step. The intensity of the slide effect can be adjusted in PROGRAM EDIT mode. For details, refer to “Slide Time” (p. 31).

When the MOTION/SLIDE/NOTE switch is set to MOTION

“MOTION VIEW” will be shown on the display, and the motion that is saved to the program will be graphically displayed.

Pressing buttons 1–16 will turn the motion for the corresponding steps on (the button will light) or off (the button will go dark). If motion has not been recorded for a step, it cannot be turned on.

When a knob is turned while one button is held down, motion will be recorded for that step. When a knob is turned while multiple buttons are held down, a motion will be recorded for those steps.

For example, when turning the INT knob of the LFO to 50% while holding down buttons 3 and 5, the INT 50% setting for the LFO will be recorded on both steps 3 and 5. Although only continuous value changes can be recorded when recording a motion sequence with real-time recording, this function can be used to record motion changes for each step.

Press the REC button and move the knobs or switches during sequencer playback to record a motion sequence.

- 3. When the number of steps that are recorded are finished, editing will automatically stop.**

Other editing functions

Use the SEQ EDIT mode when setting the Step Length and Step Resolution parameters during sequence step recording, as well as for deleting sequence data, or for editing or deleting motions. For details, refer to “SEQ EDIT mode” (p. 35).

Edit Mode

Although nearly all of the monologue's main parameters can be edited using the knobs and switches on the panel, other detailed parameters are accessed using the **Edit mode**.

There are three sub-modes within the Edit mode: **PROGRAM EDIT mode**, **SEQ EDIT mode**, and **GLOBAL EDIT mode**.

How to enter the Edit mode

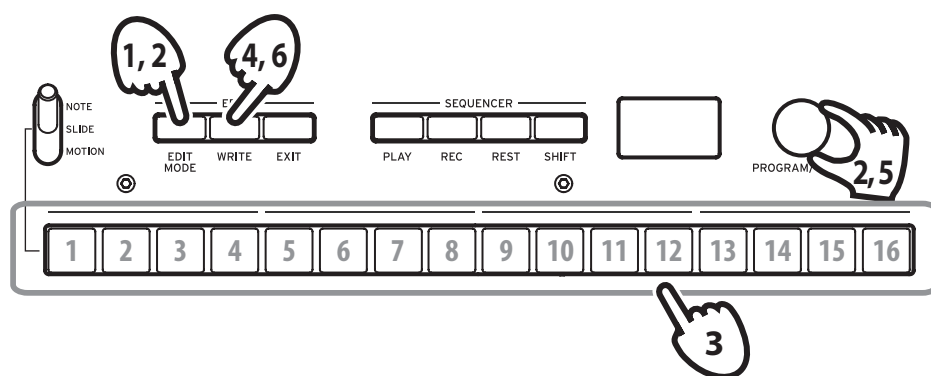

1. Press the EDIT MODE button.

Each Edit mode is shown in the display, and the buttons light.



2. Press the EDIT MODE button repeatedly—or use the PROGRAM/VALUE knob—to advance to the PROGRAM EDIT mode, SEQ EDIT mode, or GLOBAL EDIT mode.

PROGRAM EDIT mode: This mode is used to change the Program name and assign a parameter to the slider, as well as to initialize Programs and perform other Program editing functions.

SEQ EDIT mode: This mode is used to set the BPM and configure other Step Sequencer settings, to delete sequence data, and so on.

GLOBAL EDIT mode: This mode is used to set the tuning and to specify how the knobs and switches should function, as well as settings that affect the entire synthesizer—such as MIDI.

3. Press one of buttons 1–16 that are lit up.

The monologue will enter the respective Edit page, and the parameter names will be indicated on the display.

Switch to a different page by pressing the same button in succession.

Refer to “Edit Mode Parameter List” (p. 30) for a list of the parameters on each edit page.

4. After you have configured the parameters in PROGRAM EDIT mode and/or SEQ EDIT mode, press the WRITE button to save your changes.

The display will indicate the message “Where to write?”.

 If you do not save your changes and select another Program after you have configured the parameters in the PROGRAM EDIT mode and the SEQ EDIT mode, your settings will be lost.

TIP GLOBAL EDIT mode parameters are automatically saved when you switch pages, so there is no need to save them manually. Press the EXIT button to return to Play mode.

5. Use the PROGRAM/VALUE knob to select the destination Program number where you will save your edited sound.

Press the EXIT button to cancel the save operation and return to Play mode.

6. Press the WRITE button to save the settings and return to the Play mode.

Edit Mode Parameter List

Button	1	2	3	4	5	6	7	8	9	10	11	12	13	14	15	16	
PROGRAM EDIT mode					PORTAMENTO (p.31)	SLIDER FUNC (p.31)	PITCH SETTINGS (p.32)	OTHER SETTINGS (p.33)	PROGRAM NAME (p.34)			DUMP (p.35)					
					Portamento Time	Slider Assign	Microtuning	LFO BPM Sync	Program Name		Initialize	Program Dump					
					Portamento Mode	Bend Range +	Scale Key	CutoffKey Track									
					Slide Time	Bend Range -	Program Tuning	CutoffVelocity									
								Amp Velocity									
								Program Level									
						BPM (p.35)	SEQ PARAMETER (p.35)	SEQ CLEAR (p.36)		MOTION CLEAR (p.36)	MOTION ENABLE (p.37)	MOTION SMOOTH (p.37)					
					BPM	Step Length	All Clear			Motion 1...4	Motion 1...4	Motion 1...4					
						Step Resolution	Motion Clear										
					Swing												
					Default Gate Time												
GLOBAL EDIT mode		GLOBAL 1 (p.38)	GLOBAL 2 (p.38)	GLOBAL 3 (p.41)	GLOBAL 4 (p.42)	GLOBAL 5 (p.43)	GLOBAL 6 (p.43)			USER SCALE (p.44)	USER OCTAVE (p.44)	SCALE CLEAR (p.44)	SCALE DUMP (p.45)	ALL DUMP (p.45)			
		Master Tune	Metronome	Sync In Unit	MIDI Ch	Parameter Disp	Battery Type			USER SCALE 1...6	USER OCTAVE 1...6	USER SCALE 1...6	USER SCALE 1...6	All Dump (USB)			
		Transpose	Knob Mode	Sync Out Unit	Clock Source		Battery Type					USER OCTAVE 1...6	USER OCTAVE 1...6	All Dump (MIDI)			
			Audio In	Sync In Polarity	Enable Rx MIDI		Brightness										
			Local SW	Sync Out Polarity	En Rx Transport												
			Velocity Curve		Enable Tx MIDI												
					MIDI Route												

PROGRAM EDIT mode

Button 5 (PORTAMENTO)

Portamento Time [Off, 0...127]

Portamento produces a continuous glide in pitch between notes; this parameter controls the portamento time.

Off: No portamento effect is applied.

The larger the value, the longer the portamento time.

Portamento Mode [Auto, On]

Auto: When playing in a legato style (playing a new note before any previously played note is released), portamento will be applied.

On: Portamento will be applied, even when fully releasing a key and then playing the next note.

Slide Time [0%...100%]

This sets the length of the slide.

The larger the value, the longer the slide time.

Button 6 (SLIDER FUNC)

The Slider offers real-time control over a specific parameter of your choosing. In addition, the slider can be used as a pitch bend controller.

Slider Assign [PITCH BEND...PORTAMENTO]

You can assign any one these performance parameters to the slider:

- PITCH BEND
- GATE TIME
- VCO 1 PITCH
- VCO 1 SHAPE
- VCO 2 PITCH
- VCO 2 SHAPE
- VCO 1 LEVEL
- VCO 2 LEVEL
- CUTOFF
- RESONANCE
- EG INT
- ATTACK
- DECAY

LFO RATE
LFO INT
PORTAMENTO

Bend Range + [1 Note...12 Note]

If the Slider is set to PITCH BEND, this parameter specifies how much pitch bend will be applied when moving the slider in the plus (right) direction.

Bend Range - [1 Note...12 Note]

If the Slider is set to PITCH BEND, this parameter specifies how much pitch bend will be applied when moving the slider in the minus (left) direction.

Button 7 (PITCH SETTINGS)

Microtuning [Equal Temp...Reverse, AFX 001...006, USER SCALE 1...6, USER OCTAVE 1...6]

This sets the program's microtuning.

Preset tunings or user tunings that you have edited yourself can be selected.

Equal Temp (Equal Temperament): Spacing all semitones at equal pitch intervals, this temperament is the most widely used.

Pure Major: Major chords in the selected key are perfectly tuned.

Pure Minor: Minor chords in the selected key are perfectly tuned.

Pythagoras: This ancient Greek scale is especially effective for playing melodies. It consists of perfect fifths; however, other intervals—the major third in particular—is out of tune.

Werkmeister: The Werckmeister III scale was created in the later Baroque period to allow relatively free transposition.

Kirnberger: The Kirnberger III scale is used mainly for tuning harpsichords.

Slendro: This is an Indonesian gamelan scale with five notes per octave.

Pelog: This is an Indonesian gamelan scale with seven notes per octave.

Ionian: This is a major scale that contains seven notes per octave.

Dorian: This is the Aeolian scale (seven notes per octave) with a sharp sixth.

Aeolian: This is a natural minor scale that contains seven notes per octave.

Major Penta: This is a major pentatonic scale.

Minor Penta: This is a minor pentatonic scale.

Reverse: This is a reverse scale based on the C4 note.

AFX 001...006: These are original scales created by Aphex Twin, covering the entire tonal range.

USER SCALE 1...6: These are user-programmed scales with different settings for all MIDI notes. You can set them up in PROGRAM EDIT mode. For details, refer to "Microtuning function" (p. 46).

USER OCTAVE 1...6: These are user-programmed scales with settings for each of the 12 notes in an octave. You can set them up in PROGRAM EDIT mode. For details, refer to “Microtuning function” (p. 46).

Scale Key [-12 Note...+12 Note]

This sets the key for the scale set using microtuning.

The preset tunings are in the key of C, but you can use this scale key parameter to change the key to something besides C. For instance, if you want to change the key to “D”, set Scale Key to “+2”.

Note that this setting will be disabled when using “Equal Temp” microtuning.

Program Tuning [-50 Cent...+50 Cent]

Sets the tuning of the program in cents (1 semitone=100 cents), within a range of ±50 cents.

Button 8 (OTHER SETTINGS)

LFO BPM Sync [Off, On]

This function allows you to choose whether the LFO frequency will be synchronized with the BPM of the Sequencer.

Off: The LFO frequency will not be synchronized. When the LFO RATE knob is turned, the LFO Rate value changes continuously within the 0–1023 range (“RATE knob”, p. 21).

On: The LFO frequency will be synchronized. The LFO Rate value will change in a non-continuous manner when the LFO RATE knob is turned, depending on the LFO MODE switch settings (“MODE switch”, p. 20), (“RATE knob”, p. 21).

Cutoff Key Track [0%...100%]

Key tracking allows the note played on the keyboard to influence the cutoff frequency of the filter. This is useful when you want higher notes to have more upper harmonics, or to appear brighter, than lower notes.

0%: No keyboard tracking will be applied.

50%: The cutoff frequency will change at half the rate/slope as the pitch of the keyboard.

100%: The cutoff frequency will change at the same rate/slope as the pitch of the keyboard.

Cutoff Velocity [0%...100%]

Specifies how the velocity (keyboard playing dynamics) will affect the cutoff frequency, allowing louder notes to appear brighter, etc.

0%: Velocity will not affect the cutoff frequency.

50%: Velocity will affect the cutoff frequency, but at only half the amount produced at 100%.

100%: Playing the keys harder will increase the cutoff frequency, while playing the keys softer will decrease the cutoff frequency.

Amp Velocity [0...127]

Amp Velocity is used to specify how much the volume will change according to the keyboard velocity.

0: The velocity will not affect the volume.

The larger the value, the more effect that keyboard velocity will have on volume.

Program Level [-25...+25]

Program Level allows you to adjust the volume of a Program relative to other Programs.

Increasing this value will make the volume louder.

Button 9 (PROGRAM NAME)

You can create a Program Name up to 12 characters in length.

Rotate the PROGRAM/VALUE knob to select the desired character, then press button 1 to move the cursor to the next position.

Button 11 (INITIALIZE)

This button initializes the current Program.

Turn the PROGRAM/VALUE knob until "Press WRITE" is indicated in the display. The WRITE button will blink.

Press the WRITE button to initialize the Program. The display will indicate the message "Initialized".

Button 12 (DUMP)

This button initiates a Program dump.

Turn the PROGRAM/VALUE knob until “Press WRITE” is indicated in the display. The WRITE button will blink.

Press the WRITE button to send a SysEx Program dump from the monologue’s MIDI OUT and USB B connector. The display will indicate the message “Program Dump”.

SEQ EDIT mode

Button 5 (BPM)

BPM [10.0...600.0]

This parameter sets the tempo of the Sequencer in Beats Per Minute (BPM).

Button 6 (SEQ PARAMETER)

This group provides control of various Sequencer timing and resolution parameters such as Gate Time, Swing, etc.

Step Length [1...16]

Step Length allows you to set the number of steps used by the Step Sequencer.

TIP You can also set the number of steps by turning the PROGRAM/VALUE knob in step recording.

Step Resolution [1/16, 1/8, 1/4, 1/2, 1/1]

The Step Resolution is used to set the length of each Step Sequencer step.

1/16: A single step will be set to the length of a sixteenth note.

1/1: A single step will be set to the length of one measure. Use this when you want to play long chords.

Swing [-75%...+75%]

The Swing parameter adjusts the intensity of the swing.

Default Gate Time [0-100%]

The Gate Time is the default value used for each step recorded using the Step Sequencer. Lower values are more staccato, higher values have a longer gate time.

Button 7 (SEQ CLEAR)

This function provides a convenient way to erase all data within a specific sequence.

All Clear

When using All Clear, all notes and Motion Sequences contained within the sequence data will be deleted.

Turn the PROGRAM/VALUE knob until “Press WRITE” is indicated in the display. The WRITE button will blink.

Press the WRITE button to delete the data. The display will indicate the message “All Cleared”.

Motion Clear

With Motion Clear, only the Motion Sequences contained within the sequence data will be deleted.

Turn the PROGRAM/VALUE knob until “Press WRITE” is indicated in the display. The WRITE button will blink.

Press the WRITE button to delete all of the Motion Sequence data. The display will indicate the message “Motion Cleared”.

Button 10 (MOTION CLEAR)

MOTION CLEAR

Unlike the previous motion clear, button 7 allows you to clear motions 1–4 individually.

Press button 10 to select the Motion Sequence to delete.

Turn the PROGRAM/VALUE knob until “CLEAR...?” is indicated in the display. The WRITE button will blink.

Press the WRITE button to delete the data. The display will indicate the message “Cleared”.

TIP While the SHIFT button is pressed, the **MOTION VIEW** screen will be displayed, where you can see the waveforms for the Motion Sequences you have recorded.

Button 11 (MOTION ENABLE)

MOTION ENABLE [OFF, ON]

By setting this function to OFF, you can disable a particular motion without deleting the data.

Press button 11 to select the Motion Sequence to configure.

Turn the PROGRAM/VALUE knob, and select either "OFF" or "ON".

OFF: The Motion Sequence will be disabled, and the parameters will not change (the recorded Motion Sequence will not be deleted).

TIP While the SHIFT button is pressed, the **MOTION VIEW** screen will be displayed, where you can see the waveforms for the Motion Sequences you have recorded.

Button 12 (MOTION SMOOTH)

MOTION SMOOTH [OFF, ON]

The motion of a Motion Sequence can step from one value to the next, or it can transition smoothly from one value to the next by applying Motion Smooth.

Press button 12 to select the Motion Sequence to configure, and turn the PROGRAM/VALUE knob to select either "OFF" or "ON".

OFF: The Motion Sequence will make changes to the sound in steps.

ON: The Motion Sequence will change smoothly, and make smooth changes to the sound.

TIP While the SHIFT button is pressed, the **MOTION VIEW** screen will be displayed, where you can see the waveforms for the Motion Sequences you have recorded.

GLOBAL EDIT mode

GLOBAL EDIT functions apply to the entire monologue universally.

Button 3 (GLOBAL 1)

Common to both Oscillators, these functions control the tuning and transposition of the monologue.

Master Tune [-50 Cent...+50 Cent]

This adjusts the overall tuning of the entire monologue in one-cent units (semitone=100 cents), over a range of ± 50 cents.

0: A4 is equal to 440 Hz when the Microtuning is set to “Equal Temp”.

Transpose [-12 Note...+12 Note]

Transposing the keyboard allows you play in a different key using familiar fingerings on the keyboard.

Button 4 (GLOBAL 2)

These functions relate to performance aspects of the monologue—knob operation, local settings, and more.

Metronome [Off, On]

Sets whether the metronome will be played during real-time recording.

Knob Mode [Jump, Catch, Scale]

The front panel knobs can operate in one of three modes:

Jump: When you turn the knob, the parameter value will jump to the value indicated by the knob. Since this makes it easy to hear the results while editing, we recommend that you use this setting.

Catch: Turning the knob will not change the parameter value until the knob position matches the stored value. We recommend that you use this setting when you don't want the sound to change abruptly, such as while performing.

Scale: When you turn the knob, the parameter value will increase or decrease in a relative manner in the direction that it is turned. When you turn the knob and it reaches the full extent of its motion, it will operate proportionate to the maximum or minimum value of the parameter. Once the knob position matches the parameter value, the knob position and parameter value will subsequently be linked.

If the parameter value does not change

In some cases, the parameter value may not change or Motion Sequence recording may not start, even when you turn the knob. This means that the knob mode is set to “Catch”.

In this case, the actual value of the parameter you’re editing (the value shown in the display) will not change unless it matches the position of the knob. In Catch mode, the knob position and the value will be linked only after the knob position reaches the actual value. This prevents an unnatural change in sound that is caused when a value suddenly changes.

Let’s say that you’ve turned the knob to edit a certain parameter, and that the knob is in the position shown.



The actual value of the parameter is at the position shown by the triangle.

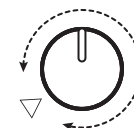

The parameter value will not change until the knob position reaches the triangle mark.

Once the knob has reached the position corresponding to the actual value, the parameter value and the knob position will be linked, and the value will change as you turn the knob.



Audio In [Off, On]

The audio input jack can be globally enabled or disabled.

Off: Any audio signals coming into the jack will be muted.

Local SW [Off, On]

The local connection makes a link between the monologue keyboard the sound-generating circuitry. Normally, this link is On. However, if you are using the monologue with an external sequencer or sequencing software, you will want to set the local connection to Off to eliminate the double-triggering of notes caused by MIDI echo.

Off: The monologue’s keyboard will be internally disconnected from the tone generator.

Velocity Curve

[Type 1...8, Const 127]

Changing the Velocity Curve allows you to match the dynamic response of the monologue keyboard to your own playing style and technique.

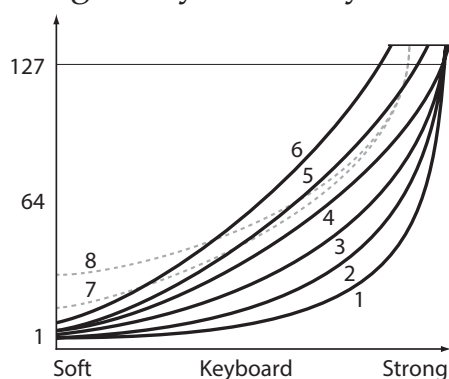

Type 1	This curve requires you to play strongly in order to produce an effect.
Type 2, 3	:
Type 4	This is a typical curve.
Type 5	:
Type 6	This curve produces an effect without requiring you to play very strongly.
Type 7	This curve produces a fairly steady effect with little change for medium-strength playing.
Type 8	This curve produces a fairly steady effect with little change for medium-strength playing (a flatter curve than 7).
Const 127	All notes will sound at maximum velocity.

Curve types 7 and 8 produce little change for medium-strength playing, and are suitable when keyboard velocity is not required, or when you want to play each note at the same velocity. However, these curves will produce a great deal of change with softly played notes, so the sound may be more difficult to control. Choose the curve that is most appropriate for your playing dynamics or for the effect you want to obtain.

Button 5 (GLOBAL 3)

These parameters relate to the SYNC IN/SYNC OUT jack settings.

Sync In Unit [16th Note, 8th Note]

The Sync In Units determine how much the Sequencer will advance with each pulse received via the SYNC IN jack.

16th Note: The Sequencer will advance one sixteenth note for each pulse.

8th Note: The Sequencer will advance one eighth note for each pulse.

TIP When Step Resolution in the SEQ EDIT mode is set to 1/16, a sixteenth note will be equal to one step, and an eighth note will be equal to two steps.

Sync Out Unit [16th Note, 8th Note]

The Sync Out Units determine how far the Sequencer needs to advance in order to generate a pulse via the SYNC OUT jack.

16th Note: A pulse will be outputted for every sixteenth note.

8th Note: A pulse will be outputted for every eighth note.

TIP When Step Resolution in the SEQ EDIT mode is set to 1/16, a sixteenth note will be equal to one step, and an eighth note will be equal to two steps.

Sync In Polarity [Rise, Fall]

In order to achieve synchronization with other units, the polarity of the SYNC IN jack may need to be changed.

Rise: The monologue will sync to the pulse as it rises to its crest (the highest point) of the waveform.

Fall: The monologue will sync to the pulse as it falls to its trough (the lowest point) of the waveform.

Sync Out Polarity [Rise, Fall]

In order for other units to correctly sync with the monologue, the polarity of the SYNC OUT jack may need to be changed.

Rise: The monologue will create a sync pulse as it rises to its crest (the highest point) of the waveform.

Fall: The monologue will create a sync pulse as it falls to its trough (the lowest point) of the waveform.

Button 6 (GLOBAL 4)

These parameters relate to the monologue's MIDI capabilities.

MIDI Ch [1...16]

In order to communicate, the monologue and your other MIDI devices must be set to the same MIDI channel. This is both the Transmit and Receive channel.

Clock Source [Auto (USB), Auto (MIDI), Internal]

Many features of the monologue can be sync'd to the tempo or BPM. This parameter allows you to specify whether the clock source is internal, or an external MIDI Clock Source.

Auto (USB), Auto (MIDI): When there is no input, the internal clock will be used; and when input is detected, the internal clock will be synchronized to the clocks from the USB B and MIDI IN connectors respectively.

Internal: Only the internal clock to be used.

- ▲ When a cable is plugged into the SYNC IN jack, the internal clock is synchronized to the SYNC IN jack clock, regardless of the MIDI clock settings.

Enable Rx MIDI [Off, On]

Sets whether MIDI channel messages can be received or not.

En Rx Transport [Off, On]

Sets whether Transport-related MIDI system real-time messages (start, stop, continue) can be received or not.

Enable Tx MIDI [Off, On]

Sets whether MIDI channel messages can be transmitted or not.

MIDI Route [USB+MIDI, USB]

MIDI signals can be sent and received via the MIDI and USB connectors, or by the USB connector alone.

USB+MIDI: MIDI messages are received via the USB B connector and the MIDI IN connector; messages are transmitted from the USB B connector and the MIDI OUT connector.

USB: MIDI messages will be transmitted and received only via the USB B connector. When using the USB connector as a MIDI interface, it is advantageous to use this setting.

Button 7 (GLOBAL 5)

These parameters relate to the monologue's display, and what information is seen there.

Parameter Disp [Normal, All]

Normal: Only major information such as operating the pitch-related knobs or switching the MOTION/SLIDE/NOTE switch will be displayed.

All: When any knob except for the MASTER knob is turned, the value is indicated; and when operating a switch, the setting is indicated.

- ⚠ When the MOTION/SLIDE/NOTE switch is set to "MOTION", the values and settings will not be displayed.

Button 8 (GLOBAL 6)

Configures the type of batteries to be used on the monologue, as well as the display and power settings.

Battery Type [Alkaline, Ni-MH]

In order to accurately detect the remaining battery power, select the type of battery being used.

Alkaline: Use this setting for alkaline batteries.

Ni-MH: Use this setting for nickel-metal hydride batteries.

- ⚠ The remaining battery level will not be indicated correctly while an AC adapter (sold separately) is connected.

Auto Power Off [Off, On]

Using the **Auto Power Off feature**, the monologue can be set to automatically turn off after approximately four hours have elapsed without any operation of the knobs, switches, or keyboard, and without any input. Once this occurs, you will need to turn the monologue on again manually.

Off: The Auto Power Off feature will be disabled.

On: The Auto Power Off feature is enabled. For details, refer to "Auto Power Off Feature" (p. 8)

Brightness [1...10]

Adjusts the display brightness.

- ⚠ Continuous use of the monologue while the brightness is set to a high value will have an adverse effect on the overall life of the display.

Button 10 (USER SCALE)

USER SCALE 1..6

This allows you to set up to six original user scales. The pitches of all of the notes can be changed to create scales with irregular pitches.

Pitches can be set in cents by turning the PROGRAM/VALUE knob. Turning the PROGRAM/VALUE knob while holding the SHIFT button will change the tuning in semitones (100 cents). For details, refer to "Microtuning function" (p. 46).

- ▲ SysEx data for microtuning can be received while this parameter is being displayed. This overwrites the scale currently being edited, regardless of what number is specified in the message.

Button 11 (USER OCTAVE)

USER OCTAVE 1..6

This allows you to set up to six original octave scales. When one of the pitches is changed within the octave, that setting will be reflected throughout the entire tonal range.

Pitches can be set in cents by turning the PROGRAM/VALUE knob. Turning the PROGRAM/VALUE knob while holding the SHIFT button will change the tuning in semitones (100 cents). For details, refer to "Microtuning function" (p. 46).

- ▲ SysEx data for microtuning can be received while this parameter is being displayed. This overwrites the scale currently being edited, regardless of what number is specified in the message.

Button 12 (SCALE CLEAR)

USER SCALE 1..6

This initializes the microtuning that was edited using USER SCALE 1–6, button 10. Press button 12 to select the microtuning to initialize. Turn the PROGRAM/VALUE knob until "Press WRITE" is indicated on the display, and then press the WRITE button.

USER OCTAVE 1..6

This initializes the microtuning that was edited using USER OCTAVE 1–6, button 11.

Press button 12 to select the microtuning to initialize. Turn the PROGRAM/VALUE knob until "Press WRITE" is indicated on the display, and then press the WRITE button.

Button 13 (SCALE DUMP)

USER SCALE 1..6

This transmits the microtuning that was edited using USER SCALE 1–6 as a general SysEx message.

Press button 13 to select the microtuning to transmit via SysEx. Turn the PROGRAM/VALUE knob until "Press WRITE" is indicated on the display, and then press the WRITE button.

USER OCTAVE 1..6

This transmits the microtuning that was edited using USER OCTAVE 1–6 as a general SysEx message.

Press button 13 to select the microtuning to transmit via SysEx. Turn the PROGRAM/VALUE knob until "Press WRITE" is indicated on the display, and then press the WRITE button.

Button 15 (ALL DUMP)

These parameters allow you to perform a dump of all the internal data, either via MIDI or via USB.

All Dump (USB)

Turn the PROGRAM/VALUE knob until "Press WRITE" is indicated in the display. The WRITE button will blink.

Press the WRITE button to transmit the MIDI data dump via the USB B connector. The display will indicate the message "Transmitting". The data will take about 10 seconds to transmit.

- ⚠ If the USB cable is not connected, or if the MIDI IN port on the PC is not open, the data will not be transmitted.

All Dump (MIDI)

Turn the PROGRAM/VALUE knob until "Press WRITE" is indicated in the display. The WRITE button will blink.

Press the WRITE button to transmit the MIDI data dump via the MIDI OUT connector. The display will indicate the message "Transmitting". The data will take about 30 seconds to transmit.

Other functions

Tuning

As with all analog instruments, the monologue's circuitry can drift over time during performance due to changes in environment and temperature. The monologue provides an **auto-tuning function** that automatically tunes the instrument's analog circuits on demand, to correct for any analog drift.

As you continue to play the monologue for a while right after you've turned it on, the pitch and tone may gradually drift. If the pitch drift becomes noticeable, use the steps below to tune the instrument. This will manually bring the monologue back into tune.

1. Press the REC button while holding down the SHIFT button.

Tuning will begin, and the display will indicate "Tuning...".

The tuning will take about 15 seconds.

⚠ During tuning, you will temporarily be unable to play the monologue.

Microtuning function

Microtuning is a method of changing the equal temperament tuning scale normally used on the keyboard to a different tuning.

The monologue includes different preset microtunings, and allows you to create your own microtunings.

There are 12 microtunings available for editing. Six of these tunings are "user scales", where the pitch of any note on the keyboard can be changed; and the remaining six tunings are "user octaves", where the tunings of each key in a single octave can be changed, which will then repeat across the keyboard.

A different microtuning can be selected for each program on the monologue. For details, refer to "Microtuning" (p. 32), PROGRAM EDIT mode.

Editing the microtuning

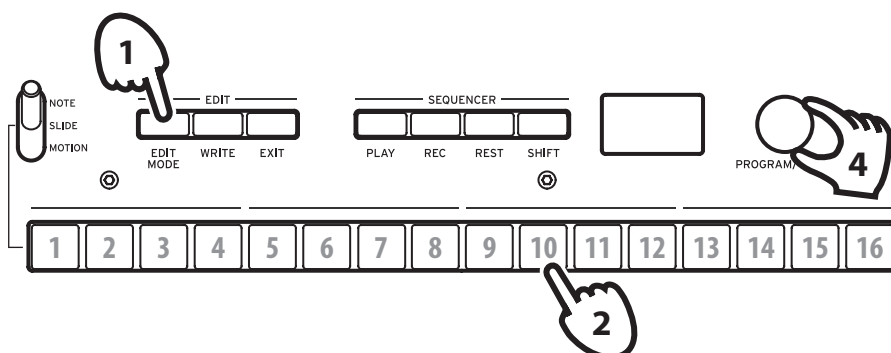

Let's now edit USER SCALE 3.

1. Enter GLOBAL EDIT mode by pressing the EDIT MODE button.

2. Press button 10 three times.

USER SCALE 3 will be indicated on the display.



3. Play the note you wish to edit on the keyboard.

The note name will be indicated on the display.



When this screen is displayed, the microtuning currently being edited will be used when playing sound.

TIP Up to four notes can be edited at the same time, by pressing up to four keys together on the keyboard.

4. Turn the PROGRAM/VALUE knob to set how many cents the note played will deviate from equal temperament tuning.



Turning the PROGRAM/VALUE knob while holding the SHIFT button will shift the note name played to an entirely different note.



When editing the USER OCTAVE, press button 11 to display the USER OCTAVE screen as shown in step 2 above, and then follow steps 3 and onwards.

Restoring the Factory settings

You can restore the monologue's preset Programs and global settings to their original factory-set state at any time.

1. Begin with the monologue turned Off.

2. While holding down the WRITE button and the EXIT button, turn the monologue On.

"FACTORY RESET" will be indicated in the display.

3. Turn the PROGRAM/VALUE knob to select the items you wish to reset to the factory default settings.

PRESET: Restores the preset Programs (Programs 1–80) to their factory-set default settings.

⚠ This will replace the existing preset Programs with the factory-set default Programs. If you want to keep the existing preset Programs beforehand, press the WRITE button to save the presets to the user Programs (Programs 81–100).

GLOBAL: Restores the GLOBAL settings to their factory default settings. This also includes any favorite Programs that you have registered.

ALL: Restores the preset Programs (Programs 1–80), Programs 81–100, and GLOBAL settings to their factory-set default settings.

⚠ Use caution, as this will replace all data with the factory-set default settings (which will erase your user Programs).

4. Press the WRITE button.

The display will indicate the message "Are you sure?".

5. Turn the PROGRAM/VALUE knob to select "Yes", and press the WRITE button.

The factory-set default data will be reloaded, and the monologue will be restored to its factory default state.

TIP Press the EXIT button, or select "No" using the PROGRAM/VALUE knob and press the WRITE button to cancel the operation.

⚠ Never turn off the monologue while data is being loaded.

Shortcuts using the SHIFT button

By holding down the SHIFT button as you press other select buttons, you can access a number of convenient features quickly and easily.

Function	SHIFT button +	
Load panel information	When in Play mode: PLAY button	Loads the state of the front panel switches and knobs into the selected Program. Used to make the sound match the state of the controls on the front panel.
Tuning	When in Play mode: REC button	When the monologue's sound generator is not making any sound, auto-tuning occurs automatically; but you can use this function to re-tune the monologue manually in Play mode if the tuning seems to be drifting. The internal temperature tends to change more right after the power is turned on, which may cause the instrument to go out of tune. Press the REC button while holding down the SHIFT button again to cancel manual tuning, if you accidentally started it by mistake.
Delete sequence data	When in Play mode: REST button	Deletes all sequence data for the selected Program (including notes and Motion Sequence settings). Press the REC button while holding down the SHIFT button again before doing anything else to cancel deleting the sequence data, if you accidentally started this operation by mistake.
Select a Program	When in Play mode: PROGRAM/VALUE knob	Skips the selected Program forward or backwards, in increments of 10.
INT settings for the EG and LFO	When in Play mode: EG INT knob LFO INT knob	The value can be changed in the negative range.
Editing the Micro-tuning	When editing the USER SCALE or USER OCTAVE in GLOBAL EDIT mode: PROGRAM/VALUE knob	The pitch can be changed in 100 cent (semitone) intervals.
VCO 2 PITCH settings	When in Play mode: VCO 2 PITCH knob	The pitch can be changed in 100 cent (semitone) intervals.

Understanding MIDI

MIDI stands for Musical Instrument Digital Interface, and is a worldwide standard for exchanging various types of musical data between electronic musical instruments and computers.

When MIDI cables are used to connect two or more MIDI devices, performance data can be exchanged between the devices, even if they were made by different manufacturers.

MIDI data can also be exchanged between the monologue and your personal computer using a single USB cable. The monologue lets you assign MIDI control change numbers (CC#) to the major parameters that affect the sound, and control these parameters from an external MIDI sequencer while you play the tone generator. You can also use the front panel knobs or buttons to transmit these control change messages, in order to control an external MIDI device. You can also synchronize the monologue's tempo to the MIDI clock of an external MIDI sequencer or other device, so that the monologue will play in time with the external device and with any changes you make.

Connecting Devices via MIDI and USB

Controlling an external MIDI device from the monologue

If you want to use the monologue's keyboard, controllers, and sequencer to play sounds on or to control an external MIDI tone generator, connect the monologue's MIDI OUT connector to the external MIDI tone generator's MIDI IN connector using a MIDI cable.

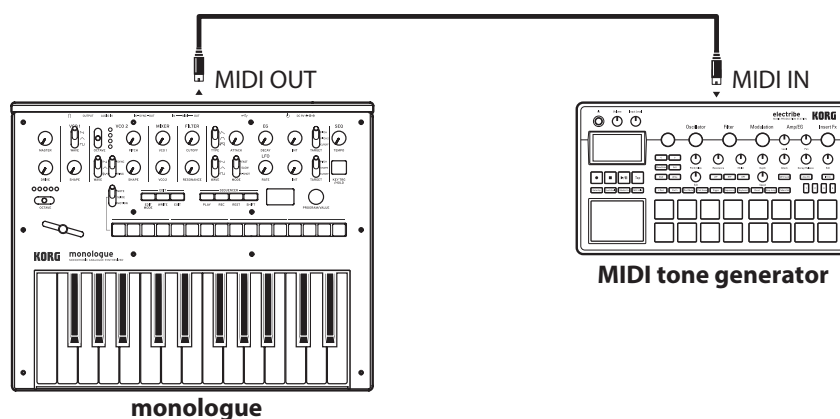

Controlling the monologue from an external MIDI device

If you want to play or control the monologue from another MIDI keyboard, sequencer, or other device, connect the MIDI OUT connector of the external MIDI device to the monologue's MIDI IN connector with a MIDI cable.

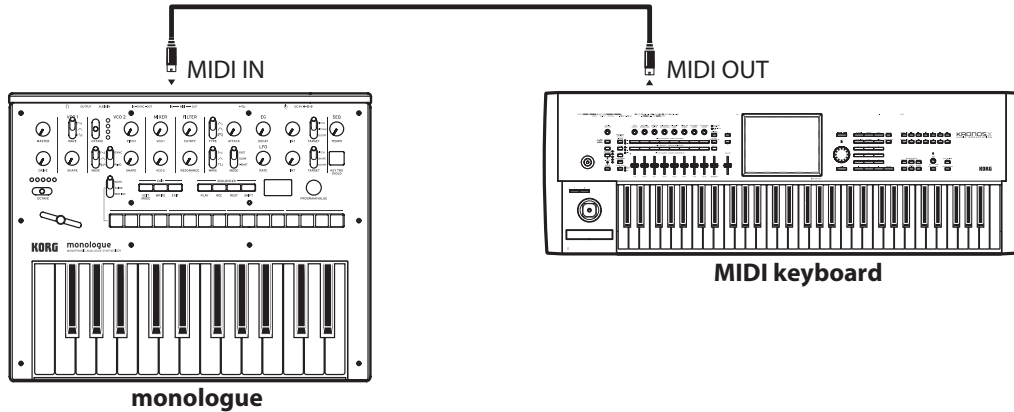

Connecting the monologue to a computer via MIDI

You might want to play the monologue's keyboard and record your performance on an external MIDI sequencer or computer (connected using the MIDI interface), and then play the monologue while monitoring or playing back what you recorded. You also might want to use the monologue as both an input device for playing notes and as a MIDI tone generator. In either case, you'll need to connect the MIDI OUT connector to the MIDI IN connector on both the monologue and the external MIDI sequencer or computer.

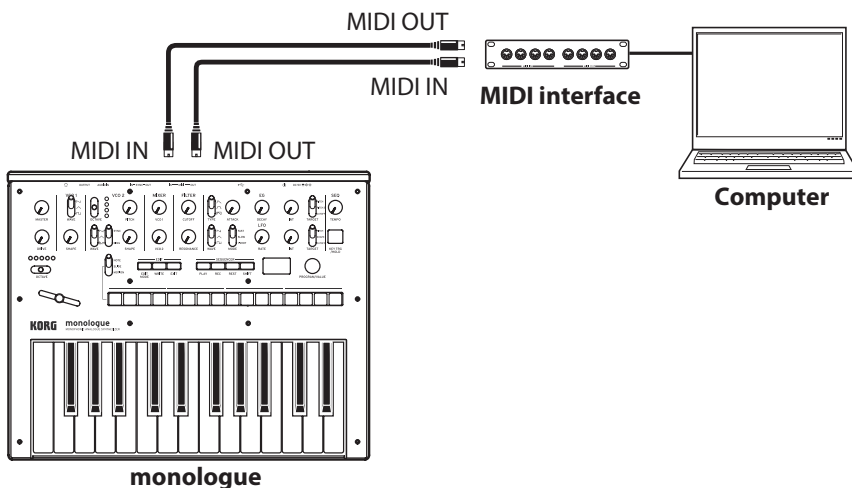

 Some MIDI interface devices may be unable to transmit or receive MIDI SysEx messages to or from the monologue.

TIP It's convenient to use the USB connector when connecting the monologue to a personal computer.

Connecting the monologue to a computer via USB

In order to use a USB connection, you'll need to install the Korg USB-MIDI driver on your computer. Download the "Korg USB-MIDI driver" from the Korg website, and install it as described in the accompanying documentation.

- ▲ If either the MIDI connection or the USB connection is not working properly, check the settings in button 6 (MIDI Route) of the GLOBAL EDIT mode ("MIDI Route", p. 42).

MIDI-Related Settings

Setting the MIDI channel

In order to exchange data with a connected external MIDI device, you must set the monologue's MIDI channel to match the MIDI channel of the external MIDI device.

Use the button 6 (MIDI Ch) in the GLOBAL EDIT mode to set the monologue's MIDI channel ("MIDI Ch", p. 42).

- TIP** When synchronizing to an external MIDI device, refer to that device's Owner's manual.

Configuring the MIDI "LOCAL" setting when connected to an external MIDI sequencer or computer

The Echo Back setting of your external MIDI sequencer or computer system allows the MIDI notes and other messages being played by the monologue to be instantly passed along to any other MIDI equipment, including synthesizers, tone generators. However, this same Echo Back function can cause the monologue to double trigger: once when you play the note, and a second time as the external MIDI sequencer or computer system sends the note back to the monologue. To prevent this from happening, you can simply disable the LOCAL connection between the monologue keyboard and the tone generating circuitry. The LOCAL feature is accessed using button 4 (Local SW) in the GLOBAL EDIT mode ("Local SW", p. 39).

Configuring the monologue to transmit and receive MIDI channel messages

The monologue can be configured to enable or disable the receiving or transmission of MIDI channel messages.

To receive or transmit MIDI channel messages, turn the “Enable Rx MIDI” and “Enable Tx MIDI” settings on using button 6 in the GLOBAL EDIT mode (“Enable Rx MIDI”, p. 42) (“Enable Tx MIDI”, p. 42).

Synchronizing the Sequencer

Use the “Clock Source” setting on button 6 in the GLOBAL EDIT mode to set whether the monologue will be the master (the device controlling the synchronization) or the slave (the device being controlled) when the Sequencer is played (“Clock Source”, p. 42).

TIP When synchronizing to an external MIDI device, refer to that device’s Owner’s manual.

Using the monologue as the master to slave external MIDI devices

Connect the MIDI OUT connector of the monologue to the MIDI IN connector on your external MIDI device(s).

In the GLOBAL EDIT mode, set the Clock Source of the monologue to “Internal”, and configure the external MIDI device to receive clock data via MIDI. The monologue will act as the master, and the tempo that is set using the TEMPO knob on the monologue will be sent as MIDI timing clock data to operate the external MIDI device (sequencers, rhythm machines, and so on).

Slaving the monologue clock to an external MIDI device

Connect the MIDI IN connector of the monologue to the MIDI OUT connector on your external MIDI device.

In the GLOBAL EDIT mode, set the Clock Source of the monologue to “Auto (MIDI)”, and configure the external MIDI device to transmit MIDI clock data. The monologue will automatically act as the slave whenever a MIDI timing clock is received, and will be driven by the tempo of the external MIDI device (sequencers, rhythm machines, and so on).

TIP Even if you set the Clock Source to “Auto (USB)” or “Auto (MIDI)”, the monologue will operate in “Internal” MIDI clock mode, unless a clock is received from an external device.

Program List

No.	Program Name	Category	Slider Assign	Author
1	<afx acid3>	Bass	PITCH BEND	Aphex Twin
2	Injection	Bass	PITCH BEND	KORG Inc.
3	Anfem	Hit	CUTOFF	Sharooz
4	<wavetable>	Bass	GATE TIME	Aphex Twin
5	Lu-Fuki	Bass	PITCH BEND	Yebisu303
6	Fake3OSC	Hit	PITCH BEND	Yebisu303
7	Arc Lead	Lead	PITCH BEND	KORG Inc.
8	<Flute>	Arp	PITCH BEND	Aphex Twin
9	Scooping	SFX	PITCH BEND	Yebisu303
10	Robot Empire	Drum	DECAY	Yebisu303
11	TeeVeeSaw	Bass	PITCH BEND	Yebisu303
12	<AFX> bAss	Bass	PITCH BEND	Aphex Twin
13	<model 800>	Bass	PITCH BEND	Aphex Twin
14	<epic acid>	Bass	PITCH BEND	Aphex Twin
15	Herd Of Crab	Bass	PITCH BEND	Yebisu303
16	Stonecold	Bass	CUTOFF	Sharooz
17	Dirty Sub	Bass	PITCH BEND	Yebisu303
18	Jungle Sub	Bass	LFO INT	Yebisu303
19	<deep bass>	Bass	CUTOFF	Aphex Twin
20	Hoodie Bass	Bass	PITCH BEND	KORG Inc.
21	StabbyBass	Bass	PITCH BEND	KORG Inc.
22	DistortedSqr	Bass	EG INT	Yebisu303
23	Werg	Bass	EG INT	Sharooz
24	<Ratewobble	Bass	LFO RATE	Aphex Twin
25	StomachWave	Bass	CUTOFF	KORG Inc.
26	Dr.Juice	Bass	PITCH BEND	KORG Inc.
27	Rubber Duck	Bass	PITCH BEND	Yebisu303
28	<HarmonBa>	Bass	LFO INT	Aphex Twin
29	Dark Perc	Bass	PITCH BEND	KORG Inc.
30	Jackathon	Bass	CUTOFF	Sharooz
31	Bosshog	Bass	VCO1 PITCH	Sharooz
32	<Ardkore92>	Bass	PITCH BEND	Aphex Twin
33	<aliasBass>	Bass	PITCH BEND	Aphex Twin
34	<PWM envBA>	Bass	PITCH BEND	Aphex Twin
35	Disemvowel	Bass	EG INT	Sharooz
36	Kickin'B	Bass	CUTOFF	KORG Inc.
37	OIOI	Bass	PITCH BEND	Yebisu303
38	<akunk b>	Bass	PITCH BEND	Aphex Twin
39	Dual Saw	Lead	PITCH BEND	KORG Inc.
40	BitterLead	Lead	PITCH BEND	KORG Inc.

No.	Program Name	Category	Slider Assign	Author
41	Syncwave	Lead	LFO INT	Sharooz
42	<Duophony>	Lead	PITCH BEND	Aphex Twin
43	Mono Brass	Lead	PITCH BEND	KORG Inc.
44	<5th brASs>	Lead	PITCH BEND	Aphex Twin
45	Bouncy Balls	Lead	PITCH BEND	Yebisu303
46	Ghost Town	Lead	PITCH BEND	Yebisu303
47	Childhood	Lead	RESONANCE	KORG Inc.
48	On the Moon	Lead	PITCH BEND	KORG Inc.
49	<phaseClks>	Lead	PITCH BEND	Aphex Twin
50	<SyncMtion>	Lead	VCO1 PITCH	Aphex Twin
51	<SyncLAM>	Lead	PITCH BEND	Aphex Twin
52	Arpme Lead	Arp	PITCH BEND	KORG Inc.
53	Squelf	Arp	VCO1 PITCH	Sharooz
54	Milky Way	Arp	PITCH BEND	Yebisu303
55	BrokenArcade	Arp	PITCH BEND	Yebisu303
56	<MT-digArp>	Arp	PITCH BEND	Aphex Twin
57	Chopchoon	Arp	LFO INT	Sharooz
58	FMod Seq	Arp	PITCH BEND	KORG Inc.
59	Tronlines	Arp	EG INT	Sharooz
60	Tech Stab	Hit	PITCH BEND	Yebisu303
61	Pumpdriver	Hit	LFO RATE	KORG Inc.
62	Lfoiled	Hit	VCO2 PITCH	Sharooz
63	< Digsnd >	Hit	PITCH BEND	Aphex Twin
64	<ascension>	SFX	LFO RATE	Aphex Twin
65	<centipede>	SFX	PITCH BEND	Aphex Twin
66	Robotspeak	SFX	VCO1 PITCH	Sharooz
67	Cpu Cycles	SFX	LFO INT	Sharooz
68	Loud Siren	SFX	PITCH BEND	Yebisu303
69	Portrythm	SFX	PITCH BEND	KORG Inc.
70	Dambuster	SFX	CUTOFF	Sharooz
71	<xoc PLAY>	SFX	LFO RATE	Aphex Twin
72	LittleGlitch	SFX	LFO RATE	Yebisu303
73	Hard Run	Drum	ATTACK	Yebisu303
74	<beat&bass>	Drum	GATE TIME	Aphex Twin
75	<bnsbeats1>	Drum	GATE TIME	Aphex Twin
76	<bnsbeats2>	Drum	DECAY	Aphex Twin
77	<bnsbeats3>	Drum	DECAY	Aphex Twin
78	<bnsbeats4>	Drum	GATE TIME	Aphex Twin
79	<bnsbeats5>	Drum	GATE TIME	Aphex Twin
80	<afx beat>	Drum	GATE TIME	Aphex Twin
81				
:				
100	Init Program			

All Programs were made by Aphex Twin, Sharooz, Yebisu303 and KORG Inc.

For more information about the authors please visit:

- Sharooz

<http://www.soundcloud.com/sharooz>



- Yebisu303

<https://www.youtube.com/user/yebisu303/>

<https://soundcloud.com/yebisu303>

Specifications

Keyboard:	25 keys (slim keyboard, velocity sensitive)
Sound Generation:	Analog synthesis
Number of programs:	100 (80 preset programs, 20 user programs) Each program includes microtuning and sequence data settings
Main synthesis parameters	
MASTER:	DRIVE
VCO 1:	WAVE (SAW, TRIANGLE, SQUARE), SHAPE
VCO 2:	OCTAVE, WAVE (SAW, TRIANGLE, NOISE), SYNC/RING, PITCH, SHAPE
MIXER:	VCO1, VCO2
FILTER:	CUTOFF, RESONANCE
EG:	TYPE (A/D, A/G/D, GATE) ATTACK, DECAY, INT, TARGET (PITCH, PITCH 2, CUTOFF)
LFO:	WAVE (SAW, TRIANGLE, SQUARE), MODE (FAST, SLOW, 1-SHOT), RATE, INT, TARGET (PITCH, SHAPE, CUTOFF)
Sequencer:	16-step monophonic sequencer Motion sequence can be used on up to four parameters
Microtuning:	32 settings (20 Preset tunings / 6 User scales / 6 User octaves) Each setting can be set the key.
Controls:	23 dedicated panel controls deliver immediate parameter access A slider can control different parameters for each program
Display:	Real-time OLED oscilloscope provides visual feedback of parameter changes
Connectors:	Headphones jack (ø6.3mm stereo phone jack) OUTPUT jack (ø6.3mm monaural phone jack) AUDIO IN jack (ø6.3mm monaural phone jack) SYNC IN jack (ø3.5mm stereo mini-phone jack, 20V maximum input level) SYNC OUT jack (ø3.5mm stereo mini-phone jack, 5V output level) MIDI IN connector MIDI OUT connector USB Type B connector

Power supply:	AA alkaline battery x 6 or AA nickel-metal hydride battery x 6 Or AC adapter (DC 9V ) (optional)
Battery life:	Approximately 6 hours (using alkaline batteries) Approximately 8 hours (using nickel-metal hydride batteries) Battery life will vary depending on the batteries used and on the conditions of use.
Power consumption:	2.5 W
Dimensions (W x D x H):	350 x 276 x 76 mm 13.78 x 10.87 x 2.99 inches
Weight:	1.7 kg/3.78 lbs. (excluding batteries)
Operating temperature:	0–+40 °C (non-condensing)
Included items:	AA alkaline battery x 6, Quick Start Guide, Precautions
Options:	AC adapter (DC 9V ) , Sync cable

* Specifications and appearance are subject to change without notice for improvement

* All product names and company names are the trademarks or registered trademarks of their respective owners.

* Since the rear panel of this instrument uses natural wood, there will be individual differences in the wood grain, surface texture and color.

MIDI Implementation Chart

Function...		Transmitted	Received	Remarks
Basic Channel	Default Change	1-16 1-16	1-16 1-16	Memorized
Mode	Default Messages Altered	X X *****	3 X	
Note Number	True Voice	0-127 *****	0-127 0-127	*1
Velocity	Note On Note Off	O 9n, V=1-127 X 8n, V=64	O 9n, V=1-127 X	
After Touch	Key's Channel	X X	X X	
Pitch Bend		O	O	
Control Change	16, 17, 25	O	O	EG (ATTACK, DECAY, INT) *1
	24, 26	O	O	LFO (RATE, DEPTH) *1
	28	O	O	DRIVE *1
	35	O	O	PITCH (VCO 2) *1
	36, 37	O	O	SHAPE (VCO 1, 2) *1
	39, 40	O	O	LEVEL (VCO 1, 2) *1
	43	O	O	CUTOFF *1
	44	O	O	RESONANCE *1
	49	O	O	OCTAVE (VCO 2) *1
	50, 51	O	O	WAVE (VCO 1, 2) *1
56, 58, 59	O	O	LFO (TARGET, WAVE, MODE) *1	
60	O	O	SYNC/RING *1	
61, 62	O	O	EG (TYPE, TARGET) *1	
Program Change	True Number	O 0-99 *****	O 0-99 0-99	*1
System Exclusive		O	O	
System Common	Song Position Song Select Tune Request	X X X	X X X	
System Real Time	Clock Commands	O O	O O	*2
Aux Meassages	Local On/Off	X	O	*3
	All Notes Off	X	O 123-127	*3
	Active Sense	O	O	
	System Reset	X	X	
Notes *1: When the Global setting is "Enable Tx MIDI=On", the minilogue will transmit signals; and when the Global setting is "Enable RX MIDI=ON", the minilogue will receive signals. *2: When the Global setting is "Clock Source=Internal", the minilogue will not receive signals. The minilogue will receive signals when set to "Auto(MIDI)" or "Auto(USB)". *3: When the Global setting is "Enable RX MIDI=ON", the minilogue will receive signals.				

Mode 1: Omni On, Poly
 Mode 3: Omni Off, Poly

Mode 2: Omni On, Mono
 Mode 4: Omni Off, Mono

O: Yes
 X: No

Consult your local Korg distributor for more information on MIDI implementation.

KORG INC.

4015-2 Yanokuchi, Inagi-City, Tokyo 206-0812 JAPAN

© 2016 KORG INC. www.korg.com

Published 11/2016