

Headphones 1U

Stereo Headphone Amplifier



Manual Revision: 2019.08.07

Table of Contents

[Compliance](#)

[Installation](#)

[Before Your Start](#)

[Installing Your Module](#)

[Front Panel](#)

[Version 1 vs Version 2](#)

[Using The 3-Pin Link Connector \(version 2 only\)](#)

[Technical Specifications](#)

[Version 2](#)

[Version 1](#)

Compliance



This device complies with Part 15 of the FCC Rules. Operation is subject to the following two conditions: (1) this device may not cause harmful interference, and (2) this device must accept any interference received, including interference that may cause undesired operation.

Changes or modifications not expressly approved by Intellijel Designs, Inc. could void the user's authority to operate the equipment.

Any digital equipment has been tested and found to comply with the limits for a Class A digital device, pursuant to part 15 of the FCC Rules. These limits are designed to provide reasonable protection against harmful interference when the equipment is operated in a commercial environment. This equipment generates, uses, and can radiate radio frequency energy and, if not installed and used in accordance with the instruction manual, may cause harmful interference to radio communications.



This device meets the requirements of the following standards and directives:

EMC: 2014/30/EU

EN55032:2015 ; EN55103-2:2009 (EN55024) ; EN61000-3-2 ; EN61000-3-3

Low Voltage: 2014/35/EU

EN 60065:2002+A1:2006+A11:2008+A2:2010+A12:2011

RoHS2: 2011/65/EU

WEEE: 2012/19/EU

Installation

This module is designed for use within an Intellijel-standard 1U row, such as contained within the Intellijel 4U and 7U Eurorack cases. Intellijel's 1U specification is derived from the Eurorack mechanical specification set by Doepfer that is designed to support the use of lipped rails within industry standard rack heights.

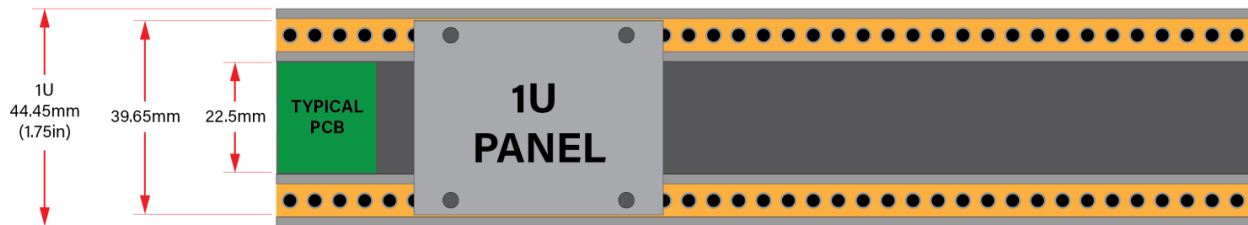
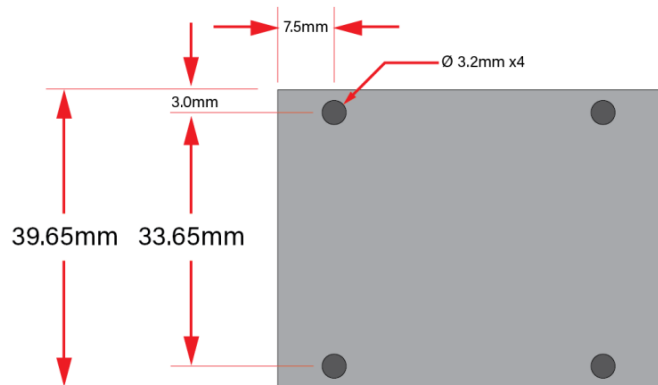

Before Your Start

Intellijel Eurorack modules are designed to be used with a Eurorack-compatible case and power supply. We recommend you use Intellijel cases and power supplies.

Before installing a new module in your case, you must ensure your power supply has a free power header and sufficient available capacity to power the module:

- Sum up the specified +12V current draw for all modules, including the new one. Do the same for the -12 V and +5V current draw. The current draw will be specified in the manufacturer's technical specifications for each module.
- Compare each of the sums to specifications for your case's power supply.
- Only proceed with installation if none of the values exceeds the power supply's specifications. Otherwise you must remove modules to free up capacity or upgrade your power supply.

You will also need to ensure your case has enough free space (hp) to fit the new module. To prevent screws or other debris from falling into the case and shorting any electrical contacts, not leave gaps between adjacent modules, and cover all unused areas with blank panels. Similarly, do not use open frames or any other enclosure that exposes the backside of any module or the power distribution board.

You can use a tool like [ModularGrid](#) to assist in your planning. Failure to adequately power your modules may result in damage to your modules or power supply. If you are unsure, please [contact us](#) before proceeding.

Installing Your Module

When installing or removing a module from your case always turn off the power to the case and disconnect the power cable. Failure to do so may result in serious injury or equipment damage.

Ensure the 10-pin connector on the power cable is connected correctly to the module before proceeding. The red stripe on the cable must line up with the -12V pins on the module's power connector. Different modules use different ways to indicate the -12V pins. Some may be labelled with "-12V;" a white stripe next to the -12V pins; the words "red stripe;" or some combination of these. Additionally, some modules may have shrouded headers, thus preventing backward connections.

Most modules will come with the cable already connected but it is good to double check the orientation. Be aware that some modules may have headers that serve other purposes so ensure the power cable is connected to the right one.

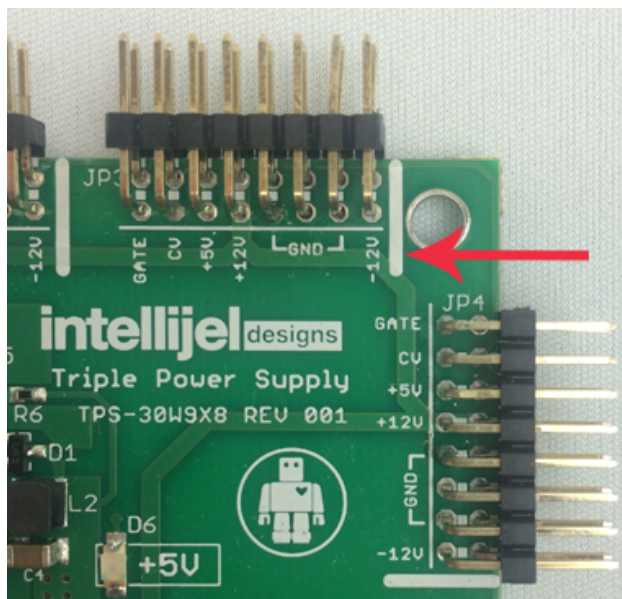
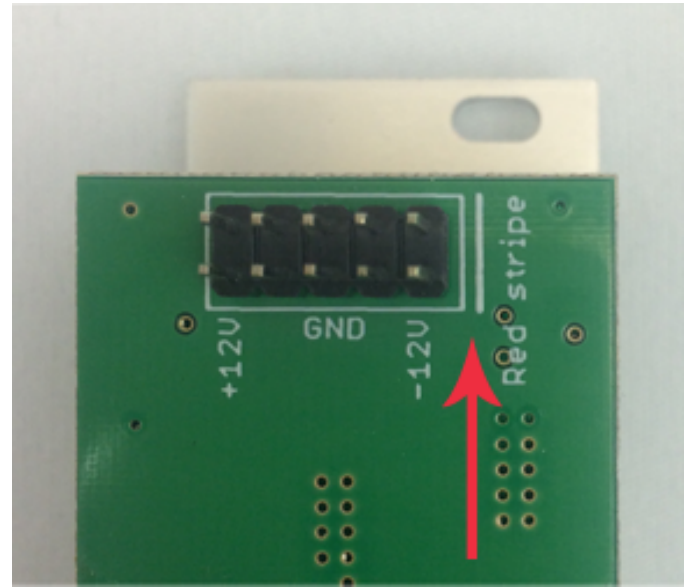

The other end of the cable, with a 16-pin connector, connects to the power bus board of your Eurorack case. Ensure the red stripe on the cable lines up with the -12V pins on the bus board. On Intellijel power supplies the pins are labelled with the label "-12V" and a thick white stripe:

If you are using another manufacturer's power supply, check their documentation for instructions.

Once connected, the cabling between the module and power supply should resemble the picture below:

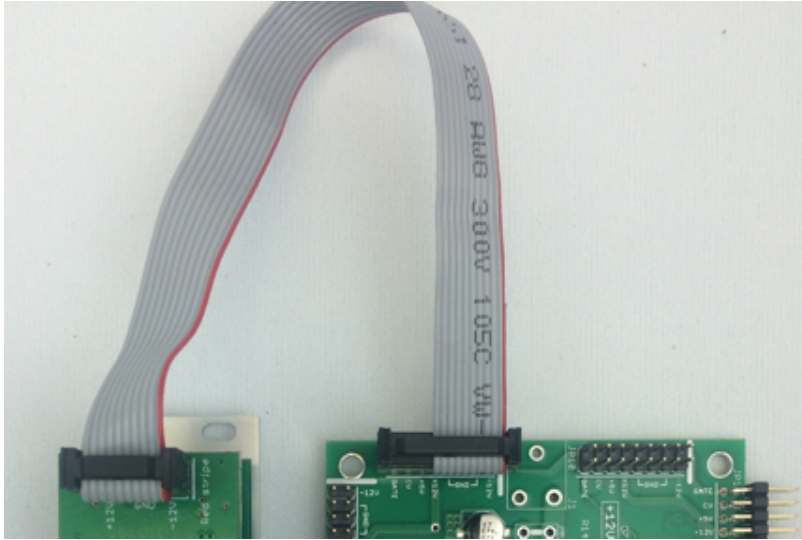

Before reconnecting power and turning on your modular system, double check that the ribbon cable is fully seated on both ends and that all the pins are correctly aligned. If the pins are misaligned in any direction or the ribbon is backwards you can cause damage to your module, power supply, or other modules.

After you have confirmed all the connections, you can reconnect the power cable and turn on your modular system. You should immediately check that all your modules have powered on and are functioning correctly. If you notice any anomalies, turn your system off right away and check your cabling again for mistakes.

After you have confirmed all the connections, you can reconnect the power cable and turn on

Front Panel

1. L Input

Eurorack-level audio sent into this jack is scaled by the **HEADPHONE Level Knob [4]** and sent to the stereo **HEADPHONE Out jack [3]**.

2. R Input

Eurorack-level audio sent into this jack is scaled by the **HEADPHONE Level Knob [4]** and sent to the stereo **HEADPHONE Out jack [3]**.

*NOTE 1: The **L Input** jack is normalled to the **R Input***

*jack. If nothing is connected to the **R Input** jack, then a mono signal fed into the **L Input** jack will feed both channels in the headphones.*

NOTE 2: If you have version 2 of the Headphones 1U module and are using its rear-panel 3-pin Link connector to monitor audio from another module, please see [“Using The 3-Pin Link Connector”](#) to learn more.

3. HEADPHONE Output

This is a stereo 1/4" output intended primarily for headphones. Its volume level is set with the **HEADPHONE Level knob [4]**.

4. HEADPHONE Level Knob

Controls the level of the headphone output.

CAUTION: Always be mindful of volume levels when listening through headphones. Keep this level as low as required. Your future self will thank you.



Version 1 vs Version 2

There are two versions of the Headphones 1U module. Version 2, which replaced Version 1 in August 2019, features the addition of a 3-pin Link connection on its rear panel, as seen below.

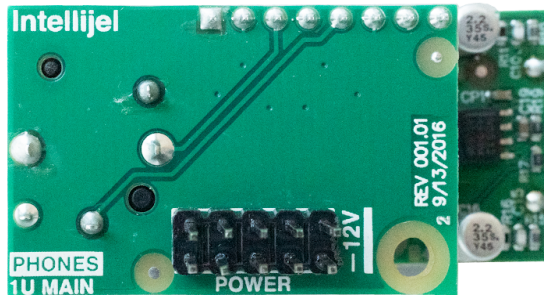

VERSION 1 variations have only a single power connector on the rear panel

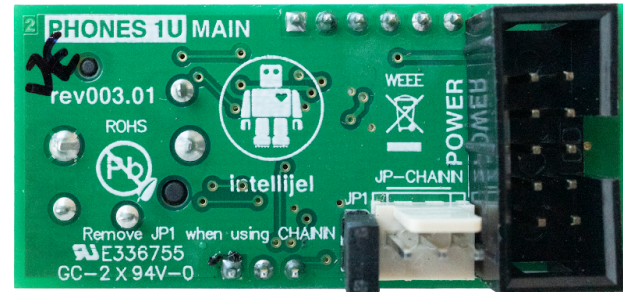

VERSION 2 has power, plus a 3-pin Link Connector (and normaling jumper) on the rear panel

Using The 3-Pin Link Connector (version 2 only)

Version 2 of the Headphones 1U Module features a 3-pin Link connector on the rear panel. This is an *input* connector, which allows you to send audio directly into the Headphones 1U module by connecting it to the 3-pin Link *output* connector of another module.

Using this connector, you can send audio from either a *Stereo Line Out 1U* or *Mixup* directly into the Headphones 1U, without using the front panel jacks. This is particularly convenient for setting up a headphone feed that duplicates the audio being sent to the main output (which usually drives a power amp or mixer).

IMPORTANT! When using the 3-pin Link connection, **remove the Headphones 1U module's rear-panel JP1 jumper and put it in a safe place**. This jumper is what normals the Headphones 1U module's Left input to its Right input when the Link connection is not used. Since the module feeding it (i.e., *Stereo Line Out 1U* or *Mixup*) has its own Left-to-Right normaling, 3-pin Link connections require removal of this jumper to achieve expected operation and optimum sonic fidelity.

If you're using the 3-pin Link cable to feed the Headphones 1U module and the JP1 jumper is removed, it's front panel input jacks are still active, however they are independently addressable. That is, a signal appearing at the Headphone 1U's Left Input feeds only the Left headphone channel, and a signal appearing at the module's right input feeds only the right headphone channel.

The following diagrams show how to connect a v2 Headphones 1U module to either a *Stereo Line Out 1U* module or a *Mixup* module's CHAIN OUT connector using the included 3-pin Link cable:

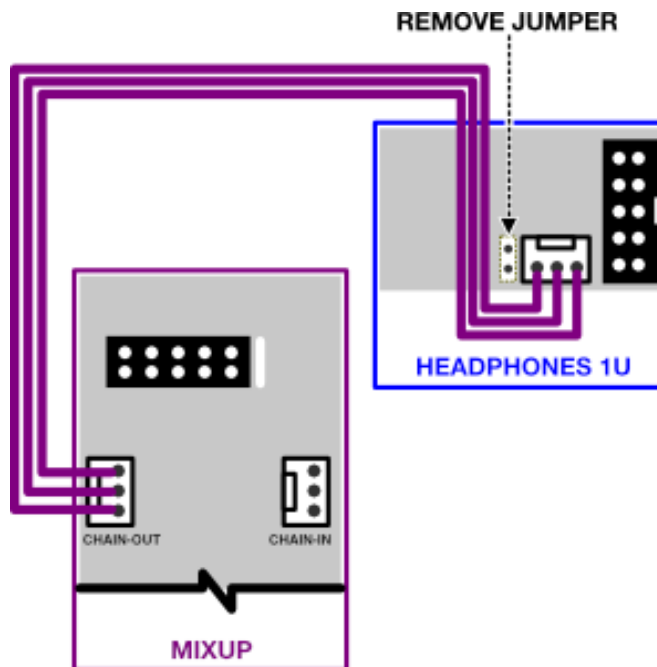
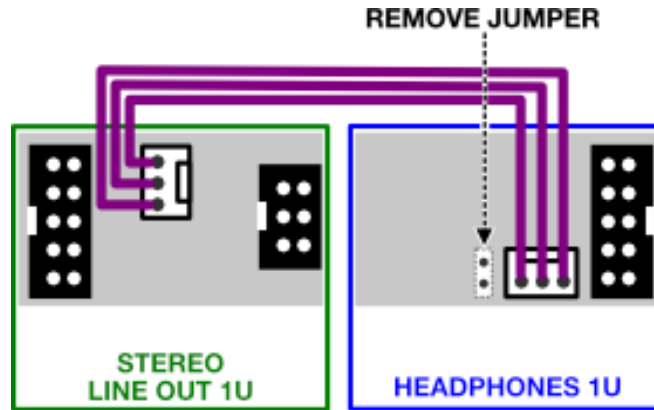

Technical Specifications

Version 2

Width	10 hp
Maximum Depth	37 mm (43 mm with 3pin cable inserted)
Current Draw	36 mA @ +12V 36 mA @ -12V

Version 1

Width	10 hp
Maximum Depth	34 mm
Current Draw	32 mA @ +12V 32 mA @ -12V