

MANATHER MANUAL

MALEKHO

814 SE 14TH AVENUE
PORTLAND OR 97214
USA

Version 1.0

SAFETY, MAINTENANCE & OVERVIEW

WARNING

To reduce the risk of electrical shock do not expose to water, rain or any moisture.

Do not use in direct sunlight.

Do not open the enclosure. If you require servicing, please contact Malekko directly.

Use only the 9V power AC adaptor provided with Manther.

Do not use around heat (stoves, furnaces etc.).

Do not use abrasive chemicals to clean your unit or OLED screen.

Do not apply unnecessary pressure to the OLED screen.

MANTHER is a full featured, tabletop monosynth with an analog signal path, an advanced 64-step digital sequencer and onboard delay. The heart of this beast is a coveted CEM3340 based VCO IC chip. The analog filter is based on an SSM2044 chip. The Source Mixer allows for total control over the Square, Triangle, Saw, Tri Shape, Noise and Sub Oscillator levels with individual wave outputs. Dial everything from heavy basslines to screaming leads to stomping kicks. Manther growls like no other.

Automation recording is available for parameters of the LFO, VCO, SOURCE MIXER, VCF, VCA, ENVELOPE as well as GLIDE and DELAY. Once automation is recorded it can be saved within a total of 64 presets. This allows for recall of intricate sound sculpting and numerous animated creations. Easily build songs by simply selecting presets to play in any order. Program notes quickly using the keyboard. Utilize the Repeat and Probability functions per step for a unique and inspiring approach to gate pattern formation. Even route the LFO to modulate the Delay time.

The intuitive menu offers additional control and setup of the more complex features: Sub Semitones, ADSR envelope, Sequence direction (FWD, REVERSE, PENDULUM and RANDOM), Sequence division and multiplication, LFO phase, additional Delay features, Clock settings and more.

INS and OUTS include: CV, MIDI, CLOCK, GATE and LFO and pairs brilliantly with Eurorack.

Features include:

- 64-step sequencer
- Keyboard with octave transpose controls
- Onboard Delay with Time, Mix, Regenerate and Sync controls
- Individual Outputs for Square, Saw and Triangle waveforms
- Mixer for Square, Triangle, Saw, Sub Osc and Noise
- Audio Input
- 4 banks of 16 presets each
- Song Mode
- Record automation of features per step for: LFO, VCO, DELAY, VCF, ADSR Envelope and GLIDE
- Gate Probability, Gate Repeat, Gate Delay and Accent per step
- Morph control over automation
- Route LFO to modulate delay time
- LFO Sync
- Assign modulation of Pulsewidth to LFO, Manual or Envelope
- Glide control per step
- FWD, REV, PENDULUM and RANDOMIZE sequence directions
- Tempo control
- Switches for LFO shape
- Switches for Envelope direction and VCA control
- Range switch
- Gate inputs and outputs
- LFO output
- CV inputs for VCO, VCF and VCA
- MIDI in and out
- Headphone Output

INDEX

FIRST STEPS	Pg. 1
INPUTS AND OUTPUTS	Pg. 2
ROUTING & WAVEFOLDING	Pg. 3
MENU	Pg. 4
LFO & MODULATION	Pg. 5
VCO & SOURCE MIXER	Pg. 6
VCF, VCA & ADSR ENVELOPE	Pg. 7
SEQUENCER, KEYBOARD & RECORDING	Pg. 8-9
PRESETS & DELAY	Pg. 10
SHIFT FUNCTIONS (Probability, Repeat, Delay, Gate, Accent, Copy)	Pg. 11
SONG MODE	Pg. 12-13
UPDATING YOUR MANTHER	Pg. 14
TEAM	Pg. 15
WARRANTY	Pg. 16

FIRST STEPS

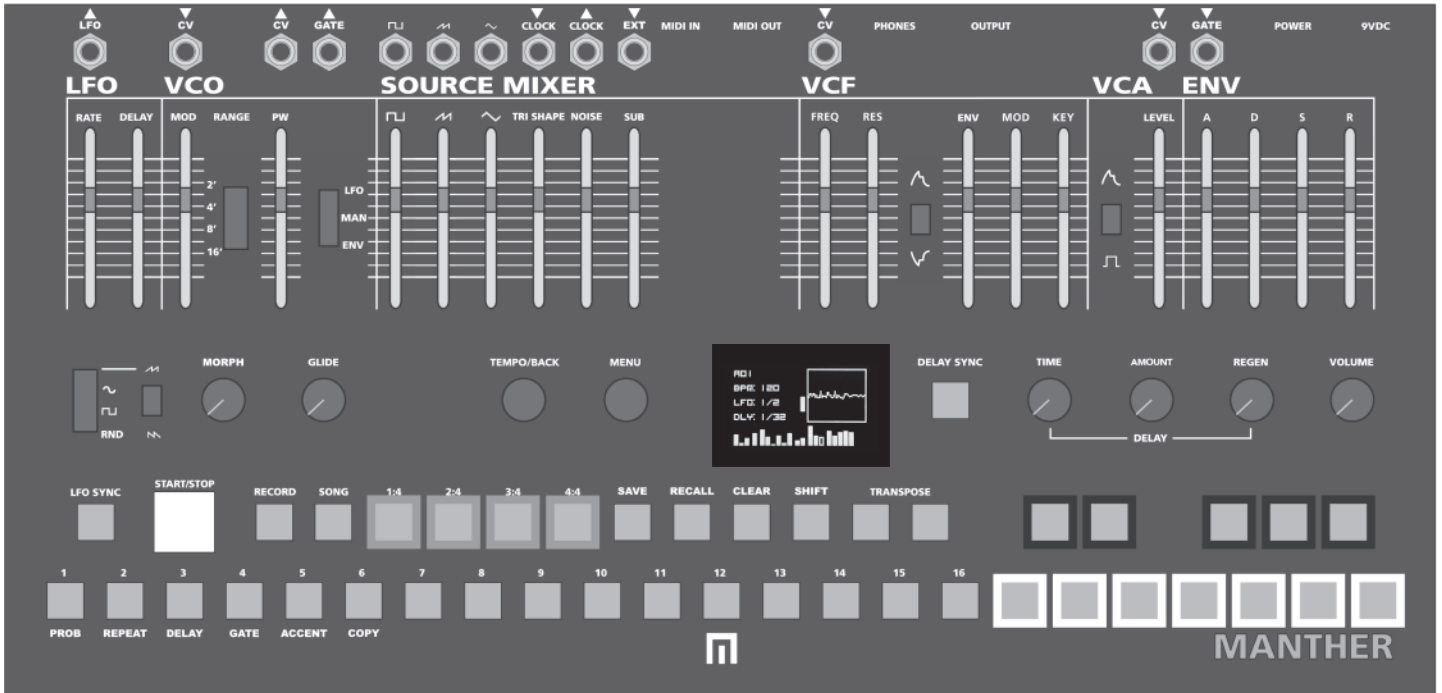

FIRST:

Connect your headphones or speakers to the headphone jack or main mono output jack. POWER UP YOUR UNIT. It will take a few seconds for Manther to initialize tuning and recall your memory settings.

PRESET INDICATOR: A (BANK A) and 01 (preset number 1)

BEATS PER MINUTE

LFO SETTING (synced/rate or "free").

The bar next to the waveform display also indicates modulation speed.

DELAY SETTINGS (synced/rate or "free")

BAR GRAPH DISPLAY OF FADER/CONTROL POSITIONS.

A clear bar indicates the last change made on a control.

Each bar will also indicate automation recording.



OUTPUT DISPLAY

PRESS THE START/STOP BUTTON. You will now see a blue light moving across each step button indicating playback.

MANTHER ships with some already programmed presets. To recall these presets, hold the RECALL button while selecting one of the sequencer/step buttons. If you want to clear a preset, simply select SHIFT and then CLEAR. You can save a now empty sequence by holding SAVE and one of the step buttons/preset slots.

THERE ARE TWO WAYS YOU CAN START RECORDING NOTES ON STEPS:

1. While the sequencer is playing, press the RECORD button and then play the keyboard - every time you press a key, a note will record on a step.
2. You can program steps on or off on the sequencer and then hold those lit buttons/steps while selecting notes on the keyboard.

- Once you have programmed some steps with notes, adjust the fader/control settings for the LFO, the VCO, the SOURCE MIXER, the VCF, VCA and ENVELOPE.
- Save your preset: HOLD SAVE, then select one of the sequencer buttons 1-16 to save to a slot.
- To expand your sequence to 32 steps on the fly, hold the 2:4 button and then select the 16th step button (which will copy the steps from 1:4 to 2:4). Now the sequencer is 32 steps. Do the same for 3:4 for 48 steps and 4:4 to expand to 64 steps.
- To record automation of fader changes, hold RECORD while moving controls. You will see the LED of the fader with automation recording is now lit red. To clear pre-recorded fader/control automation, hold the CLEAR button while moving automated fader or knob. The settings for that control will now return to the relative position on the actual hardware panel. You can automate all

MAKE SURE YOU HAVE THE LATEST FIRMWARE! SEE PG.13 FOR MORE INFO!

INPUTS & OUTPUTS

MANTHER was designed with 3.5mm jacks on the top of the enclosure for use with Eurorack modules and can also be linked with other external gear over MIDI using the two rear MIDI jacks.

- 1 LFO (Low Frequency Oscillator) OUTPUT:** Sends the LFO out
- 2 VCO (Voltage Controlled Oscillator) CV INPUT:** Receives 1v/Oct input from a Eurorack source or keyboard that supports this connection.
- 3 SEQUENCER CV OUTPUT:** Sends all notes out.
- 4 SEQUENCER GATE OUTPUT:** Gate output for notes played via the sequencer.
- 5 INDIVIDUAL SQUARE WAVE OUTPUT:** Sends this individual waveform/signal out for external mixing.
- 6 INDIVIDUAL SAW WAVE OUTPUT:** Sends this individual waveform/signal out for external mixing.
- 7 INDIVIDUAL TRIANGLE WAVE OUTPUT:** Sends this individual waveform/signal out for external mixing.
- 8 ANALOG CLOCK INPUT:** Receives external analog clock source; A Eurorack clock source, for instance.
- 9 ANALOG CLOCK OUTPUT:** Sends analog clock.

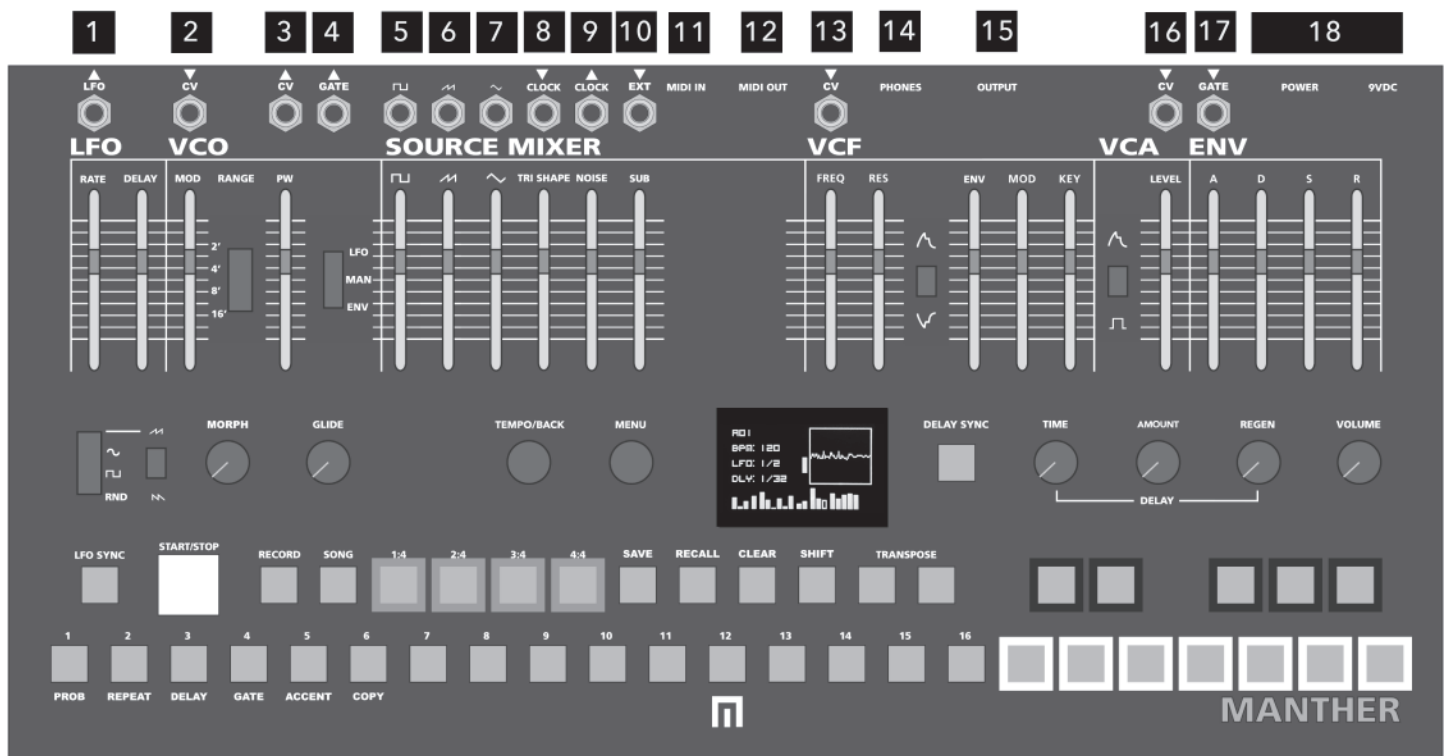

- 10 EXTERNAL AUDIO INPUT:** Connect to an external audio source for mixing with waveforms en route to VCF. Note: External Input is unity level.
- 11 MIDI INPUT:** Receives MIDI clock. CC messages are planned for a software future release.
- 12 MIDI OUTPUT:** Sends MIDI clock out.
- 13 VCF (Voltage Controlled Filter) CV INPUT:** Controls filter frequency cutoff from an external CV source. Sums with ENVELOPE, MODULATION and KEY at unity gain.
- 14 HEADPHONE OUTPUT:** Final audio output.
- 15 MAIN OUTPUT:** Final audio output.
- 16 VCA (Voltage Controlled Amplifier) CV INPUT:** Controls the amplitude of the VCA with external CV.
- 17 ENVELOPE GATE INPUT:** Receives gate inputs.
- 18 POWER IN and POWER ON/OFF BUTTON**

ROUTING & WAVEFOLDING

TRI FOLD

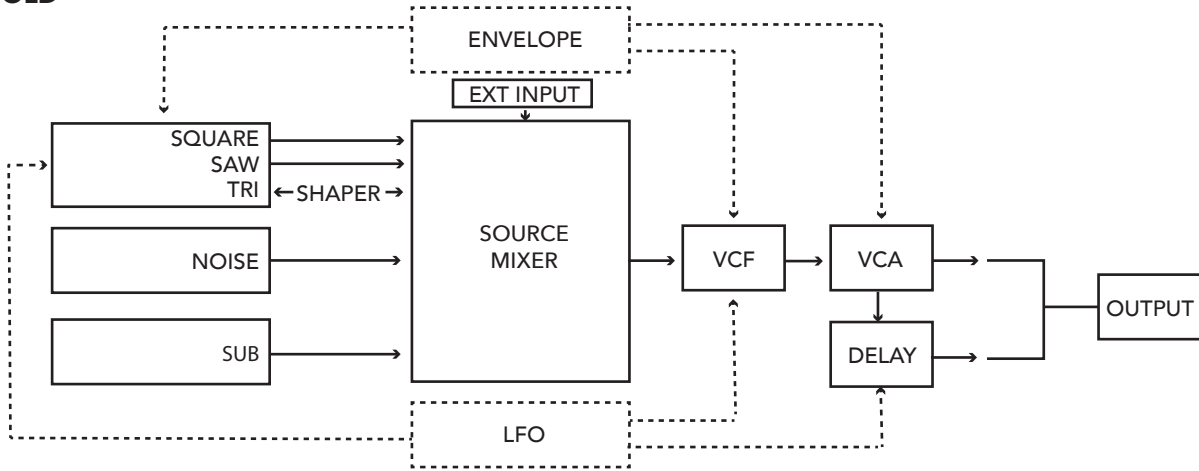

By default, Manther is set to TRI FOLD. This means that the control for TRI SHAPE will fold the TRIANGLE waveform.

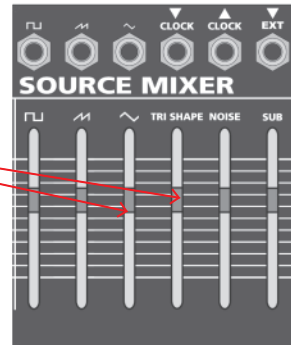

FOLD ALL

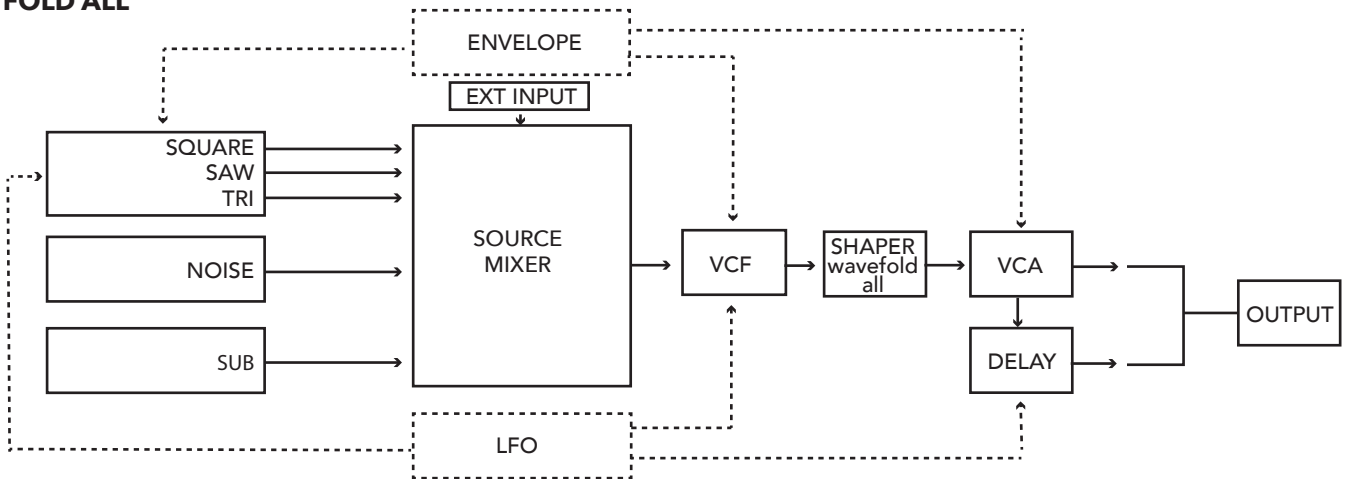

Manther wavefolding can be set to "FOLD ALL". This means the TRI SHAPE output control wavefolds the VCF. To access this routing feature, you can find it under the MENU > MIXER > WAVEFOLDER > VCF.

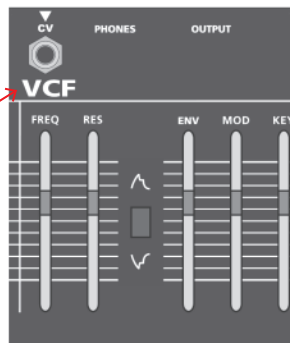
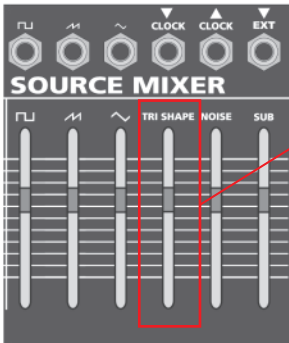

WAVEFOLDER	VCF
SUB SHAPE	97
SEMITONES	-12
CENTS	0

MENU

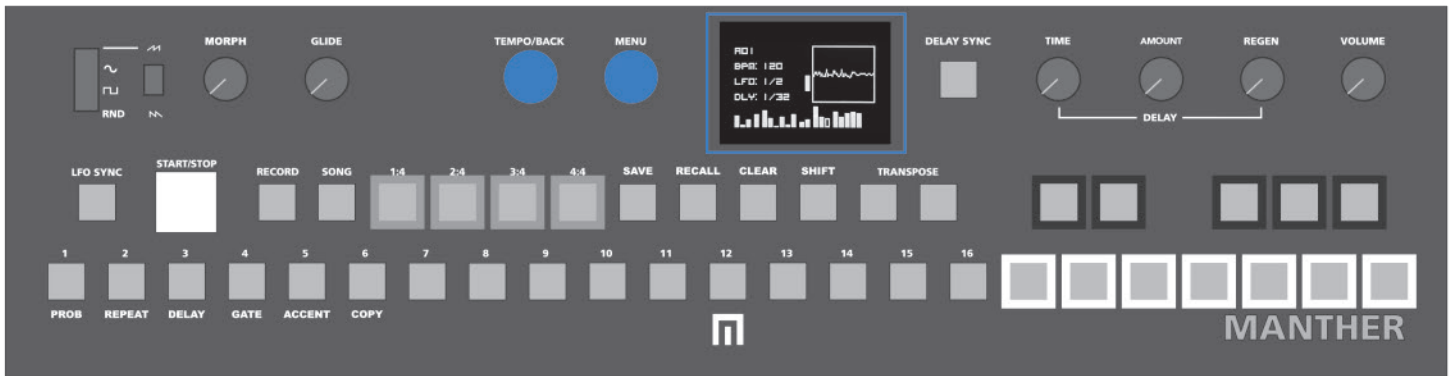

OLED / MENU

Press the **MENU** encoder to enter main MENU. Turn the MENU encoder to scroll through the menu list. Press the MENU encoder to select feature option. Press **TEMPO/BACK** to exit the menu or go back to a previous screen or option.

RECORD

Change UPDATE from ALL to NOTE specifically (default is set to ALL). This will switch automation recording from every step to just steps with active notes.

MIDI

MIDI IN CH: Sets the MIDI channel in from 1-16

NOTE: THIS SETTING IS THE ONLY MENU SETTING NOT SAVED WITHIN PRESETS.

DELAY

Sets DELAY maximum milliseconds.

LFO>DELAY (set LFO to modulate delay time).

MIXER

WAVEFOLDER TRI is default and can be changed to VCF where wavefolder folds signal after VCF (fold all).

SUB SHAPE changes sine to square. 0 (sine) to 100 (square).

SEMITONE changes semitones of SUB OSC.

CENTS changes semitones of SUB OSC in cents (fine tuning).

LFO

PHASE adjust phase of the LFO.

KEY SYNC change key sync of LFO to ON. OFF is default.

SEQUENCE

SEQUENCE LENGTH: Change from 1-64 steps.

DIRECTION: Sequence direction options are FWD, REVERSE, PENDULUM and RANDOM.

DIVIDE: Divide sequence time.

MULTIPLY: Multiply sequence time.

RECALL: You can set a preset of sequences to recall NOW (instant) or by BAR (recalled preset will play after the current preset sequence ends).

CLOCK

Change clock from INT (Internal) default, to MIDI CLOCK, ANA (Analog).

ABOUT

Manther Firmware Version

LFO & MODULATION

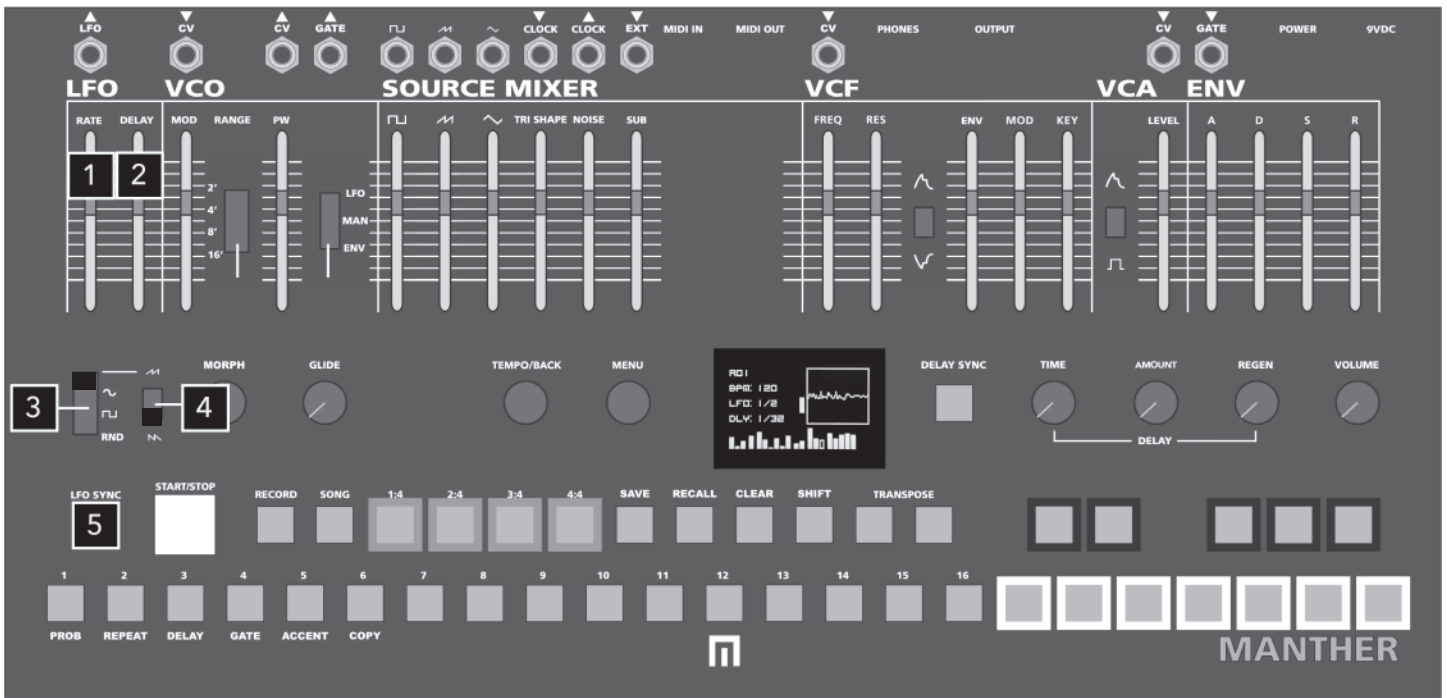

LFO

The LFO can modulate the VCO, SQUAREWAVE PULSEWIDTH, VCF and DELAY (see MENU to assign LFO to modulate DELAY).

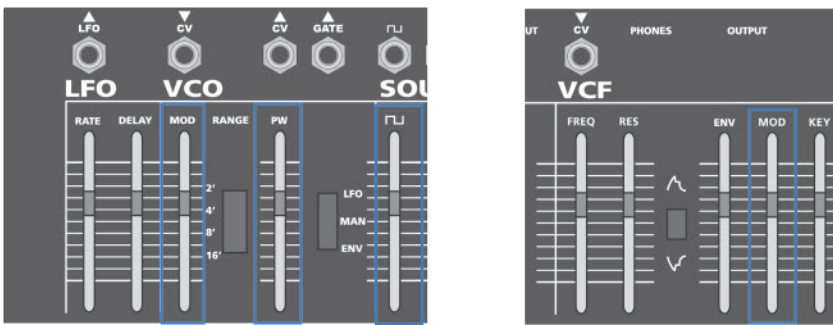

1 LFO RATE CONTROL

Controls LFO speed from minimum to maximum speed.

2 LFO DELAY CONTROL

The DELAY SLIDER will control the amount of time between a note or a key press and when the LFO ramps up to its full amplitude. When SYNC is OFF, delay range is approximately 20ms to ~3 seconds.

3 LFO WAVEFORM SWITCH

Selects the LFO waveform shape. RAMP wave, SINE wave, SQUARE wave, and RANDOM are all available as modulation shapes. Additionally, there is a switch to invert the ramp wave into a sawtooth wave.

4 INVERT LFO RAMP SWITCH (SAWTOOTH)

Set #3 switch to the top setting, then adjust this RAMP switch (#4).

5 LFO SYNC ON/OFF

Press to turn on LFO sync (LFO syncs to BPM).

You can access additional LFO parameters in the MENU > LFO:

PHASE adjust the starting phase of the LFO: 0=ZERO PHASE. You can adjust this up to 100.

KEY SYNC set to ON resets the LFO start point when a note is played. OFF is default.

LFO TO DELAY:

MENU > DELAY > LFO > DELAY: Now select 0-100 to apply LFO modulation to the DELAY TIME.



VCO & SOURCE MIXER

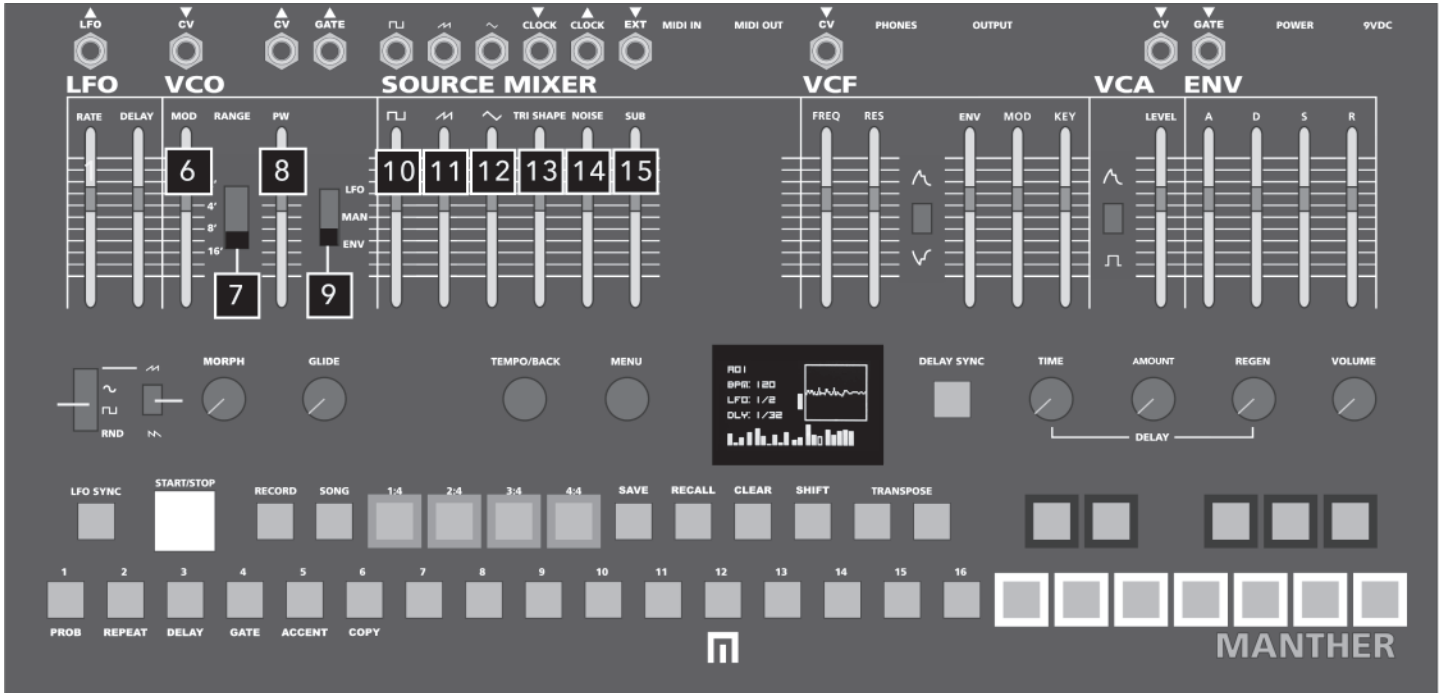

VCO

The VCO is the main sound source for the MANTHER. It outputs SQUARE, SAW, TRIANGLE, NOISE AND SUB OSCILLATOR to the SOURCE MIXER for further control.

6 VCO FREQUENCY MODULATION

Turning the VCO MODULATION SLIDER up increases the amount of LFO modulation applied to the VCO's frequency.

7 VCO OCTAVE RANGE SWITCH

16' tracks with SEQUENCER and MIDI notes, 8' is an octave above, 4' is two octaves above, and 2' is three octaves above.

8 VCO PULSEWIDTH SLIDER

When PWM SOURCE SWITCH (#9) is set to MANUAL, the PW AMOUNT SLIDER varies the pulsewidth of the square wave. When the PWM SOURCE SWITCH is set to LFO or ENV, the PW AMOUNT SLIDER acts as an attenuator for pulsewidth modulation.

9 VCO PULSEWIDTH MODULATION SWITCH

Switch between LFO, MANUAL or ENVELOPE to control pulsewidth of the SQUARE WAVE. See #8 above for additional info.

SOURCE MIXER

SQUARE, SAW and TRIANGLE waveforms are summed together along with NOISE and SUB OSCILLATOR. Here you can control the volume of each waveform in this mix. TRI SHAPE controls the character and amplitude of the TRIANGLE waveform.

10 SQUARE WAVE LEVEL

11 SAW WAVE LEVEL

12 TRIANGLE WAVE LEVEL

13 TRIANGLE SHAPE / WAVEFOLD CONTROL

14 NOISE LEVEL

15 SUB OSC LEVEL

Additional SOURCE MIXER parameters in the MENU:

WAVEFOLDER: The TRI setting is default (wavefolding of triangle) and can be changed to VCF where wavefolder folds signal after VCF (fold all).

SUB SHAPE: Changes the sub oscillator from 0 (sine) to 100 (square) mix

SEMITONE: Changes semitones of sub oscillator.

CENTS: Changes semitones of sub oscillator in cents (fine tuning).

WAVEFOLDER	TRI
SUB SHAPE	97
SEMITONES	-12
CENTS	0

VCF, VCA & ADSR ENVELOPE

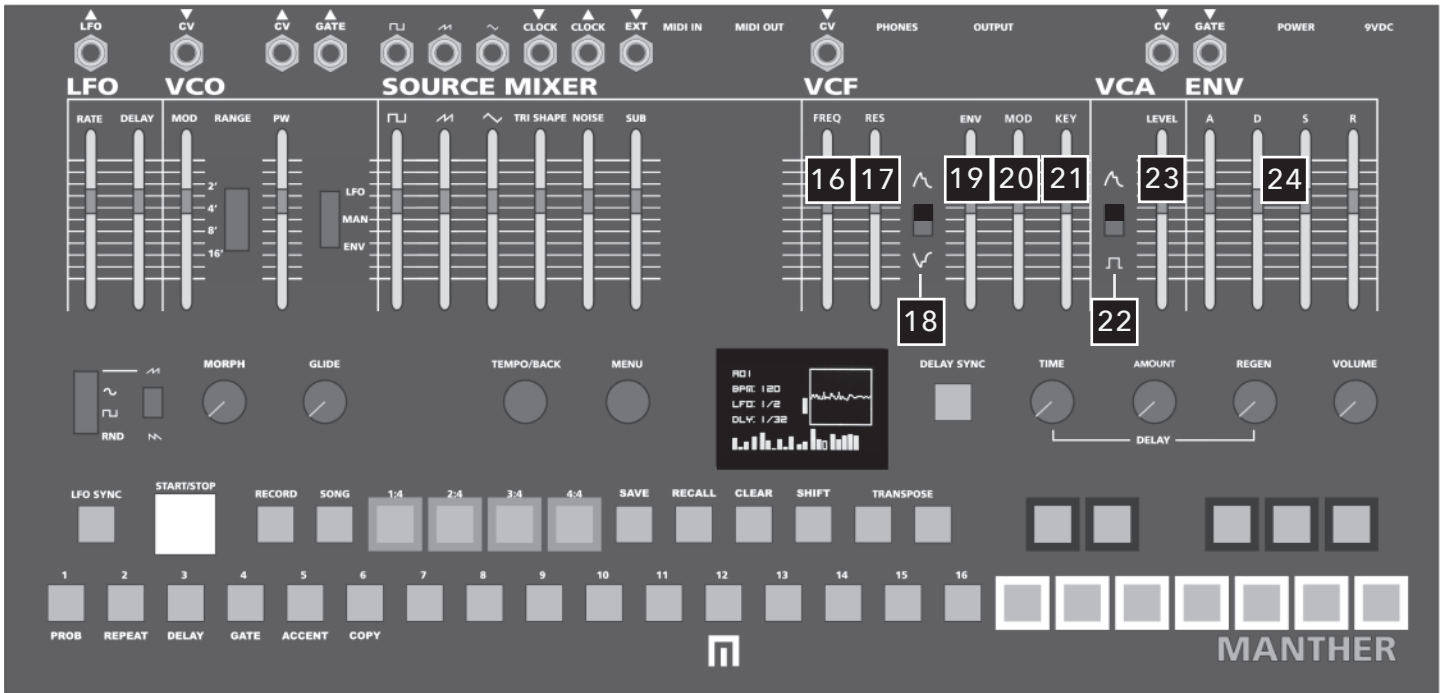

VCF

16 VCF CUTOFF FREQUENCY SLIDER

Manual control of filter cutoff frequency. Sums with VCF modulation mixer (ENV, MOD, KEY) and VCF CV IN input.

17 VCF RESONANCE CONTROL

Sets filter resonance.

18 VCF/ENVELOPE MODULATION SWITCH

Switch the ENVELOPE to either positively or negatively modulate the VCF (UP position is positive).

19 VCF/ENVELOPE MODULATION CONTROL

Controls the amount of modulation applied to filter frequency cutoff from the envelope generated by the ENVELOPE section.

20 LFO TO VCF MODULATION CONTROL

Controls the amount the LFO modulates the VCF.

21 VCF KEYTRACKING CONTROL

Controls the amount of sequencer pitch CV applied to the VCF.

VCA

22 VCA ENVELOPE/GATE MODE SWITCH

Switches VCA control between ENV and GATE mode. In ENV mode the ENV section's ADSR controls the amplitude of the VCA. In GATE mode, a gate signal is generated whenever a key is pressed or a sequencer note is played, bringing the VCA to maximum amplitude.

23 VCA LEVEL CONTROL

Down position for zero amplitude and up position for full amplitude.

ENVELOPE

24 ADSR ENVELOPE CONTROLS

Control over Attack, Decay, Sustain and Release. For instance, Attack in down position for the shortest attack.

KEYBOARD, SEQUENCER & RECORDING

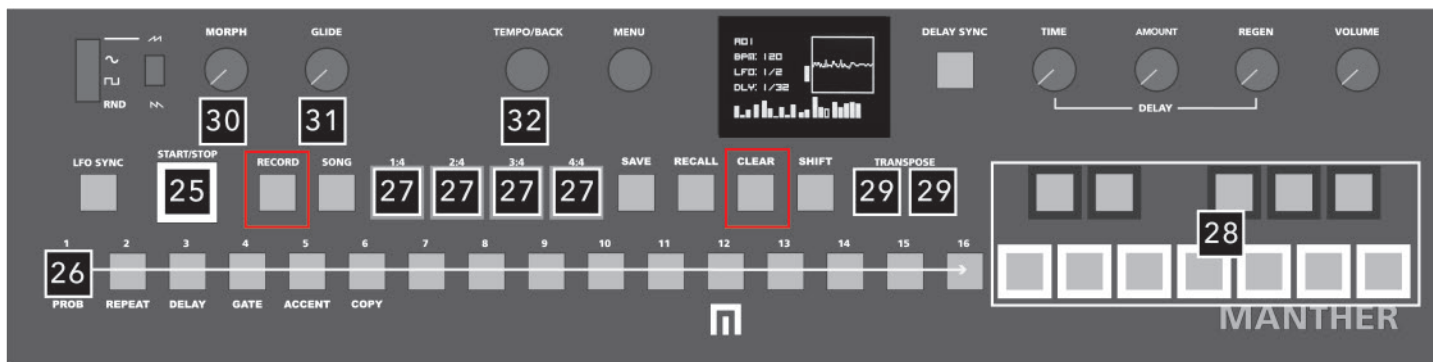

25 START/STOP

Starts and stops sequencer.

26 STEP AND PRESET BUTTONS

Each step can include notes and various automated information. Step buttons also act as preset slots. For more information on saving presets see pg. 10.

RECORDING NOTES IN A SEQUENCE

You can record notes played on the keyboard by pressing the RECORD button once (so it is lit). Now you can press the START/STOP button on the sequencer and when notes are played on the keyboard, they are recorded to sequencer steps 1 thru 16.

To EXIT record mode press RECORD again.

You can also record notes while the sequencer is stopped. Hold a step while selecting a note on the keyboard. That note will now be recorded on that step.

If you want to clear a recorded step, press that step off (step will no longer be lit).

27 SEQUENCE ACCESS (1:4,2:4,3:4,4:4) AND PRESET BANK ACCESS

Expand your sequence from 16 steps to 64 steps total. To create a 32 step sequence, hold 2:4 and then press step 16. You now have a 32 step long sequence. Steps 1-16 are automatically copied to steps 17-32 as a starting point. You can create any length of sequence this way (up to 64 steps), by holding a SEQUENCE ACCESS button and selecting any step button. For instance, if you want to create a shorter length sequence, say 8 steps, hold 1:4 and step 8.

These buttons are also used to access BANKS of presets. See pg. 10 for more information on banks of presets.

During playback, the audible section button/indicator will be lit solid blue. The section currently selected for editing will flash blue.

28 KEYBOARD

Play notes, record notes into sequences, and edit notes in sequences. Lit buttons indicate the note playing per step.

29 TRANSPOSE OCTAVE

Select these buttons to change the keyboard octave up or down. They will flash faster as you reach the lowest or highest available octaves.

30 MORPH CONTROL

Control over global skew. Use this to slowly morph through recorded automation.

NOTE: IF YOU FEEL LIKE YOUR MANTHER IS NOT RESPONDING AS QUICKLY AS IT SHOULD TO VARIOUS CONTROLS, YOU PROBABLY HAVE THE MORPH KNOB TURNED UP. TURN IT DOWN! It is best to adjust the MORPH feature after you have recorded automation.

31 GLIDE CONTROL

Glide adds smooth pitch transition. "Global" GLIDE can be applied or each step can be programmed with an individual GLIDE amount by holding a step button while adjusting the GLIDE control.

32 TEMPO/BACK

Turn to change tempo/BPM. Also pressing this encoder while in MENU mode will EXIT MENU.

KEYBOARD, SEQUENCER & RECORDING CONTINUED

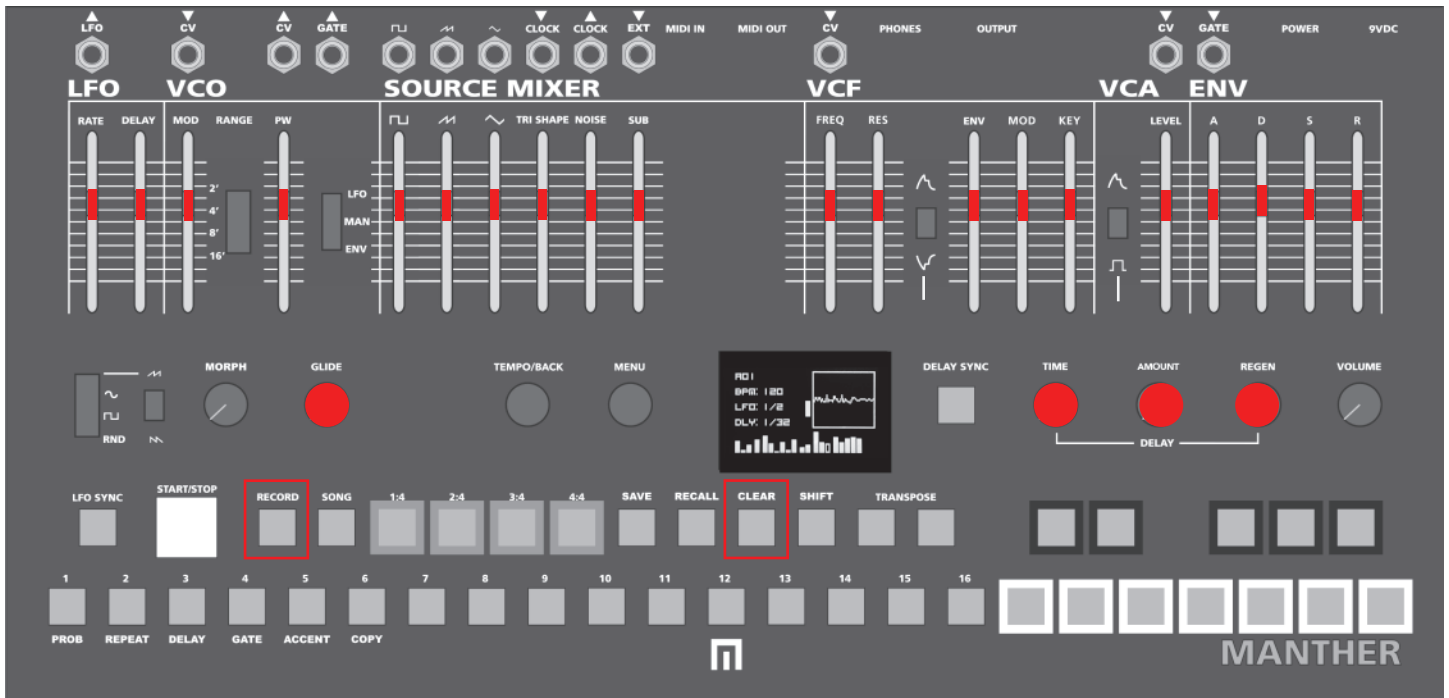

Additional SEQUENCE parameters in the MENU:

LENGTH: Changes the length of a sequence from 1 step to 64 steps total.

DIRECTION: Changes direction of sequence playback to FORWARD, REVERSE, PENDULUM or RANDOM.

DIVIDE: Divides the sequence down to 8.

MULTIPLY: Multiplies the sequence up to 8.

LENGTH:	36
DIRECTION:	FWD
DIVIDE:	2
MULTIPLY:	3

AUTOMATION RECORDING

You can record animated changes to all of the Manther features marked in red. By default, automation records on all steps. Under MENU > RECORD > UPDATE > ALL you can change ALL to NOTE specifically. This will switch automation recording from every step to just steps with active notes.

Hold the RECORD button while moving the controls for the features you wish to automate. Each step will then retain those automated control movements. Once you record automation to a control, release the RECORD button and those controls with red LEDs will now be lit red (knobs have no LED indicators but automation can be recorded for these controls with the exception of MORPH, VOLUME and MENU controls). Now your control changes will play back automatically as the sequencer plays.

If you want to CLEAR AUTOMATION for a given parameter, hold the CLEAR button while selecting the control. The LED will no longer be red indicating that automation has now been cleared for those controls that have LEDs. If you want to clear all recorded automation press CLEAR + RECORD.

NOTE: IF YOU DON'T WANT TO LOSE WHAT YOU HAVE JUST RECORDED, SAVE IT TO A PRESET BY HOLDING SAVE AND ONE OF THE SEQUENCER/PRESET BUTTONS 1-16. MORE PRESET INFO ON PAGE 10.

PRESETS & DELAY

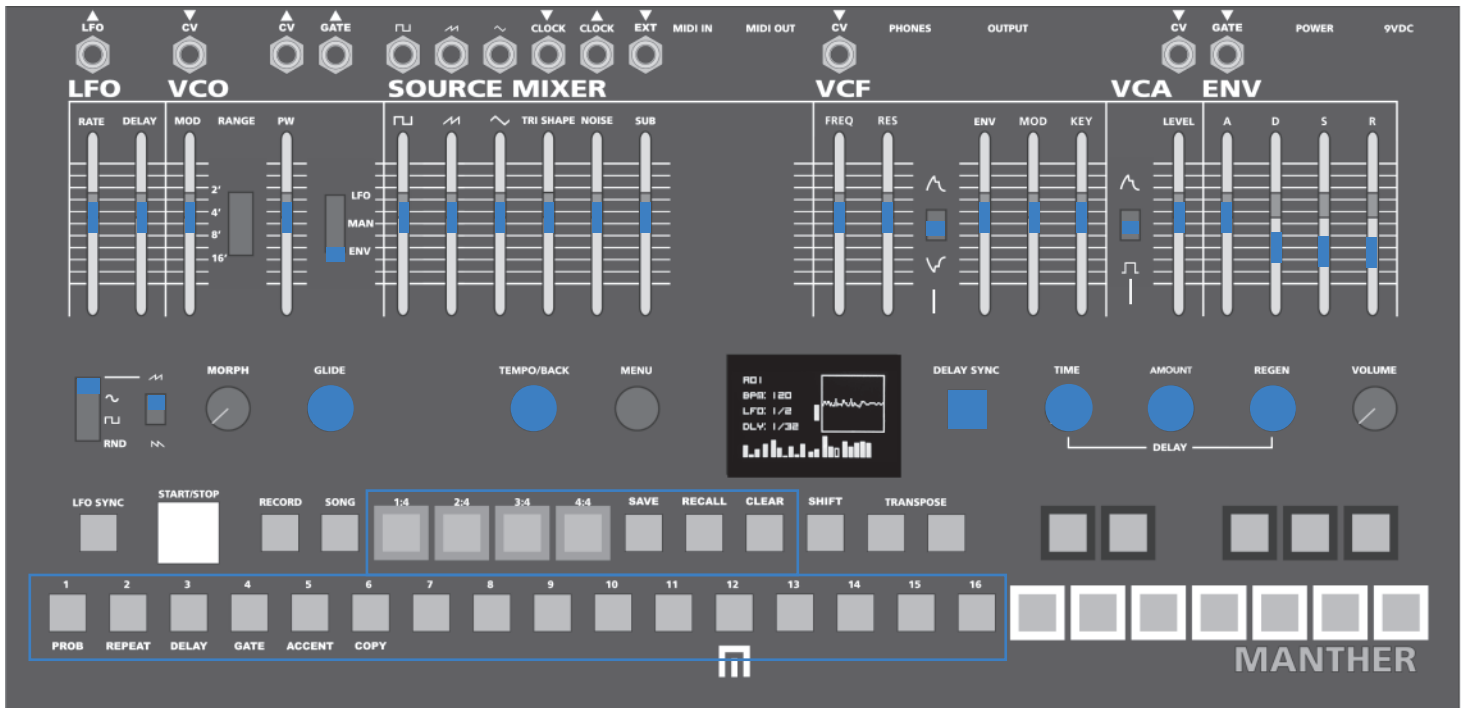

SAVE PRESET

Each step button also acts as a preset slot and SEQUENCE ACCESS buttons (1:4, 2:4, 3:4, 4:4) also act as preset banks. There are a total of 64 available preset slots (16 per bank). To save a preset hold the SAVE button while selecting a preset slot. A preset is saved properly when you see the SAVING prompt on the OLED screen. To save to a new BANK of presets, hold SAVE while selecting the bank (1:4, 2:4, 3:4 or 4:4), then release the bank button, and then select a preset slot. Presets save all parameters marked in BLUE including automation, all step programming, and all menu settings with the exception of octave range switch settings, volume control settings and MIDI settings.

RECALL PRESET

To recall a preset, hold RECALL while selecting saved presets on buttons 1-16. To recall from another BANK of presets, hold RECALL while selecting the bank (1:4, 2:4, 3:4, 4:4), continue to hold RECALL and then the preset slot/button. You will need to release the RECALL button and press it again in between switching banks/recalling.

There is a setting under MENU > SEQUENCE > RECALL where you can change recall from NOW (instant) to BAR (recalled preset will play after the current preset sequence ends).

CLEAR PRESET

To clear a preset, hold SHIFT + CLEAR while in a particular preset. You can also overwrite an existing preset by saving current settings to the existing preset.

DELAY SYNC

Press the DELAY SYNC button to sync the DELAY to clock.

DELAY TIME

Adjusts the DELAY TIME in divisions of clock when DELAY SYNC is on. Available synced delay times are: 1/32, 1/32., 1/32T, 1/16, 1/16., 1/16T, 1/4, 1/4., 1/4T.

In >30ms "FREE" mode, delay is from 30ms to 600ms. In <15ms "FREE" mode, delay is approx 5ms to 30ms. See DELAY MENU to change ms modes.

DELAY AMOUNT

Mixes delay in output signal.

DELAY REGENERATION

Adjust to change amount the delay regenerates. Great for creating feedback.



Additional DELAY parameters in the MENU:

DELAY TYPE: You can change between 30 to 15 ms modes.

DELAY TYPE >30MS

LFO>DELAY: Assign the LFO to modulate the delay time by adjusting this setting from 0 to 100.

LFO>DELAY 30

SHIFT FUNCTIONS

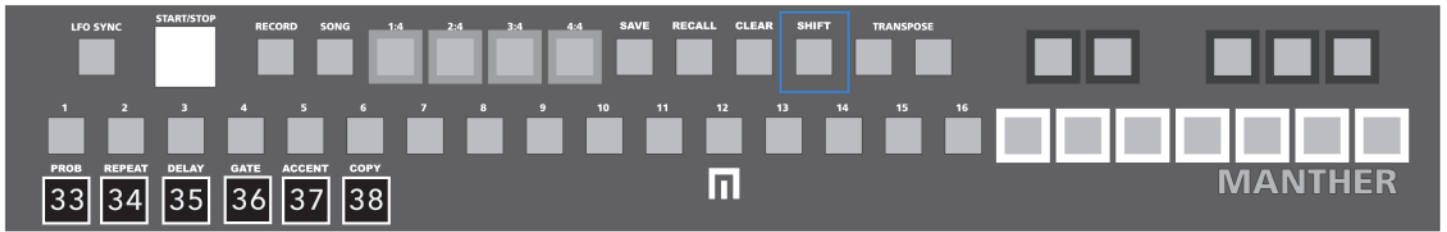

Once you've recorded some steps in a sequence you can dive into more specific editing details by accessing the shift functions.

33 PROBABILITY MODE

SHIFT + PROBABILITY button will access menu for programming the probability that a particular step will fire.

PROBABILITY | 50

STEPS 1-16



Turn the MENU encoder to change the level of probability a GATE will fire (default is set to 100). Push down the MENU encoder while moving it for even finer adjustments. Then press one of the STEP buttons to assign that probability level to that step. To EXIT press SHIFT again.

34 REPEAT MODE

SHIFT + REPEAT button will access menu for programming amount of repeats per step.

REPEAT | 2

STEPS 1-16



Turn the MENU encoder to change the amount a step will REPEAT (1-4 repeats are available). Then press one of the STEP buttons to assign that repeat count to that step. To EXIT press SHIFT again.

35 GATE DELAY MODE

SHIFT + DELAY button will access menu for programming amount of gate delay per step.

DELAY | 80

STEPS 1-16



Turn the MENU encoder to change the amount a step will DELAY (1-100). Push down the MENU encoder while moving it for even finer adjustments. Then press one of the STEP buttons to assign that repeat count to that step. To EXIT press SHIFT again.

36 GATE MODE

SHIFT + GATE button will access menu for programming gates and gate time per step. By default, gates are ON for each step.

GATE TIME | 80

STEPS 1-16



Turn the MENU encoder to change the gate length (1-100 and default is set to 50). Push down the MENU encoder while moving it for even finer adjustments. Then press one of the STEP buttons to assign that gate length to that step. To EXIT press SHIFT again.

37 ACCENT MODE

SHIFT + GATE button will access menu for programming gates and gate time per step. By default, gates are ON for each step.

ACCENT | 80

STEPS 1-16



Turn the MENU encoder to change the gate length (1-100). Push down the MENU encoder while moving it for even finer adjustments. Then press one of the STEP buttons to assign the accent to that step. To EXIT press SHIFT again.

38 COPY MODE

SHIFT + COPY to enter mode then select the step you want to copy, then the step you want to copy to. To EXIT press SHIFT again.

COPY STEP

FROM: 1

TO: 3

SONG MODE

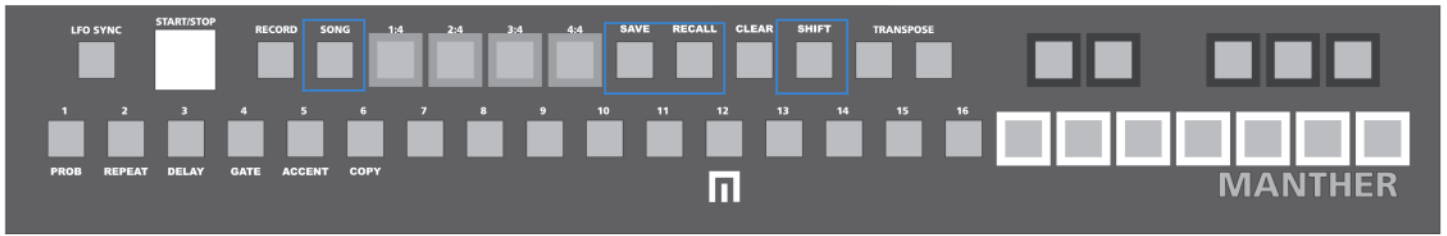

SONG MODE is used for playing presets automatically, thus creating a song. It can be comprised of all presets within all 4 banks. SONGS can be programmed in two ways: Hold down the SONG button while selecting presets. You can select a preset to repeat by pressing that button multiple times. To play your newly programmed song, you must then press the SONG button so it is lit and then press the START/STOP button to start playback. You can also build songs from multiple banks of presets hold SHIFT + SONG MODE. You will now be able to program the following:

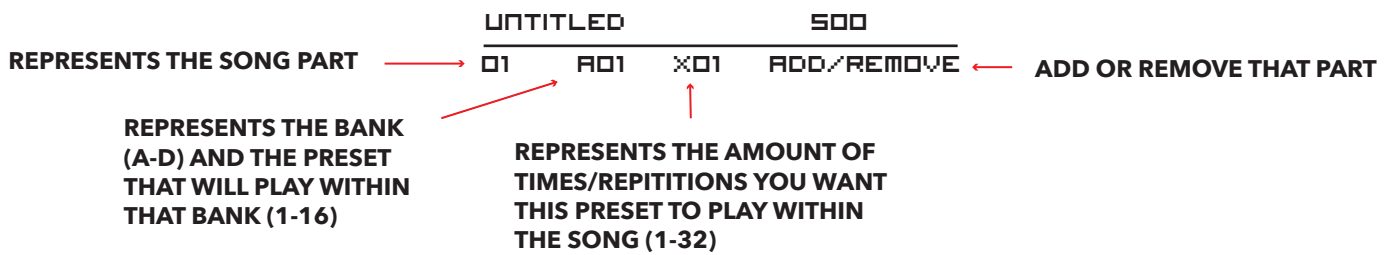

Use the MENU and TEMPO/BACK encoders (push down and rotate) to navigate through the SONG MODE features. Once you have programmed the BANK/PRESET for SONG PART 01 and the amount of times you want this preset to repeat, you will be prompted to ADD another part. Press the MENU encoder down to ADD the a new SONG PART (02) will appear and so forth.

UNTITLED	500
01	A01
X01	ADD
02	A01
X01	ADD

If you want to REMOVE a part that you've added to the song, scroll to the part you want to remove, press the MENU encoder until you get to ADD and then turn the MENU encoder so that instead of ADD, you see REMOVE. Then press MENU again.

UNTITLED	500
01	A02
X01	REMOVE
02	B01
X02	REMOVE
03	A01
X01	REMOVE

If you want to remove a part that you've added to the song, scroll to the part you want to remove, press the MENU encoder until you get to ADD and then turn the MENU knob so that instead of ADD, you see REMOVE. Then press the MENU button again. That part will now be removed from the song.

To EXIT SONG MODE in the menu, press SHIFT.

To SAVE a newly programmed song to it's own file for future recall, HOLD SAVE + SONG. You can add a title by using the MENU control.

SAVE SONG	
TITLE	ENTER TEXT
LOCATION	S01
SAVE	

SONG MODE

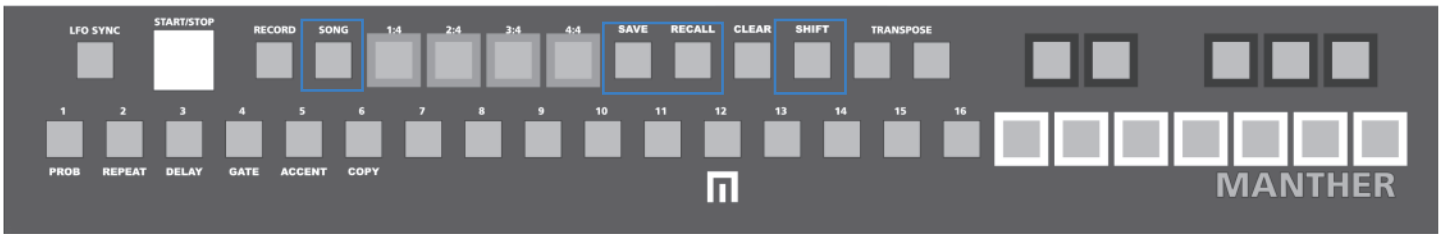

To RECALL a song, HOLD RECALL + SONG to enter the SONG locations mode. Now you can scroll through various songs using the MENU control. Press the MENU encoder to select the song you want to play. Press the song button so it's lit. Now press play.

RECALL SONG

```
01  MYSONG
02  MYSONG2
```

To CLEAR a song, HOLD CLEAR + SONG.

NOTE: Patterns that are set to RANDOM sequencing will never forward to the next programmed preset within a song. Because of the random behavior, they have no pattern end.

In song mode, this indicates the preset that is playing.

This indicates the preset that will load next.

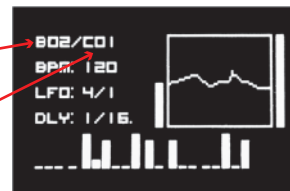

UPDATING YOUR MANTHER

Manther firmware will be periodically updated. These updates are delivered to Manther via the GATE input as packets of data included in a .wav audio file.

INSTRUCTIONS TO UPDATE:

1. Download the latest firmware update from the Malekko site to your computer or even your phone.
2. Power down the Manther.
3. Connect a 3.5mm cable from the audio source (audio interface or phone) to the Manther GATE input jack. Turn the volume of your sound source to max output. NOTE: If you are connecting to your phone, make sure you are in airplane mode and no other sounds will occur during the update or you will receive errors. If you are connecting to an audio source on your computer, you will need to should connect directly from an audio interface with more gain control (going directly out from a 3.5mm output jack on your computer might not be loud enough and you will receive errors).
4. Now hold down the 16th step button while powering up.

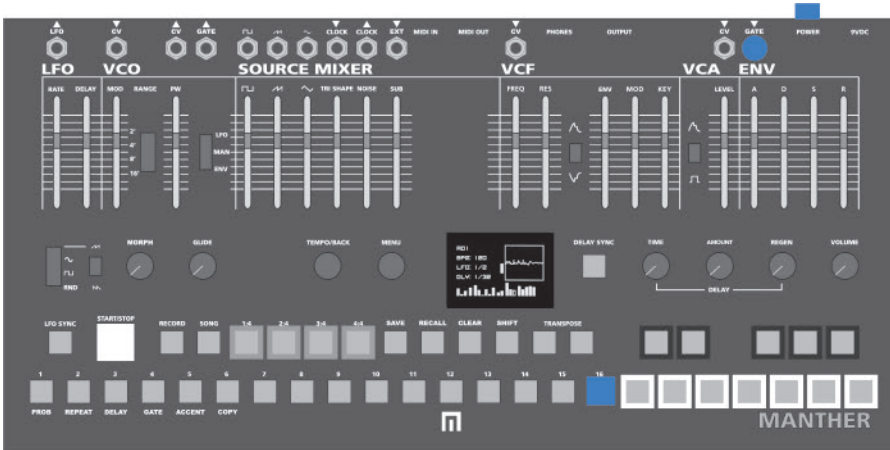

5. You will now see the following screen info and once you do release the 16th step button:

```
Audio Updater
State: WAITING
Decoder: SYNCING
Pkts Rec: 0
Errors: 0
```

6. MAKE SURE YOU DON'T HAVE YOUR SPEAKERS TURNED UP as the file is very loud! You can now play the .wav file. If you interrupt the audio in any way and see errors, you will need to start over (power down and perform steps 3-8).

7. Once Manther is receiving the new firmware correctly you will see the following information:

```
Audio Updater
State: RECEIVING
Decoder: DECODING
Pkts Rec: 226
Errors: 0
```

8. Once the screen stops receiving all packets (packet total will be listed with the firmware download), unplug the 3.5mm cable and restart. You now have the latest firmware installed and will see the new version under MENU > ABOUT. If you do receive errors, don't worry you won't brick your unit. You likely just need to boost the output of your sound source, reset your cable connection and try again (power down and perform steps 3-8).

Massive thanks to everyone on the team: Ben Davis, Austin Lightfoot, Julia aka The Synth Witch, Scott Goodwin, Rico Loverde, Jay Schwab, Andrew Dobbels, Anna Sitko, Brian Kirby, Devin Walsh, Sarah Holley, McKenzie Gaby, Steve Hamari, Corey Bauer, Chris Forns & Baseck.

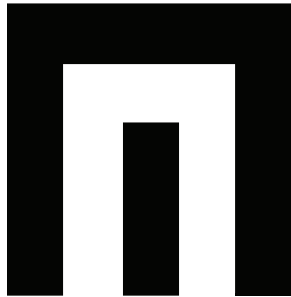

WARRANTY

This product is covered by the Malekko Heavy Industry warranty for one year following the date of purchase. This warranty covers any defect in the manufacturing of this product. This warranty does not cover any damage or malfunction caused by incorrect use such as, but not limited to the use of incorrect power supplies, excessive voltage levels, or exposure to extreme temperature or moisture levels. The warranty covers replacement or repair, as decided by Malekko Heavy Industry.

Please visit our website malekkoheavyindustry.com to obtain full warranty information and to register your product for coverage.