

PLASMA RACK



MANUAL

G A M E C H A N G E R | A U D I O

Thank you for purchasing the PLASMA Rack!

Our job at GAMECHANGER AUDIO is to invent and build new, exciting music technology that not only sounds great, but also inspires musicians and engineers to break new ground.

PLASMA Rack is the result over 2 years of research and development, dozens of prototypes and an incalculable amount of hard work.

We are all very happy with the result - the PLASMA Rack is a beast. It sounds absolutely astounding.

Plus, no one got electrocuted.

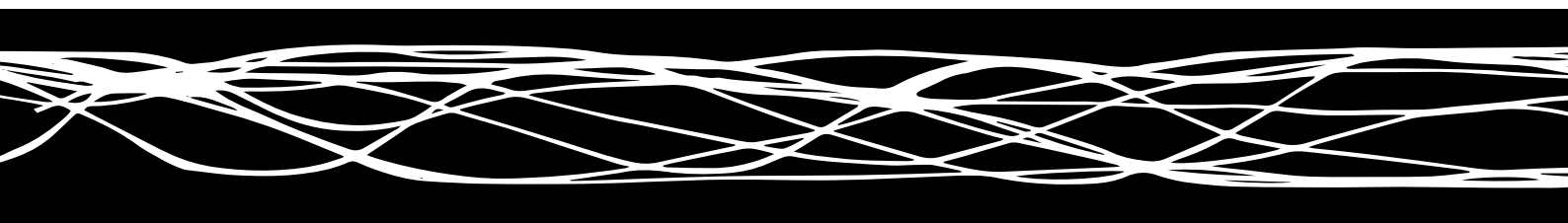

**Enjoy your brand new PLASMA Rack, and
- Keep on Rockin' in the Gluten-Free World -**

| | |
|---|----|
| MESSAGE..... | 1 |
| TABLE OF CONTENTS..... | 2 |
| PLASMA TECHNOLOGY..... | 3 |
| FEATURES..... | 4 |
| FRONT PANEL (DIAGRAM)..... | 5 |
| BACK PANEL (DIAGRAM)..... | 6 |
| FRONT PANEL CONTROLS..... | 7 |
| GAIN VOLTAGE AND BLEND..... | 7 |
| EQUALIZER, VOLUME AND UTILITY BUTTONS..... | 8 |
| SUSTAIN, OVERSATURATE AND CLEAN GATE..... | 9 |
| TREMOLO..... | 10 |
| BACK PANEL..... | 11 |
| MIDI CONTROLS..... | 13 |
| EXPRESSION PEDAL INPUT..... | 14 |
| DEFAULT BUTTON STATES..... | 15 |
| CLEAN / DIRTY TOGGLE AND FACTORY RESET..... | 16 |
| USING TWO PLASMA RACKS..... | 17 |
| TECH SPECS..... | 18 |
| MIDI CONTROL TABLE..... | 20 |
| SAFETY WARNING..... | 21 |
| LEGAL AND DISCLAIMER..... | 22 |

A significant expansion of the unique High Voltage Distortion concept behind PLASMA Pedal - The PLASMA RACK is a 1U sized high-end audio effects unit designed for professional and studio use.

Instead of using LED circuits, transistors or vacuum tubes to produce overdrive, the PLASMA RACK uses a fly-back coil transformer to express your instrument's live signal as a series of continuous high-voltage discharges within a xenon-filled tube.

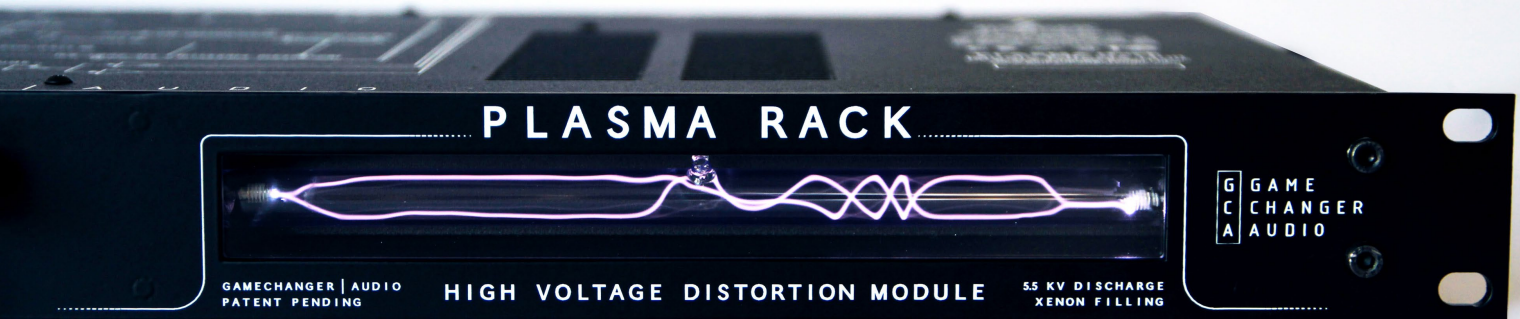

In essence – you are playing a bolt of electricity, and the electrical discharges produced by your instrument are instantly converted back into an analog audio signal.

The result is a quick, responsive, and extremely heavy distortion with Tons of unique character and a very powerful noise-gating effect.

3 band EQ:

Gives you more tweakability and control over sound

Input Gain control:

Can be used to fine-tune the PLASMA RACK for any type of input signal (different pickups etc.)

Sustain Mode:

Lets you achieve long sustained notes even at Low-Voltage settings

Oversaturate Mode:

Octave up / Overtone effect achieved by overpowering the PLASMA Tube

Clean Gate Mode:

Use the PLASMA Tube's gating effect on any CLEAN Signal without the added Distortion.

Built-in PLASMA Tremolo:

A unique Tremolo and Ring Mod effect, with adjustable Depth and Dynamic response.

Built-In Distortion Channel:

A special button combination lets you add some High-Class Op Amp dirt to your Dry signal

3 FX Loops with switchable level control:

Modify the signal path by inserting external effects into various parts of the PLASMA Rack's signal chain

Connectivity:

Two Inputs (incl. Balanced Input with PAD), Two Outputs, MIDI In, Through, and Out ports

Full MIDI Control + 8 Preset slots:

Control all parameters and values via CC Messages and Program Change Messages with 8 Preset slots.

Assignable Expression input:

Any potentiometer on the PLASMA Rack can be assigned to an Expression pedal

Savable utility settings

Make your PLASMA Rack gig-ready by setting up the default boot-up states of all buttons and functions.

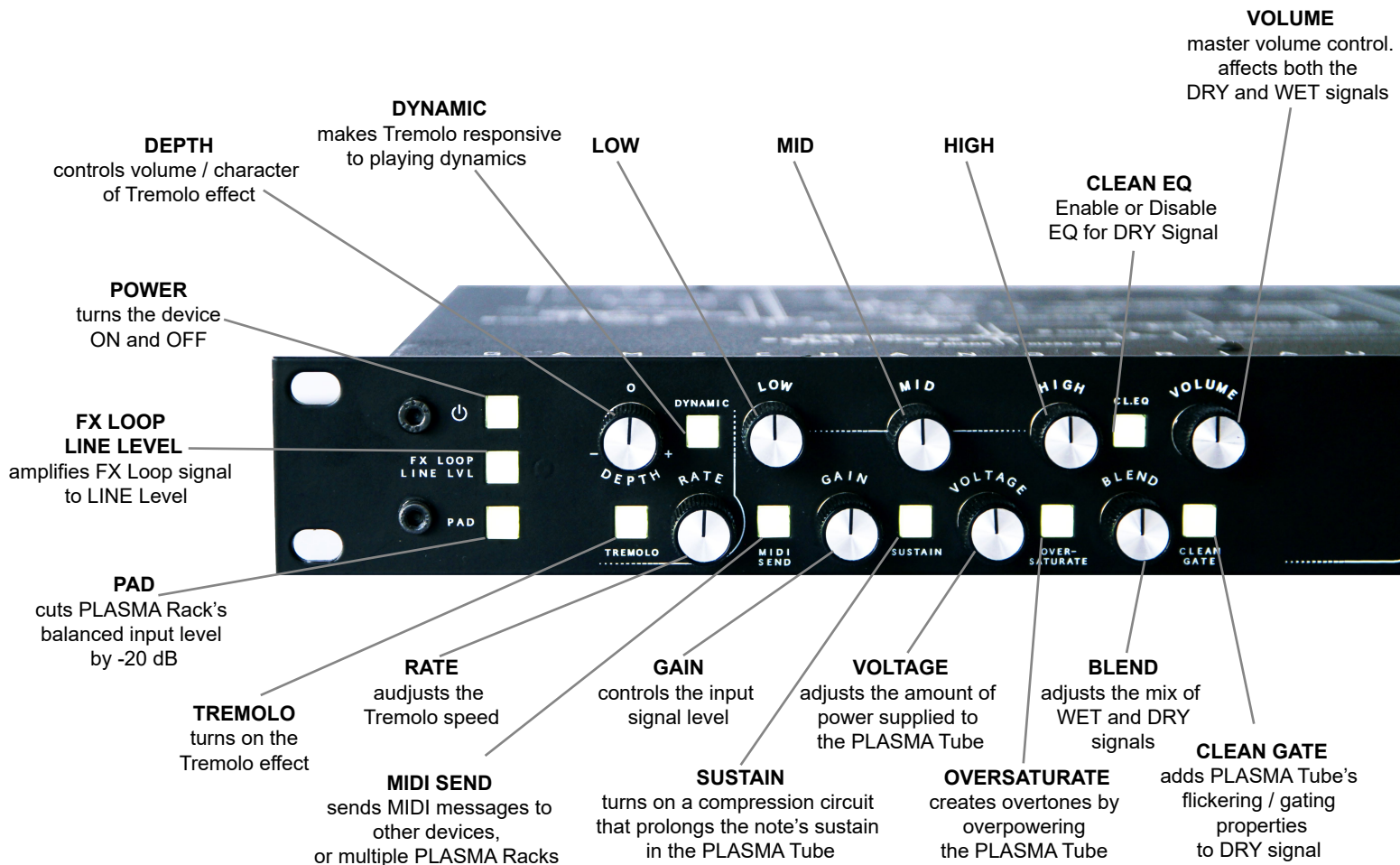

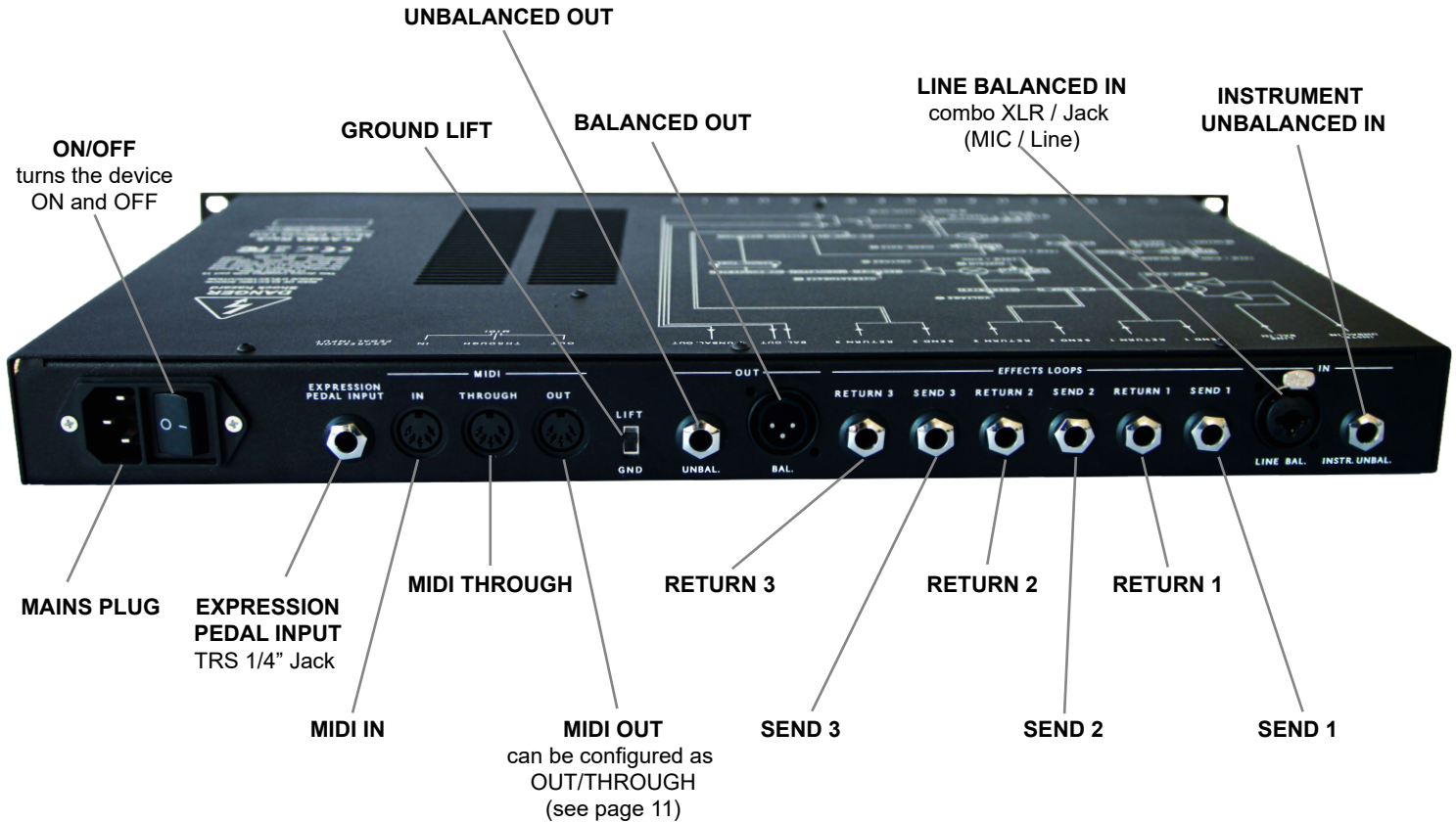

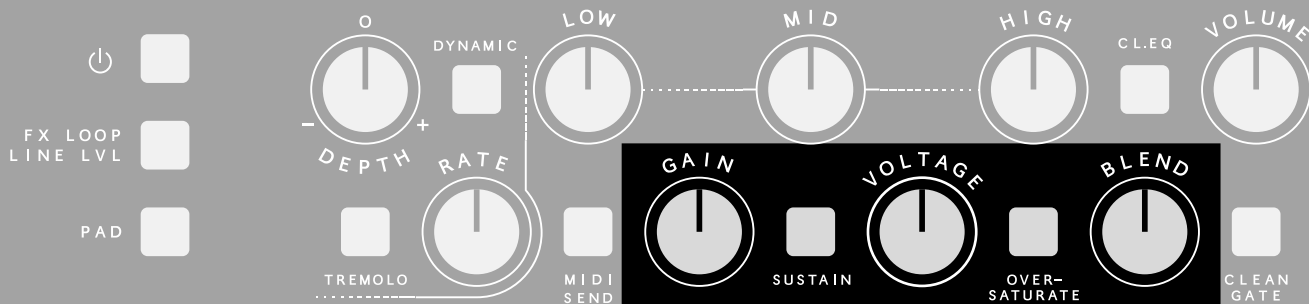

GAIN

Lets you control the level of the input signal coming into the PLASMA Rack.

Use the GAIN knob to adjust input levels for different pickup types or sound sources, to avoid signal clipping, and to achieve balance between WET and DRY signal levels.

The PLASMA Rack will behave differently, depending on the amount of input GAIN: If GAIN is turned all the way down, you will most likely end up underpowering the xenon tube, and there will be no visible discharges in the PLASMA Tube.

To get the most range out of the VOLTAGE knob, adjust the GAIN knob so that when VOLTAGE is turned all the way down there is still a weak, visible electrical discharge in the PLASMA TUBE.

VOLTAGE

Lets you adjust the amount of power supplied to the PLASMA Tube, when Input signal is detected.

At lower VOLTAGE settings the amount of signal necessary to create a discharge in the PLASMA Tube will be higher. In other words - only stronger signals will pass through the TUBE, while weaker signals (including noise, hum, sustain tails) will not be able to travel through the PLASMA Tube. Thus, lower VOLTAGE Settings produce a more dynamic, responsive sound, and the PLASMA Tube's gating properties become more pronounced.

At higher VOLTAGE Settings the PLASMA Tube becomes more reactive to all signal levels. As a result, there is more Saturation, Compression and Sustain, but the Tube's Gating properties become less pronounced.

BLEND

Lets you adjust the mix of WET and DRY signals.

The Distortion produced by the PLASMA Rack is quite radical, therefore Mixing the DRY and WET signals lets you achieve more sound variations.

When BLEND is turned all the way to the left, only the DRY audio can be heard in the output (Gating, EQ, Tremolo set separately).

When turned all the way to the Right, only the WET signal produced by the PLASMA Tube is heard in the output.

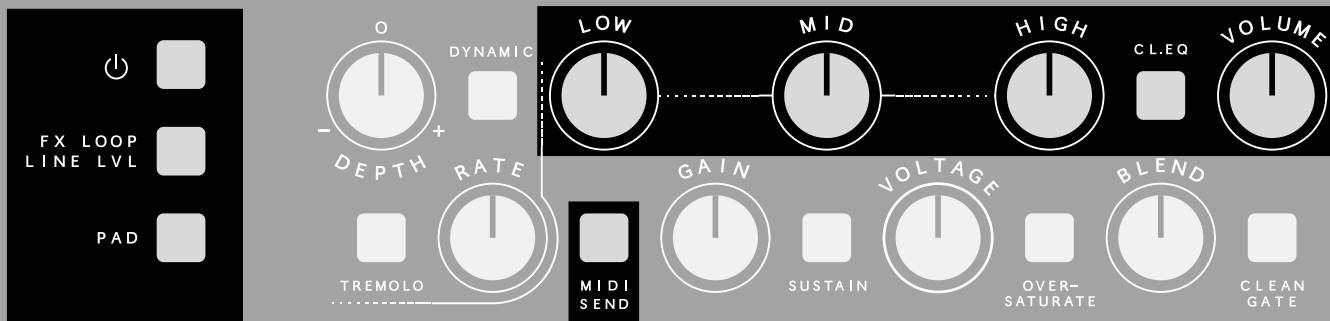

POWER

The **POWER** Button on the **PLASMA Rack's** front Panel puts the device in **Standby mode**, but audio signal still travels through the Rack (**True Bypass**). There is also a Mains Power switch on the **PLASMA Rack's** back panel.

FX LOOP LINE LEVEL

By default all effects units and sound processing devices plugged into the **PLASMA Rack's** FX Loops will operate at **Instrument Level**.

By switching the FX LOOP Line Level button ON, the FX Loop signal will be increased to LINE Level!

PAD

When turned **ON** - the **PLASMA Rack's** balanced input Level will be attenuated by **-20 dB** for increased headroom.

MIDI SEND

when **ON**, the **PLASMA Rack** will start sending **MIDI Information (Front Panel CC Messages)** via the **MIDI Out port**.

EQUALIZER + CLEAN EQ

The **PLASMA Rack** features a **3 knob EQ section** and a **CLEAN EQ button**. When the **CLEAN EQ** Button is switched **OFF** the EQ section will only apply the **WET** signal produced by the **PLASMA Tube**. This is useful when using the **BLEND** Knob to add a heavily EQ'd / Filtered **PLASMA Tube** distortion sound to an otherwise clean signal, for example - adding a high, sizzling **PLASMA** distortion to a warm bass track.

When the **CLEAN EQ** button is switched **ON** both **WET** and **DRY** signals will be filtered.

VOLUME

Master Volume Control - affects the output levels of **DRY** and **WET** signals.

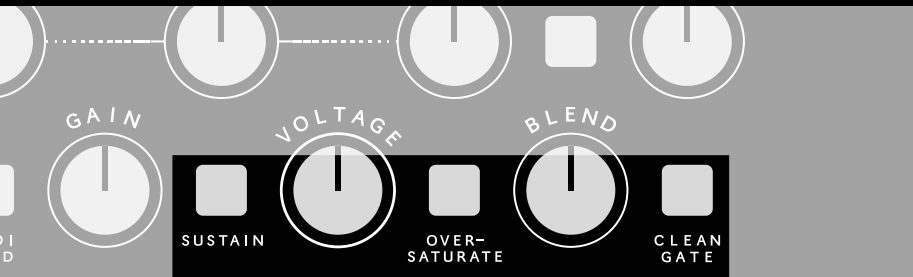

CLEAN GATE

The **CLEAN GATE** button lets you apply the **PLASMA Tube's** flickering / gating properties to your **DRY** signal, without adding any **PLASMA Distortion**.

Turn the **BLEND** Knob all the way to the left, adjust the **VOLTAGE** knob so that the **PLASMA Tube** is barely flickering, and press the **CLEAN GATE** Button.

SUSTAIN

Playing the **PLASMA Rack** at lower **VOLTAGE** settings produces an interesting, deteriorating sound, but the note's sustain length is sacrificed.

Therefore, the **SUSTAIN** Button on the **PLASMA Rack's** front panel switches on a specifically designed compression circuit that helps prolong the note's sustain in the **PLASMA Tube**, while keeping it at the edge of breakup.

At higher **VOLTAGE** settings the **SUSTAIN** mode will keep acting as a subtle compressor, although the effect will be not as pronounced.

OVERSATURATE

The **PLASMA Rack's** **OVERSATURATE** mode is inspired by a rectifier-style Octave-up circuit, but due to the **PLASMA Tube's** unusual properties, the resulting effect is quite different.

Essentially, by switching on the OVERSATURATE mode, the amount of VOLTAGE sent to the PLASMA Tube is radically increased, resulting in a lot of high harmonics.

The **OVERSATURATE** mode is highly reactive to the amount of power sent to the **PLASMA Tube**. At lower **VOLTAGE** settings, the effect will be very subtle, whereas at high **VOLTAGE** settings the signal will be turned into a continuous **PLASMA arc**. As a result, a lot of the audio signal will be completely destroyed or turned into static.

Every instrument or type of signal will have a different **VOLTAGE + OVERSATURATE** sweet-spot.



This effect has a wide range of applications, such as - crushing drums, removing sustain from cymbals, or adding a flickering quality to melodic lines. **CLEAN GATE** can also be used to eliminate Hum and noise from other pedals or effects in the signal chain.

Naturally, the **CLEAN GATE** mode can be used when both **DRY** and **WET** signals are mixed with the **BLEND** Knob, as well as in combination with the **SUSTAIN** and **OVERSATURATE** modes.

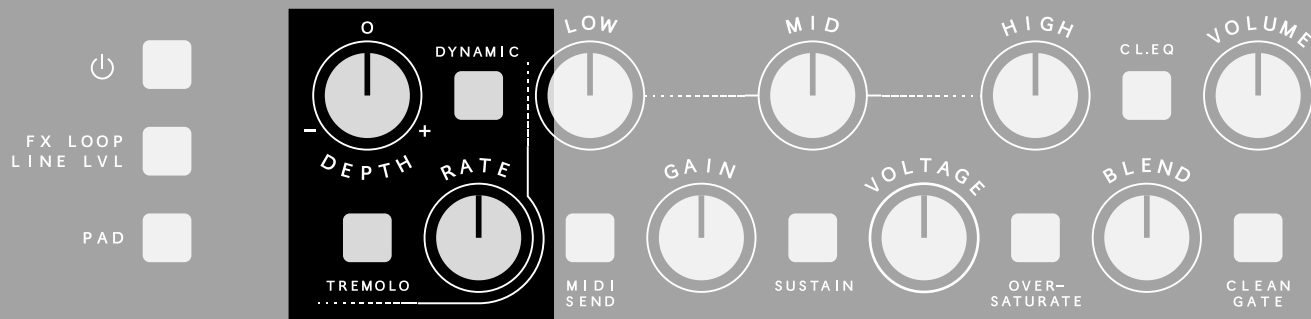

TREMOLO

The **PLASMA RACK** features a diverse **TREMOLO** section that affects both the **DRY** and the **WET** signals.

To start off - set the **BLEND** Knob to the middle position and turn the **TREMOLO** mode **ON**. By adjusting the **DEPTH** knob all the way to the **Right**, you will hear a hard tremolo effect on both the **DRY** and the **WET** signals. By reducing the **DEPTH** knob towards the middle position (marked "0"), the tremolo effect will become softer. When the **DEPTH** knob is turned below the "0" position, the tremolo effect is out of phase - instead of pulsating together, the **DRY** and **WET** signals will now alternate.

The tremolo speed is adjusted by the **RATE** knob. As the **RATE** knob is turned above 12 o'Clock, the pulsation will become so fast that it will enter Ring Mod territory.

TIP:

Use **OVERSATURATION** mode to bring out the high-harmonics produced by the Flickering **PLASMA** Tube.

DYNAMIC

DYNAMIC mode is a special kind of Tremolo effect, specifically designed for the **PLASMA** Rack.

In essence - **DYNAMIC Mode makes the Tremolo Depth sensitive to the dynamics of your playing.**

Turn **DYNAMIC** Mode **ON**, and set the **DEPTH** knob all the way to the **Right**. Now the Tremolo or Ring effect will only be triggered momentarily by loud peaks in the signal, such as strums, drum-hits, note attacks, etc. Other than the transients, most of the signal will stay unaffected.

As you bring the **DEPTH** Control closer to the 12 o'Clock position, the tremolo effect will stay on for a longer time, but it will start disappearing as the signal levels drop.

When the **DEPTH** Control is in turned below 12 o'Clock, the Dynamic effect is reversed - the Tremolo will be triggered as the signal levels drop down. This allows you to Strum a chord and let it ring out for a while, and have the tremolo rise up only on the chord's trails.

Various **GAIN** settings may cause **DYNAMIC** mode to respond differently.

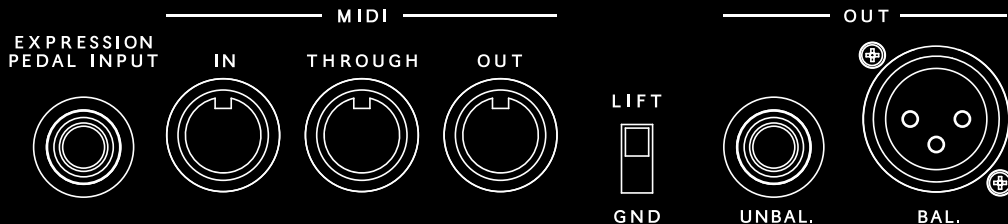
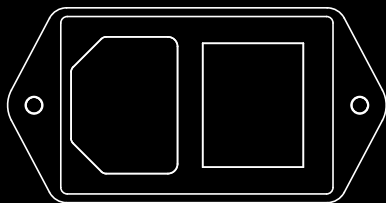

MIDI Ports

The PLASMA Rack has three MIDI Connectors on the back panel - MIDI IN, MIDI OUT, and MIDI THROUGH.

When a MIDI Cable is plugged into the MIDI IN Connector the PLASMA Rack receives MIDI signals automatically, and no additional buttons or settings need to be switched on.

The MIDI THROUGH connection can be used to daisy-chain a MIDI signal to multiple devices.

To Send MIDI Signals from the PLASMA Rack, a MIDI Cable has to be plugged into the PLASMA Rack's MIDI OUT connector, and the MIDI SEND button on the PLASMA Rack's front panel needs to be switched ON.

The MIDI OUT connector can also be configured as a MIDI OUT/THROUGH for more flexible routing possibilities.
For example - using one MIDI cable to send CC messages to other devices, while also passing along MIDI signals from an external controller.



INPUTS and OUTPUTS

The PLASMA Rack features two Inputs:
1 Unbalanced 1/4" TS Jack input (Instrument),
1 Balanced combo XLR / Jack input (Mic/Line)

& two Outputs - Balanced XLR and Unbalanced 1/4" TS Jack

MIDI OUT-THROUGH TOGGLE

While device is OFF
HOLD  + 
(until starts blinking)

To configure MIDI OUT connector as combined MIDI OUT / THROUGH:
PRESS  SUSTAIN
HOLD  TO_SAVE / PRESS  TO_ESC

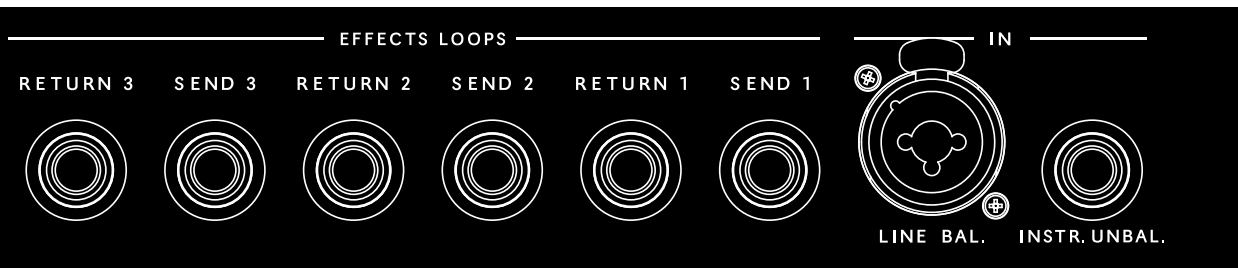

EFFECTS LOOPS

The **PLASMA RACK** offers three FX Loop Send and Return connections. Each FX Loop lets you insert an external effect at a different part of the **PLASMA Rack's** signal chain:

FX Loop 1 will affect the DRY Signal only

FX Loop 2 will affect the WET Signal only,
before it goes into the **PLASMA Tube**

FX Loop 3 will affect the WET Signal only,
after the **PLASMA Tube**.

GROUND LIFT

The ground lift switch disconnects the ground of all signal connectors from the AC Mains safety ground, allowing to break ground loops that may form between equipment connected to the signal chain. Use ground lift if 50/60Hz hum is heard together with audio signal.

CAUTION - at least one of the devices in the signal chain has to be connected to AC Mains safety ground for safety purposes. Failing to do so may result in risk of electrical shock.

All parameters of the PLASMA Rack can be controlled with MIDI - via CC messages and via Program Change messages.

Configuring the PLASMA Rack's MIDI Tx(Transmit) an Rx(Receive) Channels:

- 1) Turn the PLASMA Rack OFF, using the front panel POWER button
- 2) PRESS and HOLD the CLEAN EQ and DYNAMIC buttons until they start blinking
- 3) Now you can configure the MIDI Tx Channel by tapping the OVERSATURATE button a specific number of times - for example, if you wish to set the Rack's MIDI Tx channel to Channel Three, then tap the OVERSATURATE Button 3 times.
- 4) To configure the PLASMA Rack's MIDI Rx Channel - tap the CLEAN GATE button. For example - Rx Channel 4 would mean 4 taps on the CLEAN GATE button.
- 5) To SAVE press and hold the CLEAN EQ button until it blinking stops.
- 6) To exit without saving press the DYNAMIC button.

Any combination of knobs and buttons can be saved on one of PLASMA Rack's eight preset slots.

PRESET SLOTS 1 - 8 are indicated by 8 front panel buttons shown below

To save a preset:

- 1) Configure a Sound that you wish to save on the PLASMA Rack
This includes the positions of all rotary knobs and all sound-related buttons (excl. Power, MIDI Send, PAD, FX LOOP).*
- 2) PRESS and HOLD the MIDI SEND button until it starts blinking.
- 3) You will see that the POWER button is ON, while the MIDI SEND and FX LOOP buttons are blinking (since preset slot 1 is indicated by the FX LOOP button)
Tap the MIDI SEND button to navigate through the remaining 7 Preset slots.
- 4) When you've chosen one of the eight available Preset Slots, PRESS and HOLD the MIDI SEND button to save the Preset.
- 5) To Escape before saving - PRESS the POWER button.

Settings saved as Presets can be recalled by MIDI Program Change messages 01 - 08.
Program Change Message 09 will return the PLASMA Rack to actual front panel settings.

*CLEAN/DRIVE Toggle and EXP Pedal assignment are also saved

UTILITY SETTINGS

While device is OFF
HOLD →  + 
(until starts blinking)

Configure MIDI Tx (Send) and Rx (Receive) Channels by tapping OVERSATURATE and CLEAN GATE
(for ex. 3 taps = Channel 3)

T X 
OVER-SATURATE

R X 
CLEAN GATE

HOLD  TO_SAVE / PRESS  TO_ESC

SAVE MIDI PRESETS

While device is OFF
HOLD → 
(until starts blinking)

Scroll through 8 preset slots by tapping 

Preset slots 1- 8:

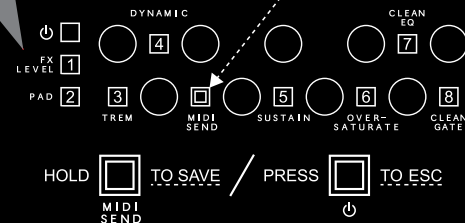



EXPRESSION PEDAL ASSIGN

While device is OFF
 HOLD → (until starts blinking)



PAD

Choose any potentiometer to control with the pedal:

Turn the knob to Min: then to Max:

HOLD TO SAVE (temporarily) / PRESS TO ESC

HOLD + TO SAVE (permanently)

The **PLASMA Rack** features a TRS input for any standard Foot-controlled Expression pedal. By default, the EXP Pedal input is assigned to control the Rate of the PLASMA Rack's Tremolo effect, but this can be reassigned (permanently or temporarily) to any rotary potentiometer on the PLASMA Rack's front panel - for example: Volume, Blend, Voltage, Tremolo Depth, etc.

Reassigning the EXP Input:

- 1) Make sure that the PLASMA Rack is ON
- 2) PRESS and HOLD the PAD Button until it starts blinking.
- 3) While PAD is blinking, turn the desired knob to the MINIMUM position.
- 4) Then turn the same knob to the MAXIMUM Position.

Temporary save (resets on reboot)

- 5) Without touching any other knobs PRESS and HOLD PAD to save the EXP Input parameter Temporarily (until reboot).

Permanent save (becomes default setting)

- 6) Without touching any other knobs PRESS and HOLD the PAD & CLEAN GATE buttons
- 7) To exit EXP Pedal assign mode without saving - PRESS the POWER button.

By default - all buttons on the PLASMA Rack's front panel are in the OFF state when the Rack is turned ON. However, if you know that you are going to use a specific set of functions for multiple sessions in a row, **you can easily configure the default start-up states of the following buttons:**



- 1) PRESS and HOLD the FX LOOP LINE Level button until it starts blinking
- 2) Configure the desired default states of the buttons above
- 3) To Save PRESS and HOLD the FX LOOP LINE Level button
- 4) To Escape without saving - PRESS the POWER Button

NB! Saving default button states will also save the CLEAN/DIRTY Blend setting (see next page).

Default Button States for Utility Settings

The default states of the four remaining Front panel buttons can also be configured:

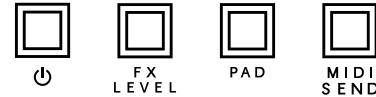

This includes the POWER ON button - for example, if you want the Rack to turn on automatically, as soon as the Power switch on the Back panel is switched on (or mains plugged in)

- 1) While the Device is OFF - PRESS and HOLD the CLEAN EQ & DYNAMIC Buttons until they start blinking.
- 2) Now you can configure the default states of the buttons above.
- 3) To Save, PRESS and HOLD the CLEAN EQ Button.
- 4) To Escape without saving Press DYNAMIC

DEFAULT BUTTON STATES

While device is OFF
HOLD → (until starts blinking)



Set default state for:



HOLD TO_SAVE / PRESS TO_ESC

UTILITY SETTINGS

While device is OFF
HOLD → (until starts blinking)



Set default state for:



HOLD TO_SAVE / PRESS TO_ESC

DRY SIGNAL - CLEAN / DIRTY toggle.

By default the PLASMA Rack's BLEND Knob lets you mix between the WET signal produced by the PLASMA distortion and the DRY unaffected signal (EQ optional). However, there is a built-in gainstage that the PLASMA Rack uses to overdrive and compress the clean input signal before it gets sent into the PLASMA Tube.

If so desirable - you can configure the PLASMA Rack's BLEND knob to Mix between the WET signal produced by the PLASMA Tube and the Overdriven WET Signal from the PLASMA Tube's Gainstage.

To toggle the BLEND knob from CLEAN to DIRTY

- 1) PRESS and HOLD the SUSTAIN & CLEAN GATE Buttons until the OVERSATURATE button starts blinking.
- 2) Now the left side of the BLEND control will mix in an Overdriven signal.
- 3) To return to CLEAN Blend - repeat the SUSTAIN & CLEAN GATE Long-Press.

FACTORY RESET

To return to the Factory settings and erase all saved presets follow these steps:

- 1) Switch the device OFF (using the front panel POWER switch)
- 2) PRESS and HOLD the following 3-button combination until it starts blinking:



- 3) To Complete the Factory Reset PRESS & HOLD the PAD + CLEAN GATE buttons
- 4) To Escape without completing the Factory Reset - PRESS the POWER Button

CLEAN/DIRTY BLEND TOGGLE

While device is ON
HOLD → (until starts blinking)



RESET TO FACTORY DEFAULT

While device is OFF
HOLD → (until starts blinking)



Since PLASMA Rack is a MONO device, to achieve a true Stereo setup, you can use two PLASMA Rack Units, one for each channel.

All knob and button positions can be synchronised and adjusted on both racks via MIDI CC messages.

In the following example - RACK 1 is connected to send MIDI CC messages to RACK 2.

When you turn ON the MIDI SEND Button on the Front Panel of RACK 1 - all knob and button adjustments made on RACK 1 will be automatically repeated on RACK 2.

When an additional **MIDI Controller** is added to the setup, all **Program Change Messages** will affect **ONLY PLASMA RACK 1**, unless the MIDI OUT connector on RACK 1 is set up as MIDI OUT/THROUGH (see page 11).

All knob changes performed by an Expression Pedal connected to RACK 1, will be repeated on RACK 2 **ONLY**, if the MIDI SEND Button on RACK 1 is ON.



IO:**Unbalanced input:**

| | |
|---------------------------------|---|
| Connector | Tip-Sleeve ¼" Jack |
| Impedance | 1 MΩ |
| Maximum input level | + 11 dBu |
| Maximum undistorted input level | 0 dBu (Gain setting at minimum) |
| Type | Instrument input, RF filtered, true bypass to unbalanced output |

Balanced input:

| | |
|---------------------------------|---|
| Connector | Combo connector: Female XLR and Tip-Ring-Sleeve ¼" (Pin 2 and Tip hot) |
| Impedance | 4.38 kΩ 1.5 kΩ (PAD switch on) |
| Maximum input level | +17 dBu (Clamped by protection devices) +37 dBu (PAD switch on, clamped by protection devices) |
| Maximum undistorted input level | +2dBu (Gain setting at minimum) +22 dBu (PAD switch on, Gain setting at min) |
| Type | Mic/Line input, RF filtered, true bypass to balanced output |

Unbalanced output:

| | |
|----------------------|--------------------|
| Connector | Tip-Sleeve ¼" Jack |
| Impedance | 220Ω |
| Maximum output level | +7 dBu |

Balanced output:

| | |
|----------------------|----------------------|
| Connector | Male XLR (Pin 2 Hot) |
| Impedance | 200 Ω |
| Maximum output level | + 10 dBu |

FX loop send (1-3):

| | |
|----------------------|---|
| Connector | Tip-Sleeve ¼" Jack |
| Impedance | 100 Ω |
| Maximum output level | +12 dBu (Line level) -6 dBu (Instrument level) |

FX loop return (1-3):

| | |
|---------------------|--------------------|
| Connector | Tip-Sleeve ¼" Jack |
| Impedance | 1 MΩ |
| Maximum input level | +14 dBu |

MIDI in/out/through:

| | |
|-----------|---------------------------------------|
| Connector | 5-pin DIN (180 degree) |
| Type | Optically isolated input, RF filtered |

Expression pedal:

| | |
|-----------|---|
| Connector | Tip-Ring-Sleeve ¼" (Wiper tip, CCW ring, CW sleeve) |
| Type | Designed for potentiometer-based expression pedals, RF filtered |

Gain and signal levels:

| | |
|---------------------------------|---|
| Preamp gain range | -26 to +12 dB |
| Unbalanced input | recommended level for 0dB gain setting: -15 dBu |
| Balanced input (PAD switch off) | recommended level for 0dB gain setting: -9 dBu |
| Balanced input (PAD switch on) | recommended level for 0dB gain setting: +11 dBu |
| FX loop level (Line) | +4 dBu at recommended input level |
| FX loop level (Instrument) | -15 dBu at recommended input level |
| Volume control gain | -80 to +12 dB |
| PAD attenuation | -20 dB, applies for balanced input only |

EQ:

| | |
|----------------|---|
| Low frequency | 10 Hz, -20 to 20 dB Low-pass shelving filter |
| Mid frequency | 600 Hz, -6 to 6 dB |
| High frequency | 20 kHz, -10 to 10 dB, High-pass shelving filter |
| Type | Baxandall, MIDI controllable |

Tremolo:

| | |
|---------------|--|
| Rate range | 0.85 to 2600 Hz |
| Depth control | 0 – 100%, in (positive range) or out (negative range) of phase between clean and distorted signals |

Tube:

| | |
|-------------------|--------|
| Gas | Xenon |
| Discharge voltage | 5.5 kV |

System performance:

| | |
|-----------------------|--|
| Frequency Response | 30 Hz to 20 kHz (± 3 dB) |
| Signal to Noise Ratio | 69 dB clean channel (A weighted); 78 dB drive channel (A weighted); |
| Operating Temperature | 0° to 40° C |

Power supply:

| | |
|-------------------|--------------------------|
| Type | Universal, switch – mode |
| Operating voltage | 90 – 245 VAC, 50/60 Hz |
| Power consumption | 60 W |

Physical:

| | |
|-------------------------|-----------------------------------|
| Dimensions | 440mm (W) x 255mm (D) x 40mm (H) |
| Shipping box dimensions | 540mm (W) x 380mm (D) x 100mm (H) |
| Weight | 4.1 kg |
| Shipping weight | 4.5 kg |

WARRANTY AND RETURNS

You have a 30 day return period when you may return the product and receive a full refund. You will only be responsible for return shipping charges.

Each PLASMA Rack manufactured by GAMECHANGER AUDIO is warranted to be free from defects in materials and workmanship for one year from the date of shipping or longer if required by the relevant legislation.

This warranty shall not apply to any unit which in the opinion of the manufacturer has been used improperly or has been mechanically or otherwise damaged by accident, misuse or negligence or has been altered or repaired in such a way to impair performance, nor shall it apply to cosmetic defects (considered normal wear and tear)

Other parts, such as knobs, rubbers, cable connectors, are non-replaceable. The manufacturer reserves the right to make changes in design or construction of this equipment without obligation to install similar changes in equipment already sold.

For returns and warranty contact:

GAMECHANGER AUDIO
AISTERES STREET 6
RIGA, LATVIA, LV-1007
INFO@GAMECHANGERAUDIO.COM
WWW.GAMECHANGERAUDIO.COM
+1 202 407 9741



FCC Compliance:

USA:

Federal Communications Commission United States Class A Manual Statement Note:

This equipment has been tested and found to comply with the limits for a Class A digital device pursuant to Part 15 of the FCC Rules. These limits are designed to provide reasonable protection against harmful interference when the equipment is operated in a commercial environment.

This equipment generates, uses, and can radiated radio frequency energy and, if not installed and used in accordance with the instruction manual, may cause harmful interference to radio communications.

Operation of this equipment in a residential area is likely to cause harmful interference in which case the user will be required to correct the interference at his own expense. Any modifications to the unit, unless expressly approved by Gamechanger Audio, could void the User's authority to operate the equipment.

CA:

This Class A digital apparatus complies with Canadian ICES-003.

Cet appareil numérique de la classe A est conforme à la norme NMB-003 du Canada.

CAN ICES3
(A)/NMB-3(A)



This device complies with part 15 of the FCC Rules. Operation is subject to the following two conditions: (1) This device may not cause harmful interference, and (2) this device must accept any interference received, including interference that may cause undesired operation.

Designed and manufactured in Latvia by **Gamechanger Audio Ltd.**

Continuous Control Message definitions

| Potentiometers: | CC | CC value range | MSB / LSB |
|-----------------|----|----------------|---------------|
| EQ LOW | 14 | 0 - 1023 | CC 14 / CC 46 |
| EQ MID | 15 | 0 - 1023 | CC 15 / CC 47 |
| EQ HI | 20 | 0 - 1023 | CC 20 / CC 52 |
| VOLUME | 07 | 0 - 1023 | CC 07 / CC 39 |
| RATE | 01 | 0 - 1023 | CC 01 / CC 33 |
| DEPTH | 24 | 0 - 1023 | CC 24 / CC 56 |
| INPUT GAIN | 21 | 0 - 1023 | CC 21 / CC 53 |
| VOLTAGE | 22 | 0 - 1023 | CC 22 / CC 54 |
| BLEND | 23 | 0 - 1023 | CC 23 / CC 55 |

| Switches: | CC | CC value range |
|----------------------|----|----------------------------------|
| OVERSATURATE | 25 | 0 - 63 = off; 64 - 127 = on |
| CLEAN GATE | 26 | 0 - 63 = off; 64 - 127 = on |
| PAD | 27 | 0 - 63 = off; 64 - 127 = on |
| DYNAMIC | 28 | 0 - 63 = off; 64 - 127 = on |
| TREMOLO | 29 | 0 - 63 = off; 64 - 127 = on |
| SUSTAIN | 30 | 0 - 63 = off; 64 - 127 = on |
| CLEAN EQ | 31 | 0 - 63 = off; 64 - 127 = on |
| CLEAN / DRIVE TOGGLE | 85 | 0 - 63 = clean; 64 - 127 = dirty |
| BYPASS | 86 | 0 - 63 = off; 64 - 127 = on |
| MUTE | 87 | 0 - 63 = off; 64 - 127 = on |

CC 119 is reserved for TREMOLO RATE sync between multiple PLASMA Racks

Program Change Message definitions

| Presets: | PC |
|------------------|----|
| PRESET 1 | 01 |
| PRESET 2 | 02 |
| PRESET 3 | 03 |
| PRESET 4 | 04 |
| PRESET 5 | 05 |
| PRESET 6 | 06 |
| PRESET 7 | 07 |
| PRESET 8 | 08 |
| READ FRONT PANEL | 09 |

| Switches: | PC |
|---------------------|----|
| OVERSATURATE ON | 10 |
| OVERSATURATE OFF | 11 |
| OVERSATURATE TOGGLE | 12 |
| CLEAN GATE ON | 13 |
| CLEAN GATE OFF | 14 |
| CLEAN GATE TOGGLE | 15 |
| PAD ON | 16 |
| PAD OFF | 17 |
| PAD TOGGLE | 18 |

Switches:

| | PC |
|-----------------------------|----|
| DYNAMIC ON | 19 |
| DYNAMIC OFF | 20 |
| DYNAMIC TOGGLE | 21 |
| TREMOLO ON | 22 |
| TREMOLO OFF | 23 |
| TREMOLO TOGGLE | 24 |
| SUSTAIN ON | 25 |
| SUSTAIN OFF | 26 |
| SUSTAIN TOGGLE | 27 |
| CLEAN EQ ON | 28 |
| CLEAN EQ OFF | 29 |
| CLEAN EQ TOGGLE | 30 |
| CLEAN/ <u>DRIVE</u> | 31 |
| <u>CLEAN</u> / <u>DRIVE</u> | 32 |
| CLEAN/ <u>DRIVE</u> TOGGLE | 33 |
| RACK TRUE BYPASS ON | 34 |
| RACK TRUE BYPASS OFF | 35 |
| RACK TRUE BYPASS TOGGLE | 36 |
| MUTE ON | 37 |
| MUTE OFF | 38 |
| MUTE TOGGLE | 39 |

Notice!

- Read these instructions.
- Keep these instructions.
- Heed all warnings.
- Follow these instructions.
- Do not use this apparatus near water.
- Clean only with dry cloth.
- Do not block ventilation openings; install in accordance with manufacturer's instructions.
- Do not install near any heat sources such as radiators, heat registers, stoves, or other apparatus (including amplifiers, pre amps, tube compressors) that produce heat.
- Do not defeat the safety purpose of the polarized or grounded type plug. A polarized plug has two blades with one wider than the other. A grounding type plug has two blades and a third grounding prong. The wide blade and prong are for your safety. If the provided plug does not fit in your outlet, consult an electrician for replacement of the obsolete outlet.
- Protect power cord from being walked on or pinched.
- Use only attachments/accessories specified by the manufacturer.
- Unplug this apparatus during lightning storms or when unused for long periods of time.
- Refer all servicing to qualified service personnel. Service is required when the apparatus has been damaged in any way, such as by being dropped, exposed to rain, liquid being spilled on it, or otherwise does not operate normally.

Service

- There are no user serviceable parts inside.
- All service must be performed by qualified personnel.

Caution

- You are cautioned that any change or modification not expressly approved in this manual could void your authority to operate this equipment.

Warning!

- To reduce the risk of fire or electrical shock, do not expose this equipment to dripping or splashing water and ensure that no objects such as vases are placed on the equipment.
- This apparatus must be earthed.
- Use a three-wire grounding-type line cord like the one supplied with this product.
- Be aware that different operating voltages require the use of different types of line cords and attachment plugs.
- This equipment should be installed near the socket outlet and disconnection of the device should be easily accessible.
- To completely disconnect from AC mains, disconnect the power supply cord from the AC receptacle.
- Do not install in a confined space.
- Do not open the unit -risk of electrical shock inside.

THE PLASMA Rack is a HIGH-VOLTAGE electric device!
This means you SHOULD NEVER under any circumstances attempt to disassemble the unit or to remove any of the device's parts. Do not remove any screws from the Rack's back and top panels. Never attempt to insert foreign objects (such as guitar picks, strings, sharp objects) between the seams in the device's casing.



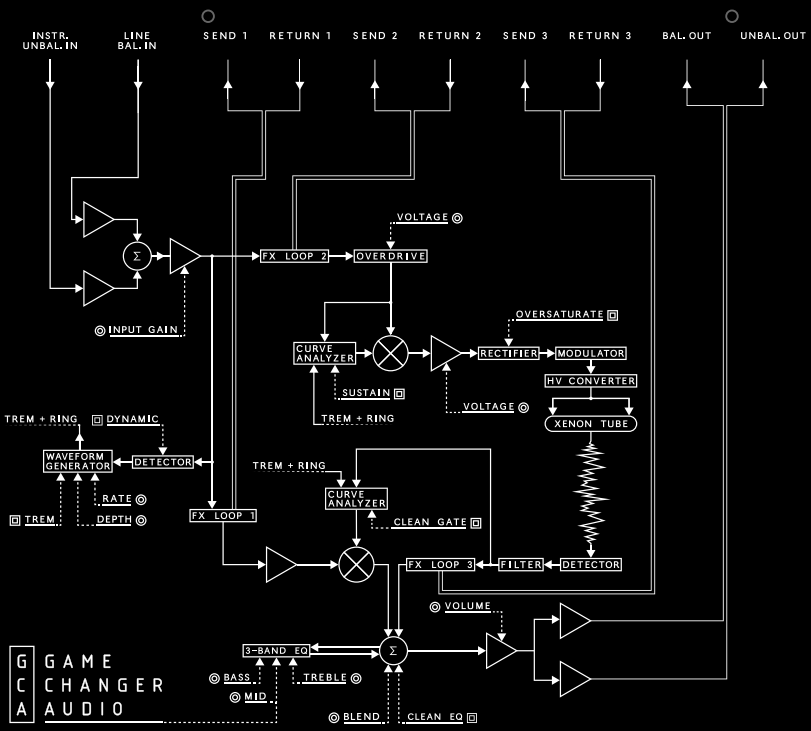

PLASMA RACK

HIGH VOLTAGE DISTORTION UNIT

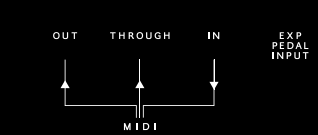

EXPRESSION PEDAL ASSIGN

While device is OFF
 HOLD (until starts blinking) → PAD

Choose any potentiometer to control with the pedal.

Turn the knob to Min: then to Max:

DEFAULT BUTTON STATES

While device is OFF
 HOLD (until starts blinking) → LEVEL

Set default state for:

| | | | | | |
|--|--|--|--|--|--|
| | | | | | |
|--|--|--|--|--|--|

HOLD TO SAVE / PRESS TO.ESC

RESET TO FACTORY DEFAULT

While device is OFF
 HOLD (until starts blinking) → + +

HOLD + TO SAVE / PRESS TO.ESC

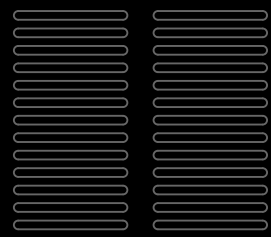

SAVE MIDI PRESETS

While device is OFF
 HOLD (until starts blinking) → MIDI SEND

Scroll through 8 preset slots by tapping MIDI SEND

Preset slots 1-8:

| | | | |
|-------|--|--|--|
| | | | |
| LEVEL | | | |
| PAD | | | |
| | | | |

HOLD TO SAVE / PRESS TO.ESC

CLEAN/DRIVE BLEND TOGGLE

While device is ON
 HOLD (until starts blinking) → +



CAUTION
 RISK OF ELECTRIC SHOCK
 DO NOT OPEN

